

■テクニカルデータ/Technical Data■	
保護等級/Protection class	IP67
温度範囲/Operating temperature	-40°C~+105°C
締め付けトルク/Recommended torque	1.0N・m(10kgf・cm)
※熱抵抗値/Thermal resistant rate	1.63°C/W

※熱抵抗値算出の条件/Thermal resistance test condition

- ・自然空冷/Ambient air cooling
- ・フィンが地面に垂直で温度上昇60°Cの時/Heat-sink fins are set perpendicular to the ground with temperature at 60°C
- ・押し出しがアルマイト品/Anodized extruded aluminium
- ・全面素子/Heat source is applied on the opposite side (inner side) of the fins

構成内容 / Components				
No.	名称 / Part name	数量 / Pcs	材質 / Material	色・表面処理 / Color・Finish
1	フランジ付側板/Flanged end panel	2	ADC12/Diecast aluminiumADC12	シルバー・ブラック・塗装(内面未処理)/Silver,black・Painted (unfinished inside)
2	ボディフレーム/Body frame	1	アルミ押出材/Extruded aluminium A6063S-T5	シルバー・アルマイト・ブラックアルマイト/Silver,black・Anodized
3	シールドガスケット/Conductive gasket	2	導電性シリコン/Conductive silicone	ブラック/Black
4	取付ビス/Screw	8	ステンレス(パイント)M4×12/Stainless steel	無処理/Unfinished

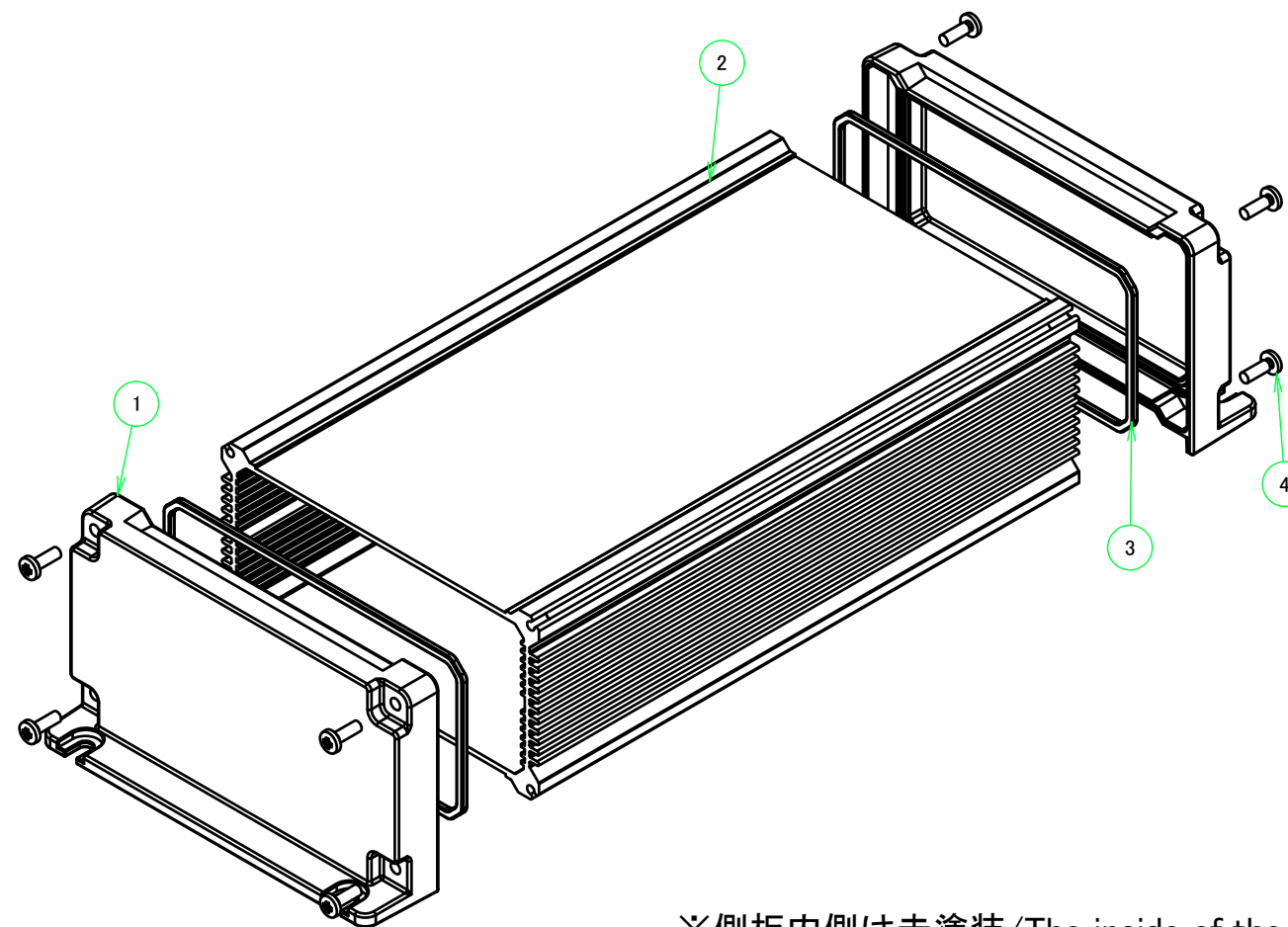
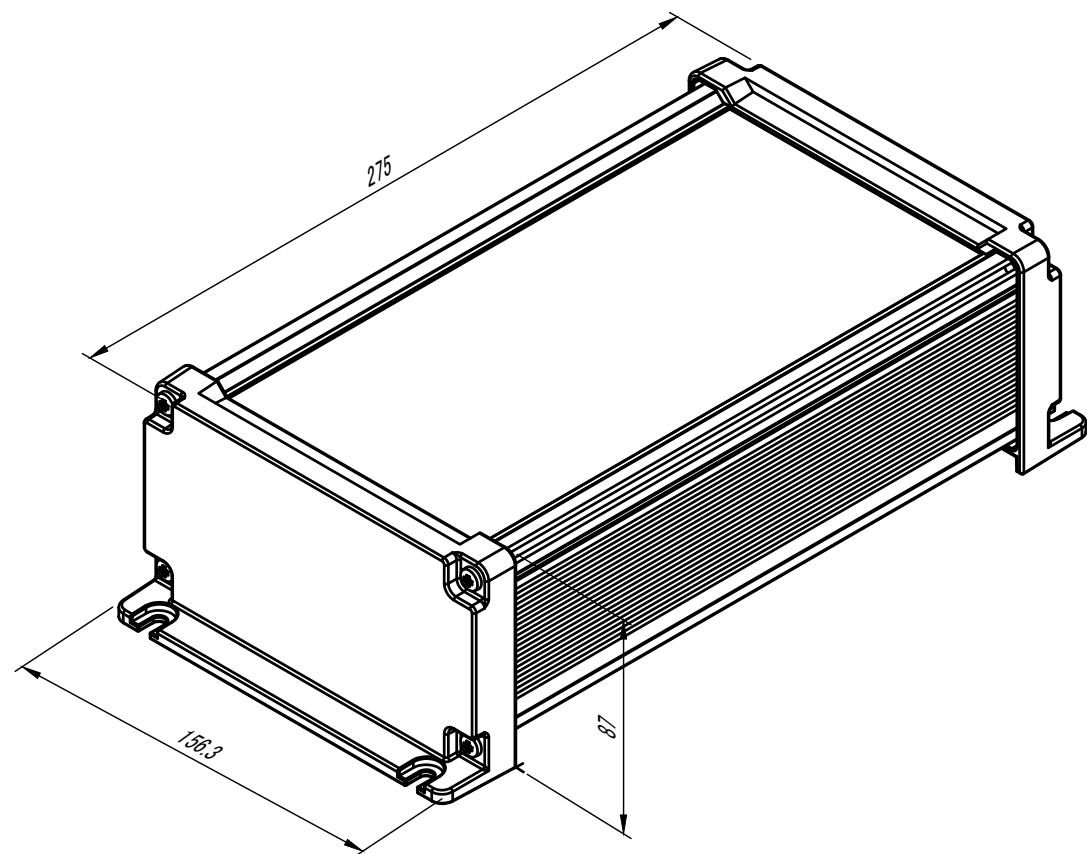

※側板内側は未塗装/The inside of the end panels are unpainted for shielding

色仕様(型番末尾□□)/Color type		
記号/Code	パネル/Panel	ボディフレーム/Body frame
SS	シルバー/Silver	シルバー/Silver
BS	ブラック/Black	シルバー/Silver
BB	ブラック/Black	ブラック/Black

<b>TAKACHI</b> 株式会社タカチ電機工業 TAKACHI ELECTRONICS ENCLOSURE CO., LTD.		品名/Title フランジ足付防水・防塵アルミケース IP67 FLANGED ALUMINIUM ENCLOSURE	 尺度/Scale 1 : 2.5
承認/Approved	検図/Checked	製図/Created	
	王	岡本	型番/Product number AW16-9-28E□□
作成日/Date 2017/06/28			1 / 4

フランジ付側板1  
Flanged end panel 1

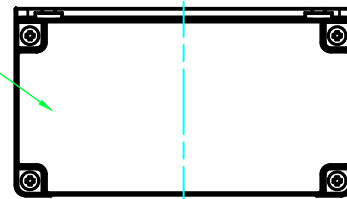

B-B (1:3.5)

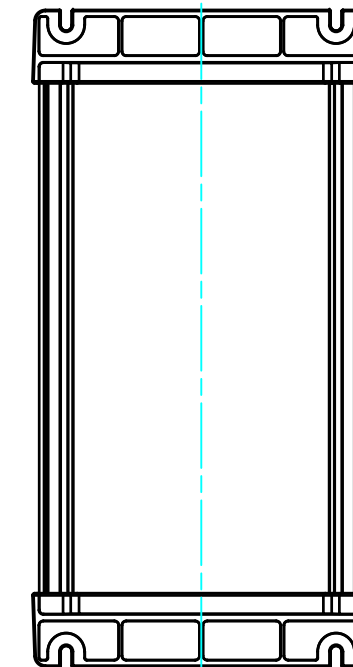
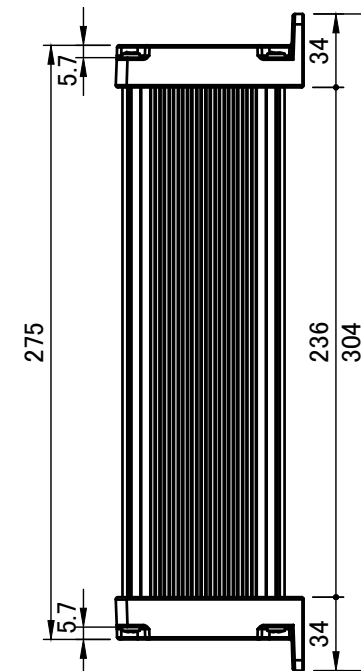
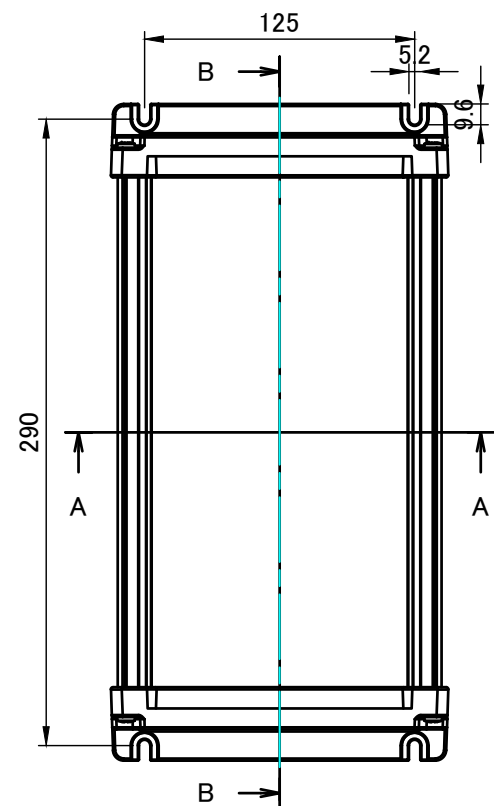
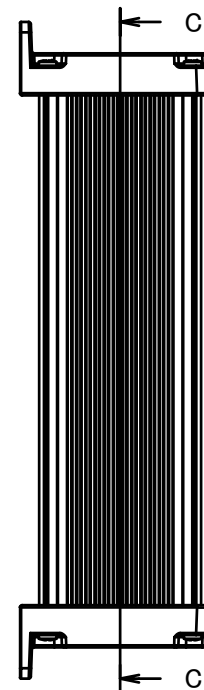
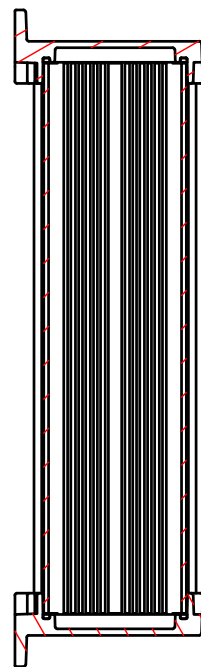

フランジ付側板2  
Flanged end panel 2

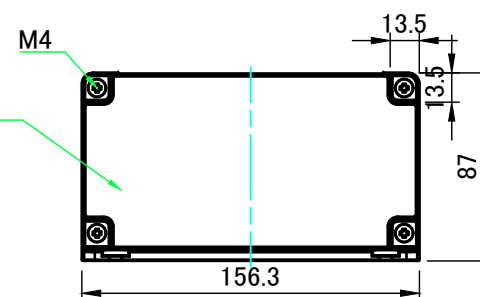

A-A (1:3.5)

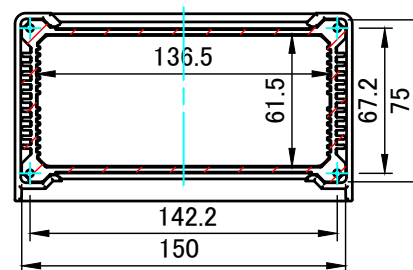

C-C (1:3.5)

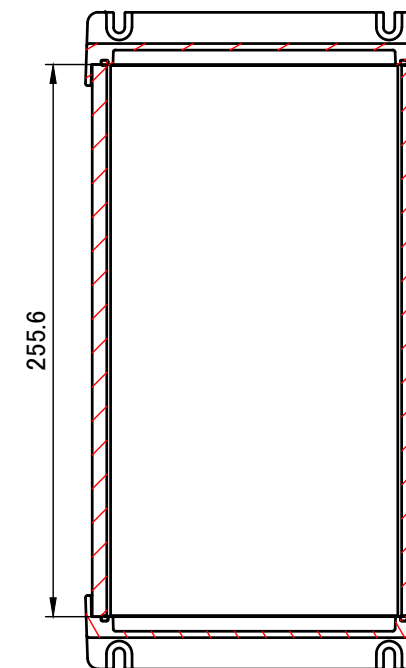

<b>株式会社タカチ電機工業</b> TAKACHI ELECTRONICS ENCLOSURE CO., LTD.		品名/Title <b>フランジ足付防水・防塵アルミケース</b> IP67 FLANGED ALUMINIUM ENCLOSURE	尺度/Scale 1 : 3.5	
承認/Approved	検図/Checked	製図/Created		型番/Product number <b>AW16-9-28E□□</b>
	王	岡本	作成日/Date 2017/07/14	2 / 4

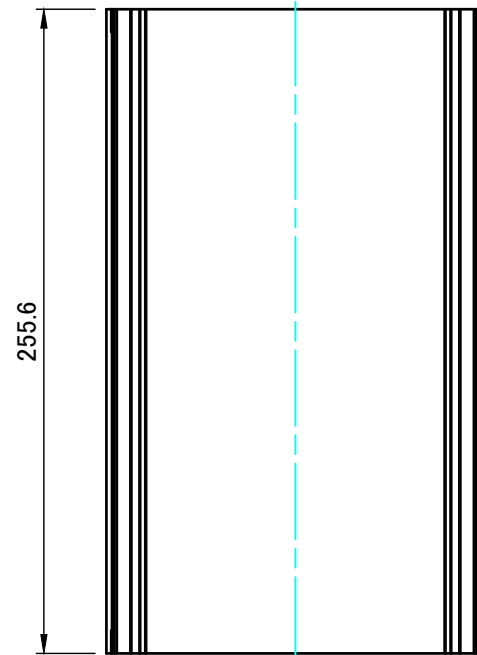
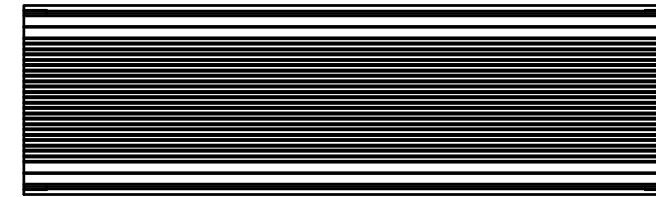
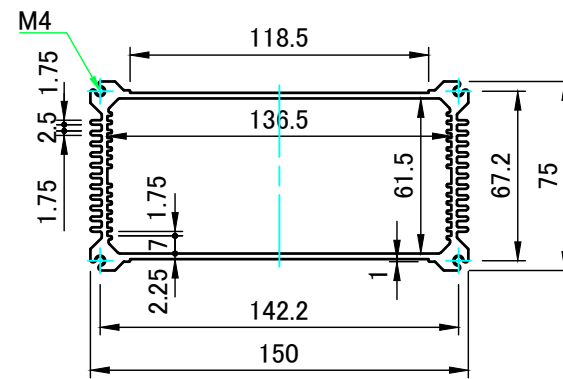
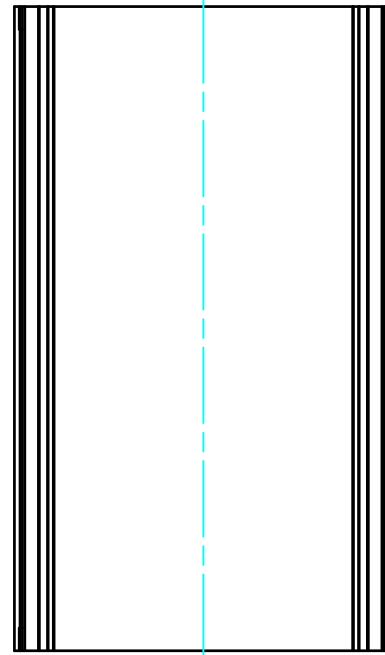
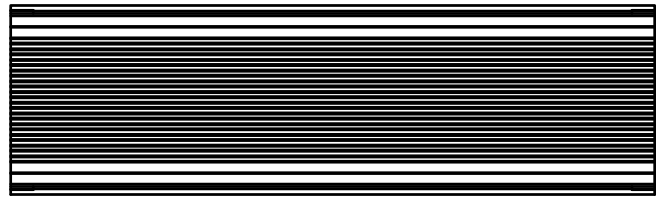

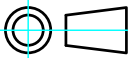
 株式会社タカチ電機工業 TAKACHI ELECTRONICS ENCLOSURE CO., LTD.		品名/Title ボディフレーム Body frame	
承認/Approved	検図/Checked	製図/Created	
	王	岡本	作成日/Date 2017/07/18
			尺度/Scale 1 : 3
			3 / 4

フランジ付側板1  
Flanged end panel 1

A-A (1:2.5)

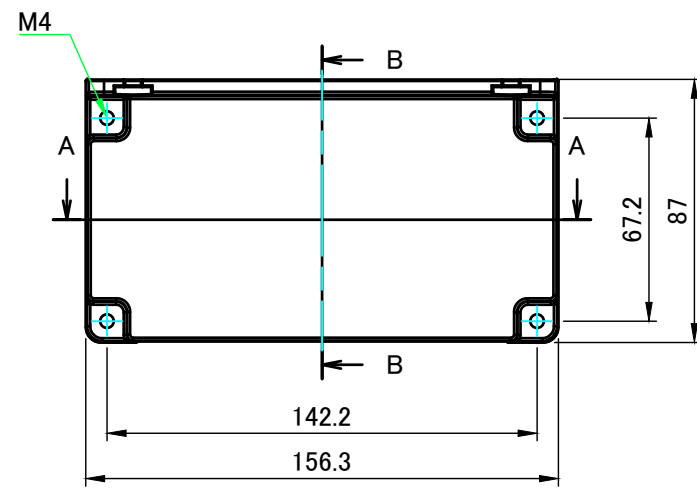
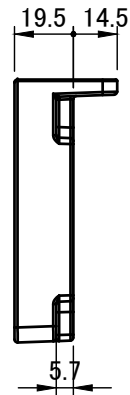
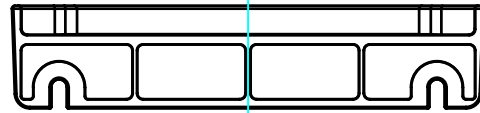
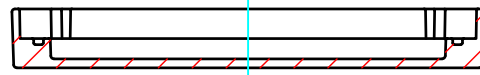

B-B (1:2.5)

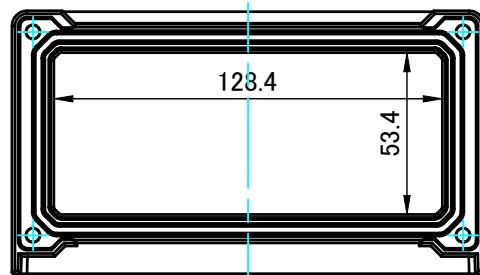
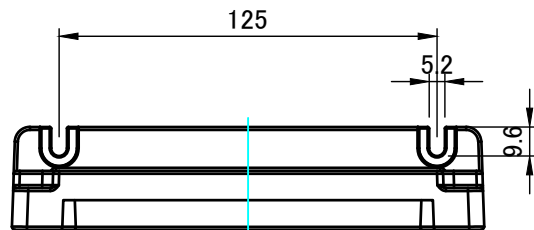
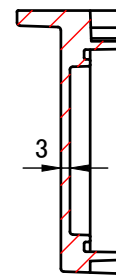

フランジ付側板2  
Flanged end panel 2

C-C (1:2.5)

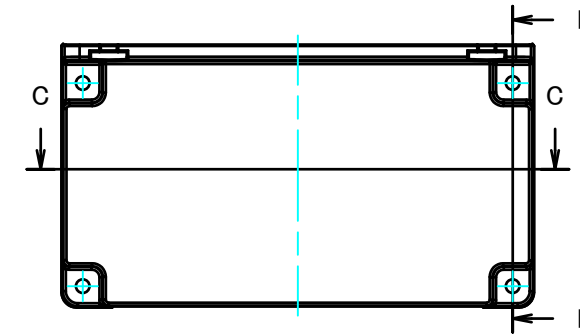
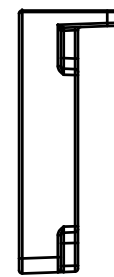
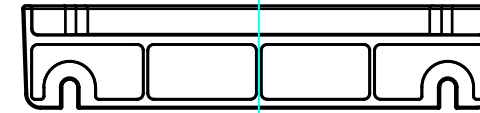
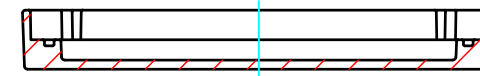

D-D (1:2.5)

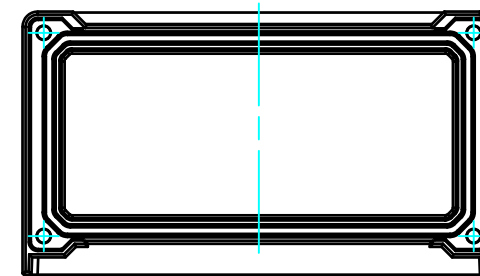
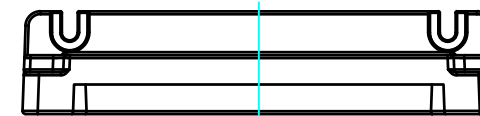
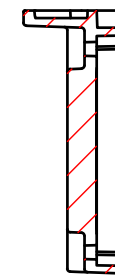

<b>株式会社タカチ電機工業</b> TAKACHI ELECTRONICS ENCLOSURE CO., LTD.		品名/Title <b>フランジ付側板</b> Flanged end panel	尺度/Scale 1:2.5
承認/Approved	検図/Checked	製図/Created	
	王	岡本	作成日/Date 2017/07/19
			4 / 4