

Circuit Breaker for Equipment thermal, 2 pole, Rocker actuation



### Description

- Thermal circuit breaker
- 1 or 2 pole thermal overload protection
- Positively trip-free release
- High configurability
- Rocker non-illuminated or illuminated
- Snap-in version
- Quick connect terminal 6.3 x 0.8 mm or screw clamp terminal M3.5 x 6 mm (lineside P1, P2)

### Approvals

- Approval Reference Type: TA45
- IEC Standard: IEC 60934
- UL Standard: UL 1077
- CSA Standard: CSA C22.2 235
- GB Standard: GB 17701

### Applications

- Power tools
- Industrial appliances
- Power supplies

### Weblinks

[pdf-datasheet](#), [html-datasheet](#), [General Product Information](#), [Approvals](#), [CE declaration of conformity](#), [RoHS](#), [CHINA-RoHS](#), [REACH](#), [e-Shop](#), [SCHURTER-Stock-Check](#), [Distributor-Stock-Check](#), [Detailed request for product](#), [Product News](#)

### Technical Data

Rated Voltage AC	240 V
Rated Voltage DC	60 V
Rated current range AC	0.05 - 20 A
Conditional short circuit capacity	IEC: Inc, PC1, AC 240 V: 1 kA
Degree of Protection	from front side IP 40 acc. to IEC 60529
Dielectric Strength	4 kVAC
Insulation resistance	500VDC > 100 MΩ
Endurance typical	mechanical: 50'000 switching cycles AC: 1 x Ir: 50'000 switching cycles DC: 1 x Ir: 50'000 switching cycles

Overload	AC: min. 40trips @ 6 x Ir DC: min. 40trips @ 4 x Ir
Ambient temperature	-10°C to 55°C
Vibration Resistance	± 0.75 mm @ 5 - 60 Hz acc. to IEC 60068-2-6, test Fc 10 G @ 60 - 500 Hz acc. to IEC 60068-2-6, test Fc
Shock Resistance	30 G / 18ms acc. to IEC 60068-2-27, test Ea
Tripping Type	Thermal
Actuation type	Rocker
Weight	30 - 35g

### Dimension

Quick connect terminal

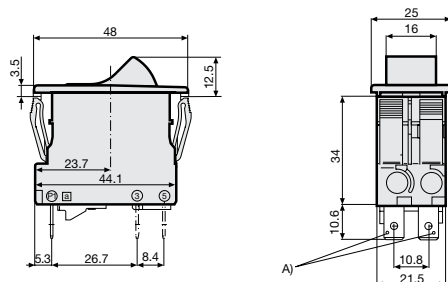

A) Quick connect terminal, IEC 61210, A6.3-0.8 mm

Screw clamp terminal

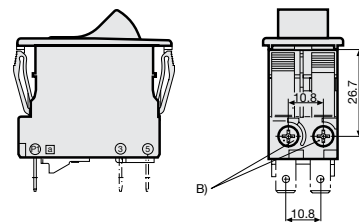

B) Screw type M3, 5x6 (Philips Form H), maximum torque 1 Nm

Accessories / factory mounted

AZM01 / Collar with cover, IP54

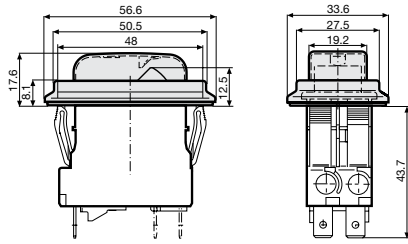

AZM02 / Raised collar with cover, narrow, IP54

AZM03 / Raised collar, IP40

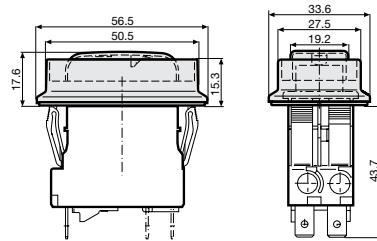

AZM10 / Collar with cover, narrow, IP54

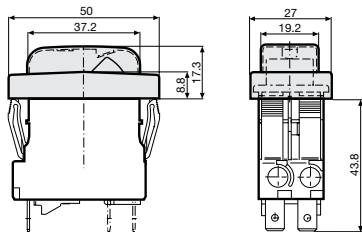

AZM11 / Partially raised collar with cover, narrow, IP54

AZM12 / Partially raised collar without cover, narrow, IP40

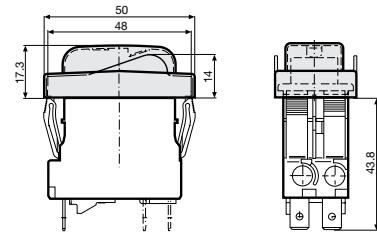

AZM13 / Raised collar narrow, IP40

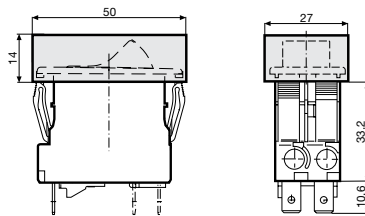

AZM14 / Raised collar with cover narrow, IP54

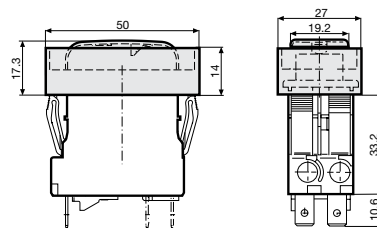

**Cut-out and pin-out**

Cut-out snap-in type

Pin-out

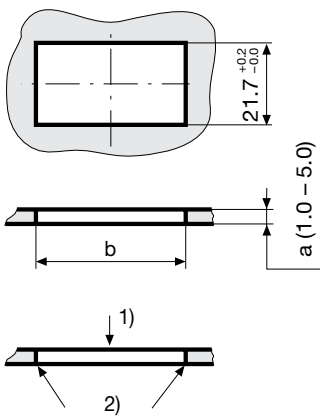

a	b
1.0	44,5...45,0
1.5	44,5...45,0
2.0	44,7...45,2
2.5	44,7...45,2
3.0	44,8...45,3
4.0	44,9...45,4
5.0	45,0...45,5

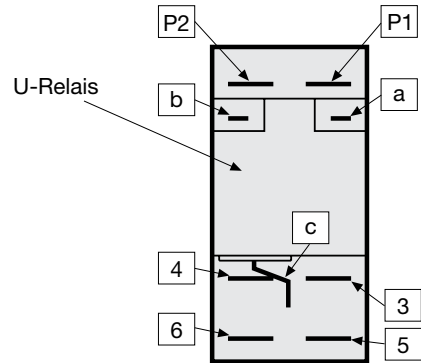

- 1) Assemble
- 2) edge must be sharp

**Diagrams**

Without thermal overload protection

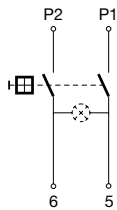

1 pole thermal overload protection

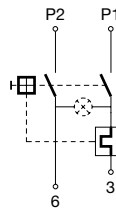

1 pole thermal overload protection, Shunt terminal

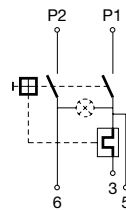

2 pole thermal overload protection

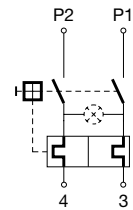

2 pole thermal overload protection, Shunt terminal

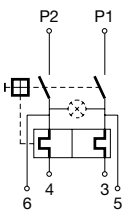

Time-Current-Curves

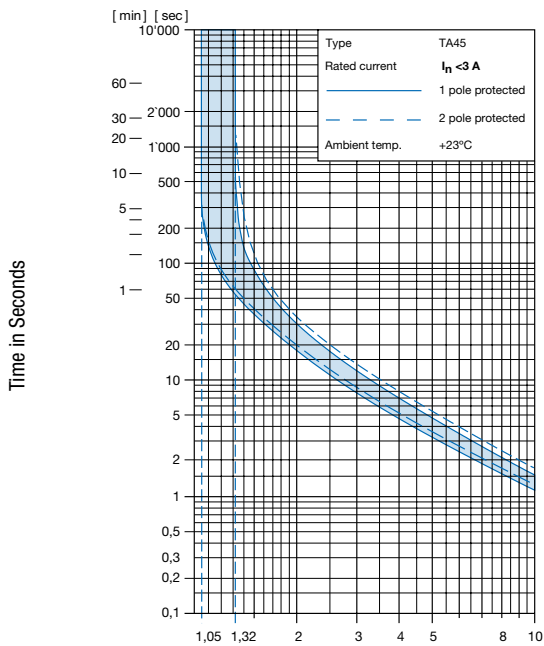

Multiple of Rated Current  $I_n$

Reference Temperature +23°

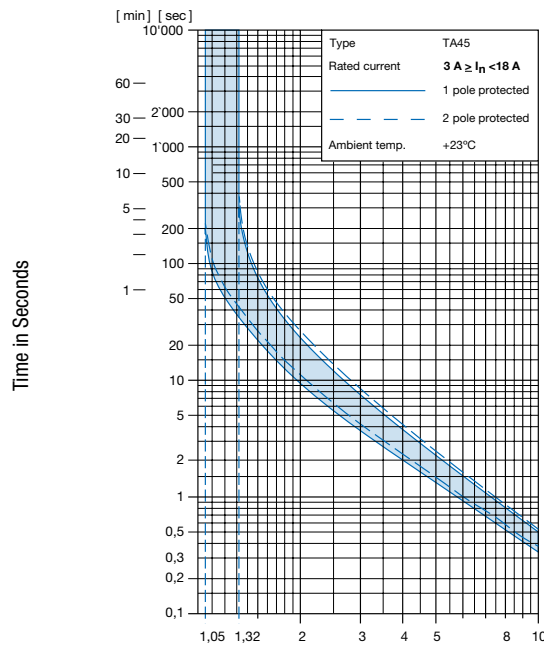

Multiple of Rated Current  $I_n$

Reference Temperature +23°

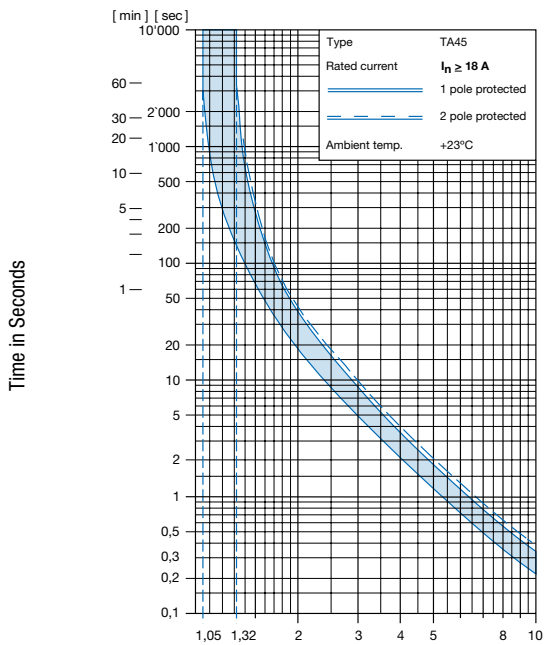

Multiple of Rated Current  $I_n$

Reference Temperature +23°

## Effect of ambient temperature

The units are calibrated for an ambient temperature of +23°C. To determine the rated current for a lower or higher ambient temperature, use a correction factor (typical value) from the table below:

Ambient temperature [°C]	Correction factor
-10	0.89
-5	0.91
0	0.92
+23	1.00
+30	1.03
+40	1.08
+55	1.16

Example: Rated current = 5 A; Environmental temperature = 40 °C; --> Correction factor = 1.08; Resulting current = 5.5 A --> Fount to next higher rated current: 6 A

## Config. Code

### TA45 - AK2 W F 120 A2 - AZM11

The characters are placeholders for the correspondingly keys of selections from the key tables.

### TA45 - AK2 W F 120 A2 - AZM11 = Basic function

Basic function	Configuration key	Basic function	Configuration key
2-pole, rocker, flat connection, illuminated 220 V...240 V	A02	2-pole, rocker, 2pole overload protection, shunt terminal, flat connection, illuminated 10 V...13 V	A48
2-pole, rocker, flat connection, illuminated 110 V...120 V	A04	2-pole, rocker, 2pole overload protection, shunt terminal, flat connection, illuminated 4 V...7 V	A49
2-pole, rocker, flat connection, illuminated 220 V...26 V	A07	2-pole, rocker, screw connection, illuminated 220 V...240 V	A52
2-pole, rocker, flat connection, illuminated 10 V...13 V	A08	2-pole, rocker, screw connection, illuminated 110 V...120 V	A54
2-pole, rocker, flat connection, illuminated 4 V...7 V	A09	2-pole, rocker, screw connection, illuminated 20 V...26 V	A57
2-pole, rocker, 1pole overload protection, flat connection, illuminated 220 V...240 V	A12	2-pole, rocker, screw connection, illuminated 10 V...13 V	A58
2-pole, rocker, 1pole overload protection, flat connection, illuminated 110 V...120 V	A14	2-pole, rocker, screw connection, illuminated 4 V...7 V	A59
2-pole, rocker, 1pole overload protection, flat connection, illuminated 20 V...26 V	A17	2-pole, rocker, 1pole overload protection, screw connection, illuminated 220 V...240 V	A62
2-pole, rocker, 1pole overload protection, flat connection, illuminated 10 V...13 V	A18	2-pole, rocker, 1pole overload protection, screw connection, illuminated 110 V...120 V	A64
2-pole, rocker, 1pole overload protection, flat connection, illuminated 4 V...7 V	A19	2-pole, rocker, 1pole overload protection, screw connection, illuminated 20 V...26 V	A67
2-pole, rocker, 1pole overload protection, shunt terminal, flat connection, illuminated 220 V...240 V	A22	2-pole, rocker, 1pole overload protection, screw connection, illuminated 10 V...13 V	A68
2-pole, rocker, 1pole overload protection, shunt terminal, flat connection, illuminated 110 V...120 V	A24	2-pole, rocker, 1pole overload protection, screw connection, illuminated 4 V...7 V	A69
2-pole, rocker, 1pole overload protection, shunt terminal, flat connection, illuminated 20 V...26 V	A27	2-pole, rocker, 1pole overload protection, shunt terminal, screw connection, illuminated 220 V...240 V	A72
2-pole, rocker, 1pole overload protection, shunt terminal, flat connection, illuminated 10 V...13 V	A28	2-pole, rocker, 1pole overload protection, shunt terminal, screw connection, illuminated 110 V...120 V	A74
2-pole, rocker, 1pole overload protection, shunt terminal, flat connection, illuminated 4 V...7 V	A29	2-pole, rocker, 1pole overload protection, shunt terminal, screw connection, illuminated 20 V...26 V	A77
2-pole, rocker, 2pole overload protection, flat connection, illuminated 220 V...240 V	A32	2-pole, rocker, 1pole overload protection, shunt terminal, screw connection, illuminated 10 V...13 V	A78
2-pole, rocker, 2pole overload protection, flat connection, illuminated 110 V...120 V	A34	2-pole, rocker, 1pole overload protection, shunt terminal, screw connection, illuminated 4 V...7 V	A79
2-pole, rocker, 2pole overload protection, flat connection, illuminated 20 V...26 V	A37	2-pole, rocker, 2pole overload protection, screw connection, illuminated 220 V...240 V	A82
2-pole, rocker, 2pole overload protection, flat connection, illuminated 10 V...13 V	A38	2-pole, rocker, 2pole overload protection, screw connection, illuminated 110 V...120 V	A84
2-pole, rocker, 2pole overload protection, flat connection, illuminated 4 V...7 V	A39	2-pole, rocker, 2pole overload protection, screw connection, illuminated 20 V...26 V	A87
2-pole, rocker, 2pole overload protection, shunt terminal, flat connection, illuminated 220 V...240 V	A42	2-pole, rocker, 2pole overload protection, screw connection, illuminated 10 V...13 V	A88
2-pole, rocker, 2pole overload protection, shunt terminal, flat connection, illuminated 110 V...120 V	A44	2-pole, rocker, 2pole overload protection, screw connection, illuminated 4 V...7 V	A89
2-pole, rocker, 2pole overload protection, shunt terminal, flat connection, illuminated 20 V...26 V	A47	2-pole, rocker, 2pole overload protection, shunt terminal, screw connection, illuminated 220 V...240 V	A92
		2-pole, rocker, 2pole overload protection, shunt terminal, screw connection, illuminated 110 V...120 V	A94

Basic function	Configuration key
2-pole, rocker, 2pole overload protection, shunt terminal, screw connection, illuminated 20 V...26 V	A97
2-pole, rocker, 2pole overload protection, shunt terminal, screw connection, illuminated 10 V...13 V	A98
2-pole, rocker, 2pole overload protection, shunt terminal, screw connection, illuminated 4 V...7 V	A99
2-pole, rocker, flat connection, without illumination	ABC
2-pole, rocker, 2pole overload protection, flat connection, without illumination	ABD
2-pole, rocker, 1pole overload protection, shunt terminal, flat connection, without illumination	ABF
2-pole, rocker, 2pole overload protection, shunt terminal, flat connection, without illumination	ABG
2-pole, rocker, 1pole overload protection, flat connection, without illumination	ABT
2-pole, rocker, flat connection, momentary switch, without illumination	AEC
2-pole, rocker, 2pole overload protection, flat connection, momentary switch, without illumination	AED
2-pole, rocker, 1pole overload protection, shunt terminal, flat connection, momentary switch, without illumination	AEF
2-pole, rocker, 2pole overload protection, shunt terminal, flat connection, momentary switch, without illumination	AEG
2-pole, rocker, 1pole overload protection, flat connection, momentary switch, without illumination	AET
2-pole, rocker, screw connection, without illumination	AHC
2-pole, rocker, 2pole overload protection, screw connection, without illumination	AHD
2-pole, rocker, 1pole overload protection, shunt terminal, screw connection, without illumination	AHF
2-pole, rocker, 2pole overload protection, shunt terminal, screw connection, without illumination	AHG
2-pole, rocker, 1pole overload protection, screw connection, without illumination	AHT
2-pole, rocker, screw connection, momentary switch, without illumination	AJC
2-pole, rocker, 2pole overload protection, screw connection, momentary switch, without illumination	AJD
2-pole, rocker, 1pole overload protection, shunt terminal, screw connection, momentary switch, without illumination	AJF
2-pole, rocker, 2pole overload protection, shunt terminal, screw connection, momentary switch, without illumination	AJG
2-pole, rocker, 1pole overload protection, screw connection, momentary switch, without illumination	AJT

TA45 - AK2 **W** F 120 A2 - AZM11 = Actuator colour

Actuator colour	Configuration key
Clear transparent	1
Red transparent	3
Green transparent	4
Orange transparent	6
Black	B
Green	G
Red	R
White	W
Orange	X
Yellow	Y

TA45 - AK2 **W** F 120 A2 - AZM11 = Legend

Legend	Configuration key
embossed	F
white printed	H
black printed	K
white printed	L
black printed	M
white printed	P
black printed	R
white printed	S
black printed	T

TA45 - AK2 **W** F 120 A2 - AZM11 = Rated current

Rated current	Configuration key
without thermal overload protection / temporarily without VDE approval	C00
0.05 A	Z05
0.1 A	J01
0.2 A	J02
0.3 A	J03
0.4 A	J04
0.5 A	J05
0.6 A	J06
0.7 A	J07
0.8 A	J08
0.9 A	J09
1.0 A	J10
1.1 A	J11
1.2 A	J12
1.3 A	J13
1.4 A	J14
1.5 A	J15
1.6 A	J16
1.7 A	J17
1.8 A	J18
1.9 A	J19
2.0 A	J20
2.1 A	J21
2.2 A	J22
2.3 A	J23
2.5 A	J25
2.8 A	J28

Other rated currents on request

Rated current	Configuration key
3.0 A	030
3.5 A	035
4.0 A	040
4.5 A	045
5.0 A	050
6.0 A	060
6.5 A	065
7.0 A	070
7.5 A	075
8.0 A	080
9.0 A	090
10.0 A	100
11.0 A	110
12.0 A	120
13.0 A	130
14.0 A	140
15.0 A	150
16.0 A	160
17.0 A	170
18.0 A	180
19.0 A	190
20.0 A	200

Other rated currents on request

TA45 - AK2 W F 120 **A2** - AZM11 = Release / lock-out latch

Release / lock-out latch	Configuration key
without release / lock-out latch	C0

TA45 - AK2 W F 120 A2 - **AZM11** = Accessories

Factory mounted accessories	Configuration key
Without cover	
Collar with cover, IP54	AZM01
Raised collar with cover, IP54	AZM02
Raised collar, IP40	AZM03
Raised collar with cover narrow, IP54	AZM10
Partially raised collar with cover, narrow, IP54	AZM11
Partially raised collar without cover, narrow, IP40	AZM12
Raised collar narrow, IP40	AZM13
Raised collar with cover narrow, IP54	AZM14

For subsequent fitting accessories see:

[http://www.schurter.ch/pdf/english/typ\\_TA45-ACC.pdf](http://www.schurter.ch/pdf/english/typ_TA45-ACC.pdf)

## Variants

Thermal overload protection	Addition	connection type	Illumination	Actuator colour	Legend	Rated current	Accessories	Config. Code	Order Number
1-pole		Quick connect terminal	without illumination	White	embossed	10.0 A	Without cover	TA45-ABTWF100C0	4430.0022
2-pole		Quick connect terminal	without illumination	Black	white printed	15.0 A	Without cover	TA45-ABDBL150C0	4430.1089
2-pole		Quick connect terminal	without illumination	Black	white printed	15.0 A	Without cover	TA45-ABDBS150C0	4430.1328

Most Popular.

Availability for all products can be searched real-time: <http://www.schurter.com/Stock-Check/Stock-Check-SCHURTER>

**Packaging Unit** 1 Pcs

## Accessories



# Mouser Electronics

Authorized Distributor

Click to View Pricing, Inventory, Delivery & Lifecycle Information:

## Schurter:

<a href="#"><u>4430.0005</u></a>	<a href="#"><u>4430.0012</u></a>	<a href="#"><u>4430.0015</u></a>	<a href="#"><u>4430.0022</u></a>	<a href="#"><u>4430.0024</u></a>	<a href="#"><u>4430.0031</u></a>	<a href="#"><u>4430.0038</u></a>	<a href="#"><u>4430.0385</u></a>	<a href="#"><u>4430.0413</u></a>	<a href="#"><u>4430.0423</u></a>
<a href="#"><u>4430.0428</u></a>	<a href="#"><u>4430.0429</u></a>	<a href="#"><u>4430.0431</u></a>	<a href="#"><u>4430.0444</u></a>	<a href="#"><u>4430.0469</u></a>	<a href="#"><u>4430.0542</u></a>	<a href="#"><u>4430.0543</u></a>	<a href="#"><u>4430.0545</u></a>	<a href="#"><u>4430.0559</u></a>	<a href="#"><u>4430.0561</u></a>
<a href="#"><u>4430.0572</u></a>	<a href="#"><u>4430.0573</u></a>	<a href="#"><u>4430.0586</u></a>	<a href="#"><u>4430.0646</u></a>	<a href="#"><u>4430.0665</u></a>	<a href="#"><u>4430.0681</u></a>	<a href="#"><u>4430.0683</u></a>	<a href="#"><u>4430.0684</u></a>	<a href="#"><u>4430.0699</u></a>	<a href="#"><u>4430.0703</u></a>
<a href="#"><u>4430.0704</u></a>	<a href="#"><u>4430.0705</u></a>	<a href="#"><u>4430.0706</u></a>	<a href="#"><u>4430.0707</u></a>	<a href="#"><u>4430.0708</u></a>	<a href="#"><u>4430.0709</u></a>	<a href="#"><u>4430.0764</u></a>	<a href="#"><u>4430.0765</u></a>	<a href="#"><u>4430.0777</u></a>	<a href="#"><u>4430.0778</u></a>
<a href="#"><u>4430.0847</u></a>	<a href="#"><u>4430.0861</u></a>	<a href="#"><u>4430.0881</u></a>	<a href="#"><u>4430.0884</u></a>	<a href="#"><u>4430.0885</u></a>	<a href="#"><u>4430.0892</u></a>	<a href="#"><u>4430.0904</u></a>	<a href="#"><u>4430.0907</u></a>	<a href="#"><u>4430.0924</u></a>	<a href="#"><u>4430.0963</u></a>
<a href="#"><u>4430.0977</u></a>	<a href="#"><u>4430.0982</u></a>	<a href="#"><u>4430.0988</u></a>	<a href="#"><u>4430.0991</u></a>	<a href="#"><u>4430.1034</u></a>	<a href="#"><u>4430.1037</u></a>	<a href="#"><u>4430.1038</u></a>	<a href="#"><u>4430.1067</u></a>	<a href="#"><u>4430.1068</u></a>	<a href="#"><u>4430.1077</u></a>
<a href="#"><u>4430.1096</u></a>	<a href="#"><u>4430.1129</u></a>	<a href="#"><u>4430.1133</u></a>	<a href="#"><u>4430.1143</u></a>	<a href="#"><u>4430.1144</u></a>	<a href="#"><u>4430.1146</u></a>	<a href="#"><u>4430.1147</u></a>	<a href="#"><u>4430.1158</u></a>	<a href="#"><u>4430.1203</u></a>	<a href="#"><u>4430.1219</u></a>
<a href="#"><u>4430.1231</u></a>	<a href="#"><u>4430.1232</u></a>	<a href="#"><u>4430.1248</u></a>	<a href="#"><u>4430.1251</u></a>	<a href="#"><u>4430.1273</u></a>	<a href="#"><u>4430.1274</u></a>	<a href="#"><u>4430.1275</u></a>	<a href="#"><u>4430.1293</u></a>	<a href="#"><u>4430.1294</u></a>	<a href="#"><u>4430.1296</u></a>
<a href="#"><u>4430.1328</u></a>	<a href="#"><u>4430.1351</u></a>	<a href="#"><u>4430.1359</u></a>	<a href="#"><u>4430.1365</u></a>	<a href="#"><u>4430.1366</u></a>	<a href="#"><u>4430.1384</u></a>	<a href="#"><u>4430.1393</u></a>	<a href="#"><u>4430.1402</u></a>	<a href="#"><u>4430.1403</u></a>	<a href="#"><u>4430.1406</u></a>
<a href="#"><u>4430.1427</u></a>	<a href="#"><u>4430.1447</u></a>	<a href="#"><u>4430.1472</u></a>	<a href="#"><u>4430.1474</u></a>	<a href="#"><u>4430.1475</u></a>	<a href="#"><u>4430.1477</u></a>	<a href="#"><u>4430.1486</u></a>	<a href="#"><u>4430.1536</u></a>	<a href="#"><u>4430.1563</u></a>	<a href="#"><u>4430.1605</u></a>