

Surface Mount RF Schottky Barrier Diodes

Technical Data

HSMS-28XX Series

Features

- Surface Mount SOT-23/SOT-143 Package
- Low Turn-On Voltage (As Low as 0.34 V at 1 mA)
- Low FIT (Failure in Time) Rate*
- Six-sigma Quality Level
- Single, Dual and Quad Versions
- Tape and Reel Options Available

* For more information see the Surface Mount Schottky Reliability Data Sheet.

Description/Applications

These Schottky diodes are specifically designed for both analog and digital applications. This series offers a wide range of specifications and package configurations to give the designer wide flexibility. Typical applications of these Schottky diodes are mixing, detecting, switching, sampling, clamping, and wave shaping. The HSMS-2800 series of diodes is optimized for high voltage applications. The HSMS-2810 series of diodes features very low flicker (1/f) noise. The

Package Lead Code Identification

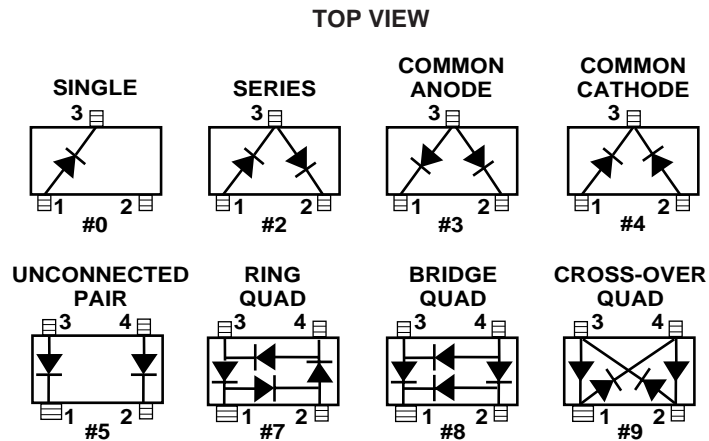

HSMS-2820 series of diodes is the best all-around choice for most applications, featuring low series resistance, low forward voltage at all current levels and good RF characteristics. The HSMS-2860 series is a high performance diode offering superior V_f and ultra-low capacitance.

Note that HP's manufacturing techniques assure that dice found in pairs and quads are taken from adjacent sites on the wafer, assuring the highest degree of match.

Electrical Specifications $T_A = 25^\circ\text{C}$, Single Diode^[4]

Part Number HSMS ^[5]	Package Marking Code ^[3]	Lead Code	Configuration	Nearest Equivalent Axial Lead Part No. 5082-	Minimum Break-down Voltage V_{BR} (V)	Maximum Forward Voltage V_F (mV)	Maximum Forward Voltage V_F (V) @ I_F (mA)	Maximum Reverse Leakage I_R (nA) @ V_R (V)	Maximum Capacitance C_T (pF)	Typical Dynamic Resistance R_D (Ω) ^[6]
2800	A0	0	Single	2800 (1N5711)	70	400	1.0 15	200 50	2.0	35
2802	A2	2	Series							
2803	A3	3	Common Anode							
2804	A4	4	Common Cathode							
2805	A5	5	Unconnected Pair							
2807	A7	7	Ring Quad ^[6]							
2808	A8	8	Bridge Quad ^[6]							
2810	B0	0	Single							
2812	B2	2	Series							
2813	B3	3	Common Anode							
2814	B4	4	Common Cathode							
2815	B5	5	Unconnected Pair							
2817	B7	7	Ring Quad ^[6]							
2818	B8	8	Bridge Quad ^[6]							
2820	C0	0	Single	2835	15*	340	0.7 30	100 1	1.0	12
2822	C2	2	Series							
2823	C3	3	Common Anode							
2824	C4	4	Common Cathode							
2825	C5	5	Unconnected Pair							
2827	C7	7	Ring Quad ^[6]							
2828	C8	8	Bridge Quad ^[6]							
2829	C9	9	Cross-over Quad							
2860	T0	0	Single	None	4	350	0.6 30	—	0.35	10
2862	T1	2	Series Pair							
2863	T3	3	Common Anode							
2864	T4	4	Common Cathode							
2865	T5	5	Unconnected Pair							
Test Conditions										

Notes:

- ΔV_F for diodes in pairs and quads in 15 mV maximum at 1 mA.
- ΔC_{T0} for diodes in pairs and quads is 0.2 pF maximum.
- Package marking code is in white.
- Effective Carrier Lifetime (τ) for all these diodes is 100 ps maximum measured with Krakauer method at 5 mA, except HSMS-282X which is measured at 20 mA.
- See section titled "Quad Capacitance."
- $R_D = R_S + 5.2 \Omega$ at 25°C and $I_f = 5 \text{ mA}$.

Absolute Maximum Ratings^[1] $T_A = 25^\circ\text{C}$

Symbol	Parameter	Value
I_f	Forward Current (1 ms Pulse)	1 Amp
P_t	Total Device Dissipation	250 mW ^[2]
P_{IV}	Peak Inverse Voltage	Same as V_{BR}
T_j	Junction Temperature	150°C
T_{stg}	Storage Temperature	-65 to 150°C

Notes:

1. Operation in excess of any one of these conditions may result in permanent damage to this device.
2. CW Power Dissipation at $T_{LEAD} = 25^\circ\text{C}$. Derate to zero at maximum rated temperature.

Quad Capacitance

Capacitance of Schottky diode quads is measured using an HP4271 LCR meter. This instrument effectively isolates individual diode branches from the others, allowing accurate capacitance measurement of each branch or each diode. The conditions are: 20 mV R.M.S. voltage at 1 MHz. HP defines this measurement as "CM", and it is equivalent to the capacitance of the diode by itself. The equivalent diagonal and adjacent capacitances can then be calculated by the formulas given below.

In a quad, the diagonal capacitance is the capacitance between points A and B as shown in the figure below. The diagonal capacitance is calculated using the following formula

$$C_{\text{DIAGONAL}} = \frac{C_1 \times C_2}{C_1 + C_2} + \frac{C_3 \times C_4}{C_3 + C_4}$$

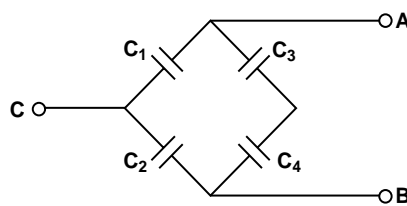

The equivalent adjacent capacitance is the capacitance between points A and C in the figure below. This capacitance is calculated using the following formula

$$C_{\text{ADJACENT}} = C_1 + \frac{1}{\frac{1}{C_2} + \frac{1}{C_3} + \frac{1}{C_4}}$$

This information does not apply to cross-over quad diodes.

SPICE Parameters

Parameter	Units	HSMS-280X	HSMS-281X	HSMS-282X	HSMS-286X
B_V	V	75	25	15	7.0
C_{J0}	pF	1.6	1.1	0.7	0.18
E_G	eV	0.69	0.69	0.69	0.69
I_{BV}	A	10E-5	10E-5	10E-4	10E-5
I_S	A	3x10E-8	4.8x10E-9	2.2x10E-8	5.0x10E-8
N		1.08	1.08	1.08	1.08
R_S	Ω	30	10	6.0	5.0
P_B	V	0.65	0.65	0.65	0.65
P_T		2	2	2	2
M		0.5	0.5	0.5	0.5

Typical Parameters at $T_A = 25^\circ\text{C}$ (unless otherwise noted), Single Diode

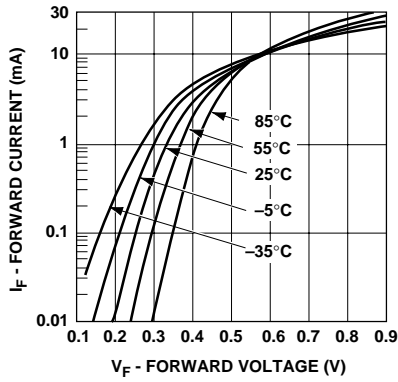

Figure 1. Typical Forward Current vs. Forward Voltage at Temperatures—HSMS-2800 Series

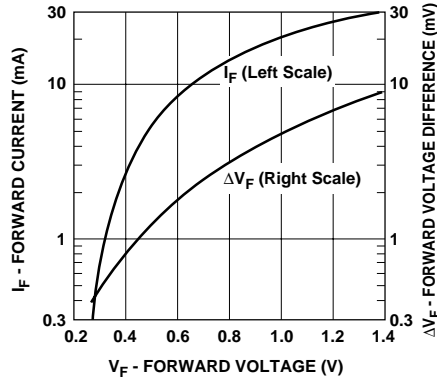

Figure 2. Typical V_f Match, HSMS-2800 Series Pairs and Quads.

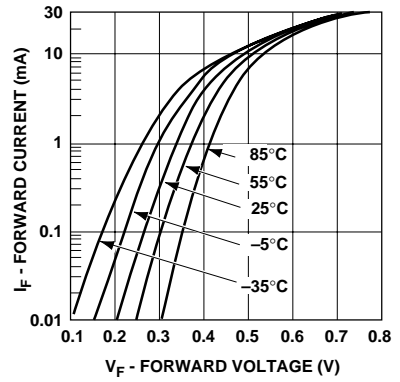

Figure 3. Typical Forward Current vs. Forward Voltage at Temperatures—HSMS-2810 Series.

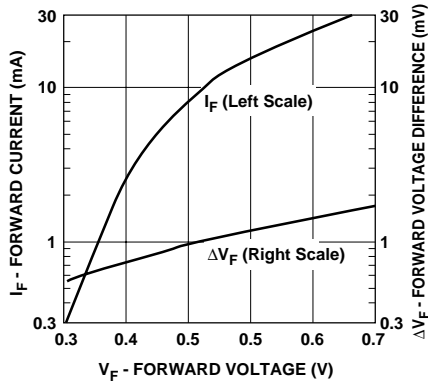

Figure 4. Typical V_f Match, HSMS-2810 Series Pairs and Quads.

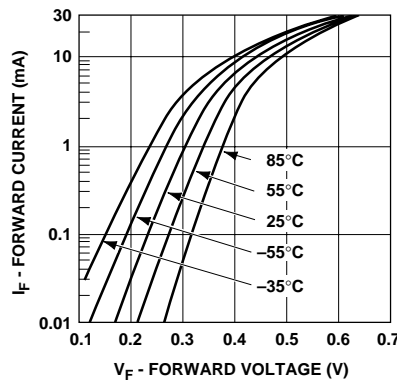

Figure 5. Typical Forward Current vs. Forward Voltage At Temperatures—HSMS-2820 Series.

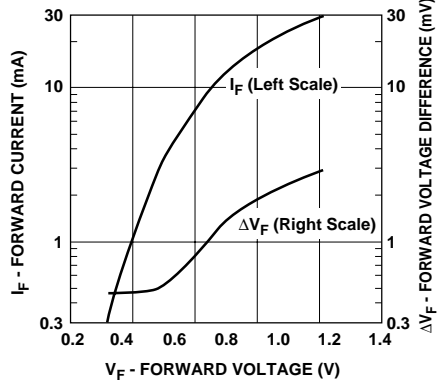

Figure 6. Typical V_f Match, HSMS-2820 Series Pairs and Quads at Mixer Bias Levels.

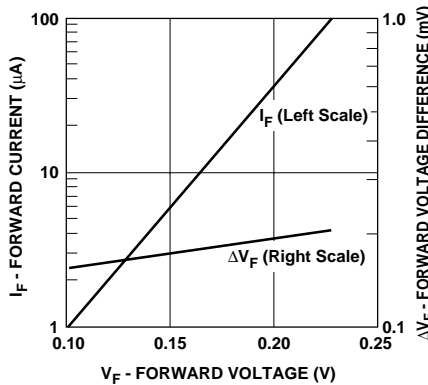

Figure 7. Typical V_f Match, HSMS-2820 Series Pairs at Detector Bias Levels.

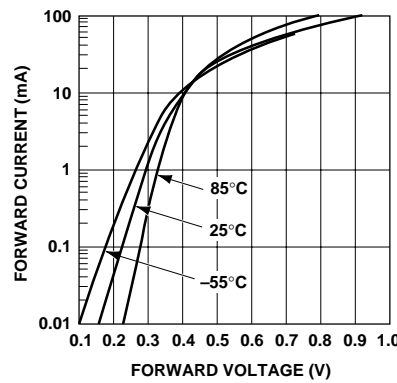

Figure 8. Typical Forward Current vs. Forward Voltage at Temperature, HSMS-2860 Series.

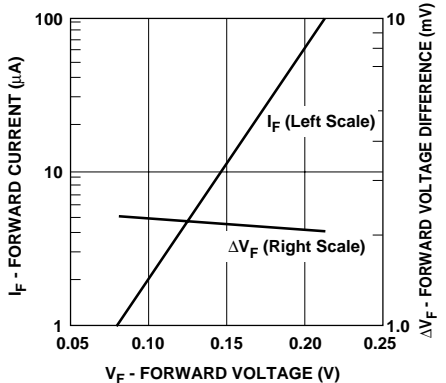

Figure 9. Typical V_f Match, HSMS-2860 Series Pairs at Detector Bias Levels.

Typical Parameters, continued

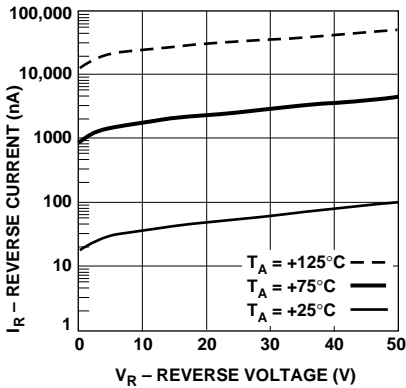

Figure 10. Reverse Current vs. Reverse Voltage at Temperatures—HSMS-2800 Series.

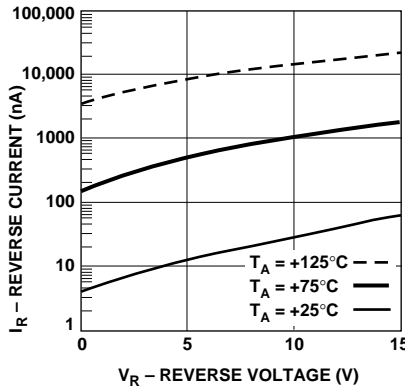

Figure 11. Reverse Current vs. Reverse Voltage at Temperatures—HSMS-2810 Series.

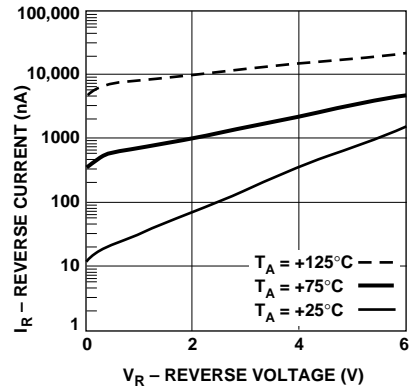

Figure 12. Reverse Current vs. Reverse Voltage at Temperatures—HSMS-2820 Series.

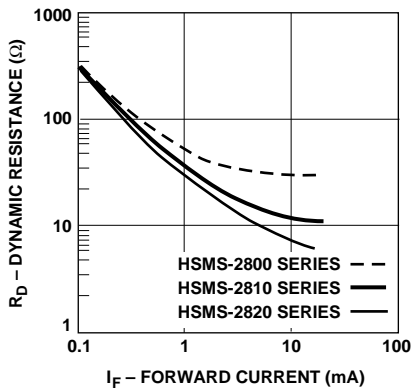

Figure 13. Dynamic Resistance vs. Forward Current—HSMS-2800 Series.

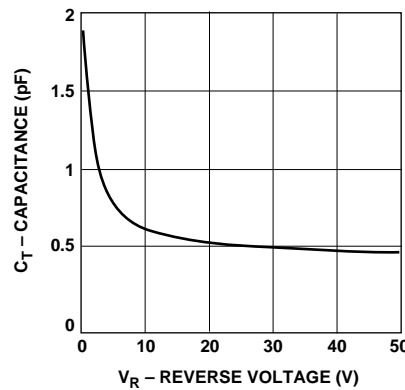

Figure 14. Total Capacitance vs. Reverse Voltage—HSMS-2800 Series.

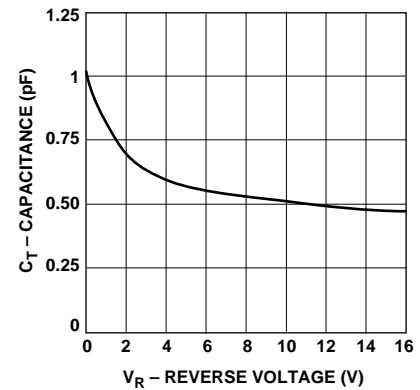

Figure 15. Total Capacitance vs. Reverse Voltage—HSMS-2810 Series.

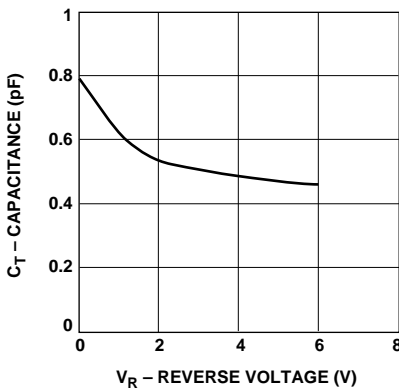

Figure 16. Total Capacitance vs. Reverse Voltage—HSMS-2820 Series.

Profile Option Descriptions

- BLK = Bulk
- TR1 = 3K pc. Tape and Reel, Device Orientation; See Figures 17 and 18
- TR2 = 10K pc. Tape and Reel, Device Orientation; See Figures 17 and 18

Tape and Reeling conforms to Electronic Industries RS-481, "Taping of Surface Mounted Components for Automated Placement."

Ordering Information

Specify part number followed by option under. For example:

H SMS - 28XX - XXX

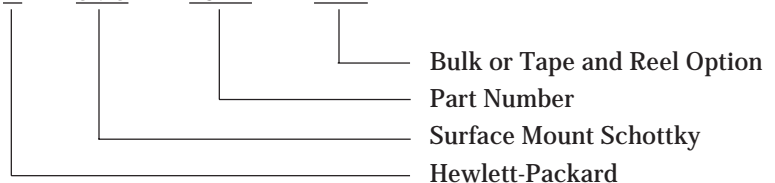

Applications Information
Schottky Diode Fundamentals
 See the HSMS-280A series data sheet.

Package Characteristics

Lead Material Alloy 42
 Lead Finish Tin-Lead 85/15%
 Max. Soldering Temperature 260°C for 5 sec
 Min. Lead Strength 2 pounds pull
 Typical Package Inductance 2 nH (opposite leads)
 Typical Package Capacitance 0.08 pF (opposite leads)

Package Dimensions Outline 23 (SOT-23)

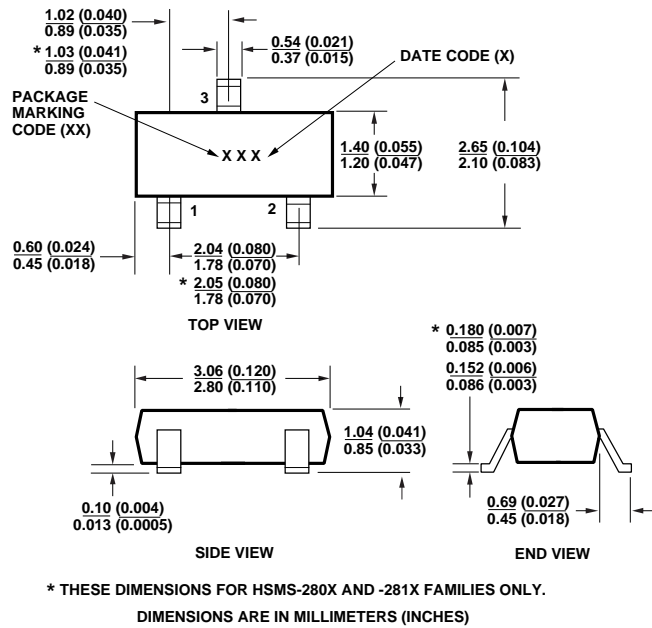

Outline 143 (SOT-143)

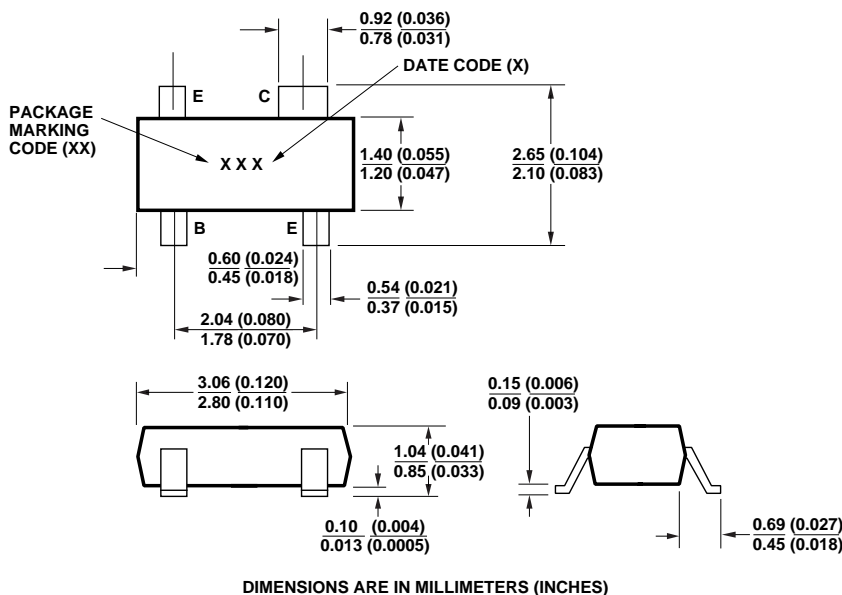

Device Orientation

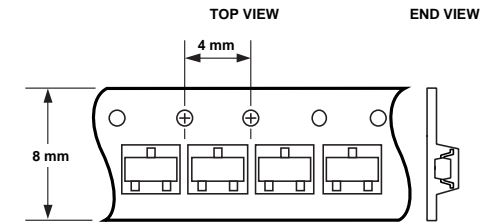
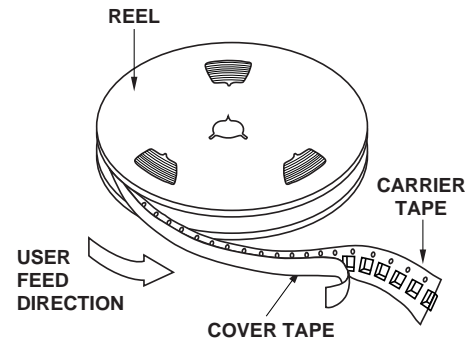

Figure 17. Options -TR1, -TR2 for SOT-23 Packages.

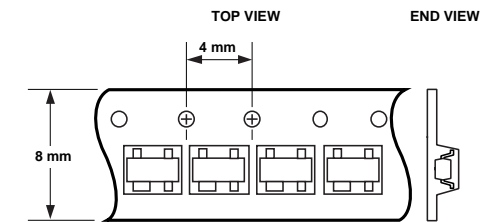

Figure 18. Options -TR1, -TR2 for SOT-143 Packages.

www.hp.com/go/rf

For technical assistance or the location of your nearest Hewlett-Packard sales office, distributor or representative call:

Americas/Canada: 1-800-235-0312 or 408-654-8675

Far East/Australasia: Call your local HP sales office.

Japan: (81 3) 3335-8152

Europe: Call your local HP sales office.

Data subject to change.
 Copyright © 1999 Hewlett-Packard Co.

Obsoletes 5968-3887E

5968-5934E (6/99)