

Spezifikation für Freigabe / specification for release

Kunde / customer : _____
 Artikelnummer / part number : **74459222**
 Bezeichnung : **SPEICHERDROSSEL WE-PD 3**
 description : **POWER-CHOKE WE-PD 3**



DATUM / DATE : 2004-02-26

A Mechanische Abmessungen / dimensions:

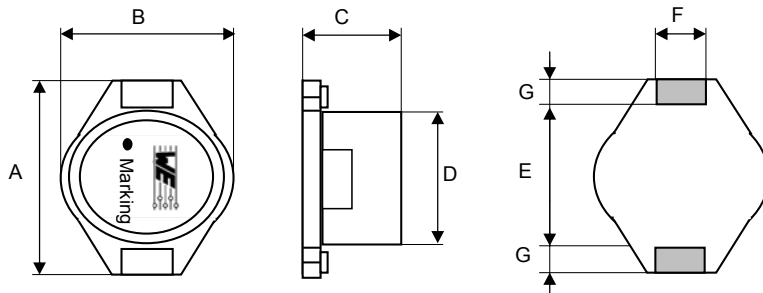

Typ X		
A	18,54 max.	mm
B	15,24 max.	mm
C	7,62 max.	mm
D	12,7 ± 0,3	mm
E	12,7 ± 0,3	mm
F	2,54 ref.	mm
G	2,54 ref.	mm

● = Start of winding Marking = Inductance code

B Elektrische Eigenschaften / electrical properties :

Eigenschaften / properties	Testbedingungen / test conditions		Wert / value	Einheit / unit	tol.
Induktivität / inductance	100 kHz / 0,1V	L	220,0	μH	± 20%
DC-Widerstand / DC-resistance	@ 20°C	R _{DC typ}	0,311	Ω	typ.
DC-Widerstand / DC-resistance	@ 20°C	R _{DC max}	0,470	Ω	max.
Nennstrom / rated current	ΔT= 40 K	I _{DC}	1,20	A	max.
Sättigungsstrom / saturation current	ΔL/L < 20%	I _{sat}	1,90	A	typ.
Eigenres.-Frequenz / self-res.-frequency		SRF	5,0	MHz	typ.

C Lötpad / soldering spec.:

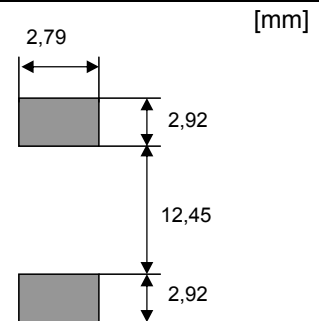

D Prüfgeräte / test equipment:

HP 4274 A für/for L und/and Q
HP 34401 A für/for I_{DC} und/and R_{DC}

E Testbedingungen / test conditions:

Luftfeuchtigkeit / humidity: 33%
 Umgebungstemperatur / temperature: +20°C

F Werkstoffe & Zulassungen / material & approvals:

Basismaterial / base material: Ferrit/ ferrite
 Draht / wire: 2 UEW 130°C
 Kontaktmaterial/ contact plating: Cu-tinned
 Sockel/ base: UL94V-0

G Eigenschaften / general specifications:

Betriebstemp. / operating temperature: -40°C - + 125°C
 Umgebungstemp. / ambient temperature: -40°C - + 85°C
 It is recommended that the temperature of the part does not exceed 125°C under worst case operating conditions.

Freigabe erteilt / general release:	Kunde / customer		
Datum / date	Unterschrift / signature		
	Würth Elektronik		
Geprüft / checked	Kontrolliert / approved		
	Name	Änderung / modification	Datum / date

Würth Elektronik eiSos GmbH & Co. KG

D-74638 Waldenburg · Max-Eyth-Strasse 1 · Germany · Telefon (+49) (0) 7942 - 945 - 0 · Telefax (+49) (0) 7942 - 945 - 400
<http://www.we-online.de>

Spezifikation für Freigabe / specification for release

Kunde / customer : _____
 Artikelnummer / part number : **74459222**
 Bezeichnung : **SPEICHERDROSSEL WE-PD 3**
 description : **POWER-CHOKE WE-PD 3**



DATUM / DATE : 2004-02-26

H Induktivitätskurve / Inductance curve :

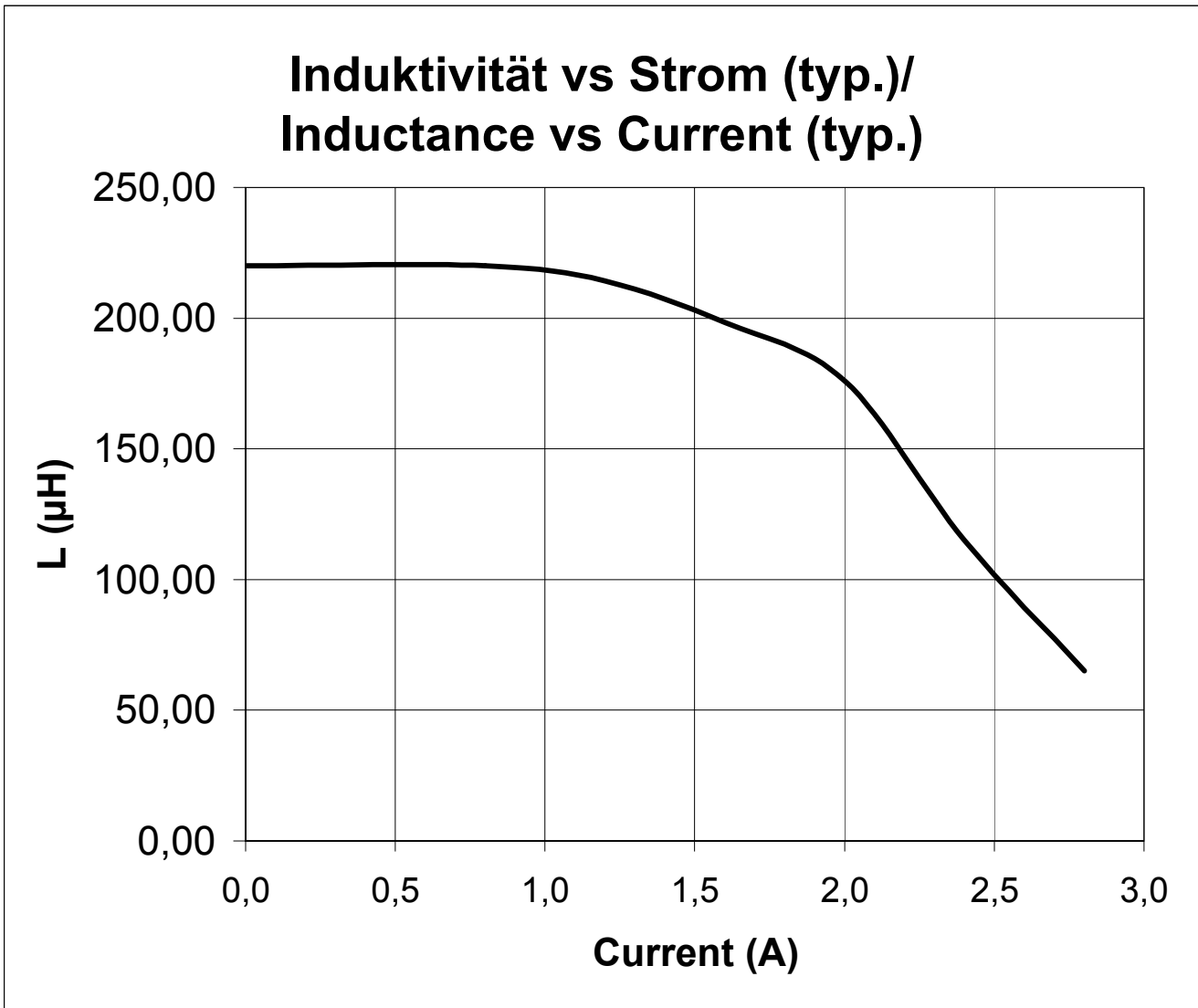

Freigabe erteilt / general release:	Kunde / customer			
.....			
Datum / date	Unterschrift / signature	MST/SST	Version 4	04-02-26
.....	RT	Version 3	03-02-25
	Würth Elektronik	AG	Version 2	02-10-30
.....	JH	Version 1	00-12-06
Geprüft / checked	Kontrolliert / approved	Name	Änderung / modification	Datum / date

Würth Elektronik eiSos GmbH & Co. KG

D-74638 Waldenburg · Max-Eyth-Strasse 1 · Germany · Telefon (+49) (0) 7942 - 945 - 0 · Telefax (+49) (0) 7942 - 945 - 400
<http://www.we-online.de>

Spezifikation für Freigabe / specification for release

Kunde / customer : _____
 Artikelnummer / part number : **74459222**
 Bezeichnung : **SPEICHERDROSSEL WE-PD 3**
 description : **POWER-CHOKE WE-PD 3**



DATUM / DATE : 2004-02-26

I Rollenspezifikation / tape and reel specification:

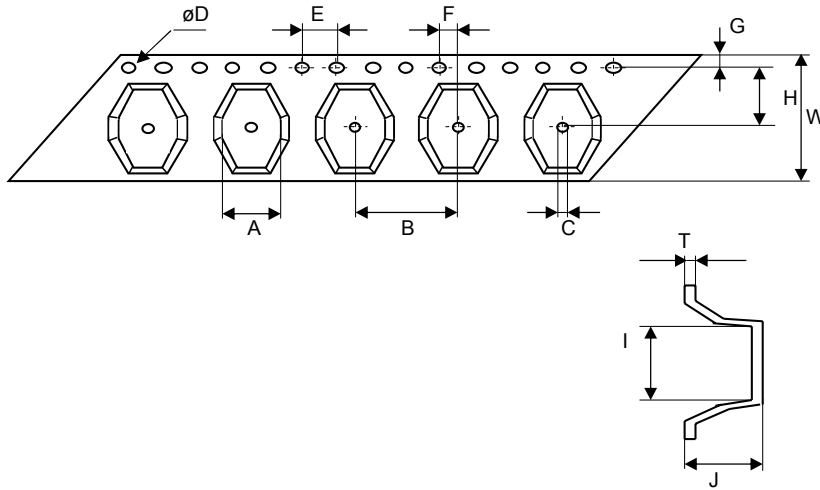

Gurtspezifikation / Tape specification:

A	14,64 ± 0,1	mm
B	24,0 ± 0,1	mm
C	2,00 min.	mm
D	1,50 ± 0,1	mm
E	4,00 ± 0,1	mm
F	2,00 ± 0,1	mm
G	1,75 ± 0,1	mm
H	14,2 ± 0,1	mm
I	18,76 ± 0,1	mm
J	7,40 ± 0,1	mm
T	0,40 ± 0,03	mm
W	32,0 ± 0,3	mm

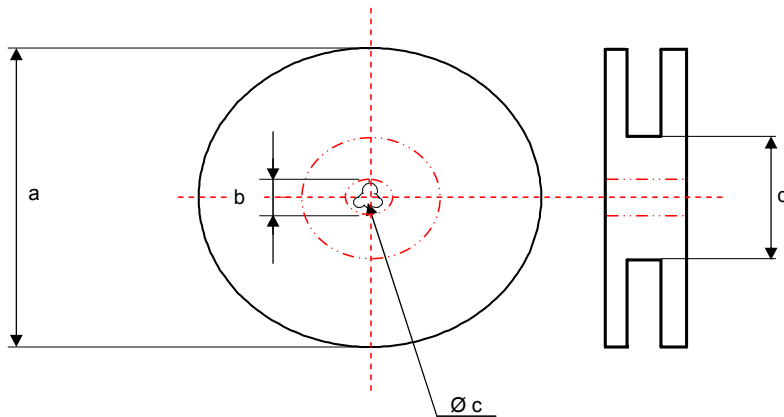

Rollenspezifikation / Reel specification:

a	330,0 ± 0,5	mm
b	20,20 ± 0,1	mm
c	13,00 +0,5 -1,0	mm
d	100,0 ± 1,0	mm

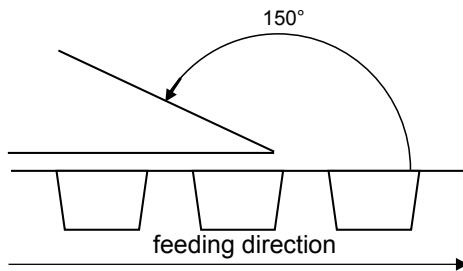

The force for tearing off cover tape is 20 to 70 grams in arrow direction

Freigabe erteilt / general release:	Kunde / customer			
Datum / date	Unterschrift / signature	MST/SST	Version 4	04-02-26
	Würth Elektronik	RT	Version 3	03-02-25
		AG	Version 2	02-10-30
		JH	Version 1	00-12-06
Geprüft / checked	Kontrolliert / approved	Name	Änderung / modification	Datum / date

Würth Elektronik eiSos GmbH & Co. KG

D-74638 Waldenburg · Max-Eyth-Strasse 1 · Germany · Telefon (+49) (0) 7942 - 945 - 0 · Telefax (+49) (0) 7942 - 945 - 400
<http://www.we-online.de>