

SN74S1053

16-BIT SCHOTTKY BARRIER DIODE BUS-TERMINATION ARRAY

SDLS017A – SEPTEMBER 1990 – REVISED AUGUST 1997

- Designed to Reduce Reflection Noise
- Repetitive Peak Forward Current to 200 mA
- 16-Bit Array Structure Suited for Bus-Oriented Systems
- Package Options Include Plastic Small-Outline Packages and Standard Plastic 300-mil DIPs

DW OR N PACKAGE
(TOP VIEW)

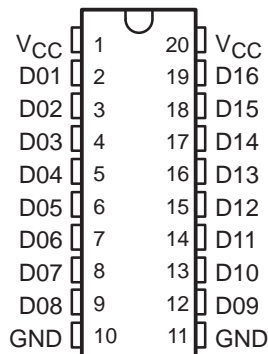

description

This Schottky barrier diode bus-termination array is designed to reduce reflection noise on memory bus lines. This device consists of a 16-bit high-speed Schottky diode array suitable for clamping to V_{CC} and/or GND.

The SN74S1053 is characterized for operation from 0°C to 70°C.

schematic diagrams

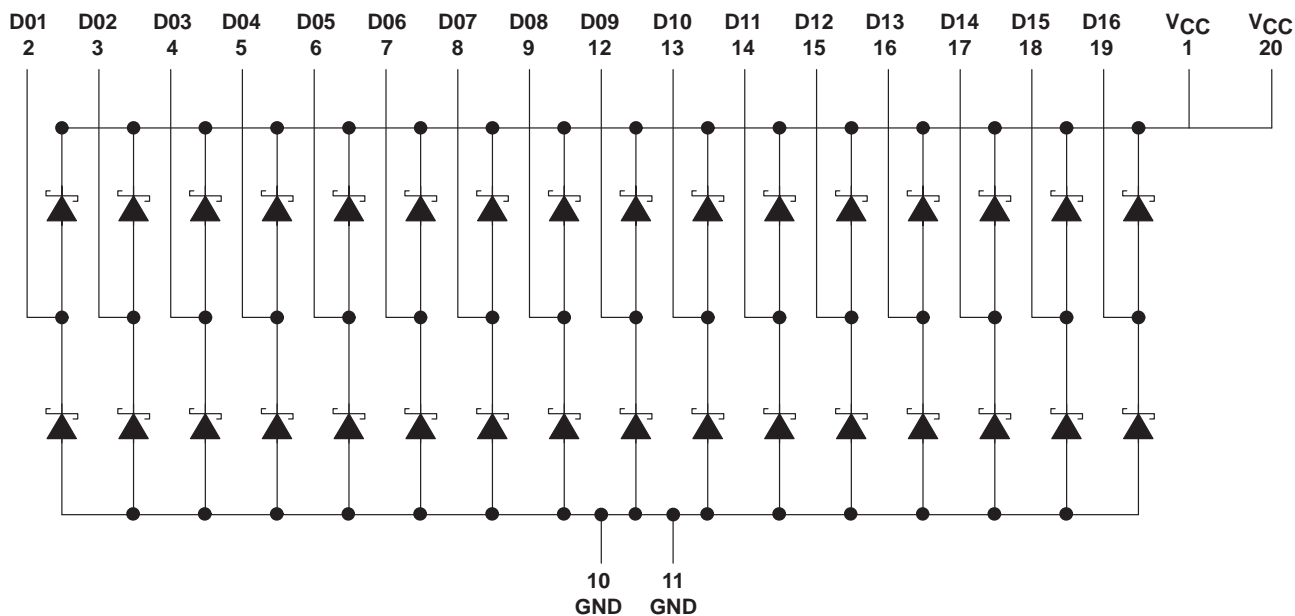

Please be aware that an important notice concerning availability, standard warranty, and use in critical applications of Texas Instruments semiconductor products and disclaimers thereto appears at the end of this data sheet.

PRODUCTION DATA information is current as of publication date. Products conform to specifications per the terms of Texas Instruments standard warranty. Production processing does not necessarily include testing of all parameters.

**TEXAS
INSTRUMENTS**

POST OFFICE BOX 655303 • DALLAS, TEXAS 75265

Copyright © 1997, Texas Instruments Incorporated

SN74S1053
16-BIT SCHOTTKY BARRIER DIODE
BUS-TERMINATION ARRAY

SDLS017A – SEPTEMBER 1990 – REVISED AUGUST 1997

absolute maximum ratings over operating free-air temperature range (unless otherwise noted)†

Steady-state reverse voltage, V_R	7 V
Continuous forward current, I_F : Any D terminal from GND or to V_{CC}	50 mA
Total through all GND or V_{CC} terminals	170 mA
Repetitive peak forward current‡, I_{FRM} : Any D terminal from GND or V_{CC}	200 mA
Total through all GND or V_{CC} terminals	1.2 A
Continuous total power dissipation at (or below) 25°C free-air temperature (see Note 1)	625 mW
Operating free-air temperature range	0°C to 70°C
Storage temperature range, T_{stg}	-65°C to 150°C

† Stresses beyond those listed under “absolute maximum ratings” may cause permanent damage to the device. These are stress ratings only, and functional operation of the device at these or any other conditions beyond those indicated under “recommended operating conditions” is not implied. Exposure to absolute-maximum-rated conditions for extended periods may affect device reliability.

‡ These values apply for $t_w \leq 100 \mu s$, duty cycle $\leq 20\%$.

NOTE 1: For operation above 25°C free-air temperature, derate linearly at the rate of 5 mW/°C.

electrical characteristics over recommended operating free-air temperature range (unless otherwise noted)

single-diode operation (see Note 2)

PARAMETER		TEST CONDITIONS		MIN	TYP§	MAX	UNIT
V_F	Static forward voltage	To V_{CC}	$I_F = 18 \text{ mA}$	0.85	1.05	V	
			$I_F = 50 \text{ mA}$	1.05	1.3		
		From GND	$I_F = 18 \text{ mA}$	0.75	0.95		
			$I_F = 50 \text{ mA}$	0.95	1.2		
V_{FM}	Peak forward voltage		$I_F = 200 \text{ mA}$	1.45		V	
I_R	Static reverse current	To V_{CC}	$V_R = 7 \text{ V}$			5	μA
		From GND			5		
C_t	Total capacitance	$V_R = 0 \text{ V}, f = 1 \text{ MHz}$		8	16	pF	
		$V_R = 2 \text{ V}, f = 1 \text{ MHz}$		4	8		

§ All typical values are at $V_{CC} = 5 \text{ V}, T_A = 25^\circ C$.

NOTE 2: Test conditions and limits apply separately to each of the diodes. The diodes not under test are open-circuited during the measurement of these characteristics.

multiple-diode operation

PARAMETER		TEST CONDITIONS		MIN	TYP‡	MAX	UNIT
I_x	Internal crosstalk current	Total I_F current = 1 A,	See Note 3	0.8	2	mA	
		Total I_F current = 198 mA,	See Note 3	0.02	0.2		

§ All typical values are at $V_{CC} = 5 \text{ V}, T_A = 25^\circ C$.

NOTE 3: I_x is measured under the following conditions with one diode static, and all others switching:

Switching diodes: $t_w = 100 \mu s$, duty cycle = 20%

Static diode: $V_R = 5 \text{ V}$

The static diode input current is the internal crosstalk current I_x .

switching characteristics, $T_A = 25^\circ C$ (see Figures 1 and 2)

PARAMETER		TEST CONDITIONS				MIN	TYP	MAX	UNIT
t_{rr}	Reverse recovery time	$I_F = 10 \text{ mA}, I_{RM(REC)} = 10 \text{ mA}, I_{R(REC)} = 1 \text{ mA}, R_L = 100 \Omega$				8	16	ns	



PARAMETER MEASUREMENT INFORMATION

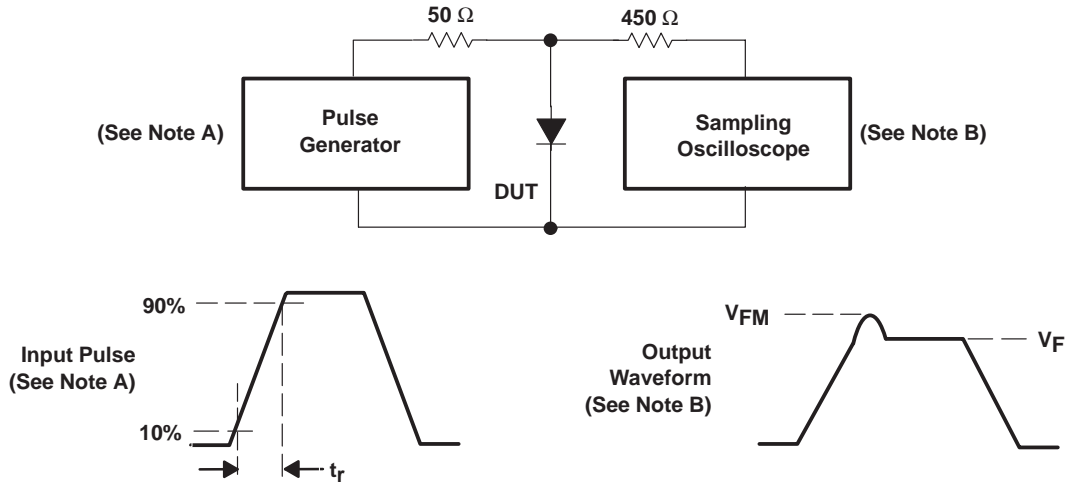

- NOTES: A. The input pulse is supplied by a pulse generator having the following characteristics: $t_r = 20$ ns, $Z_O = 50$ Ω , freq = 500 Hz, duty cycle = 1%.
 B. The output waveform is monitored by an oscilloscope having the following characteristics: $t_r \leq 350$ ps, $R_i = 50$ Ω , $C_i \leq 5$ pF.

Figure 1. Forward Recovery Voltage

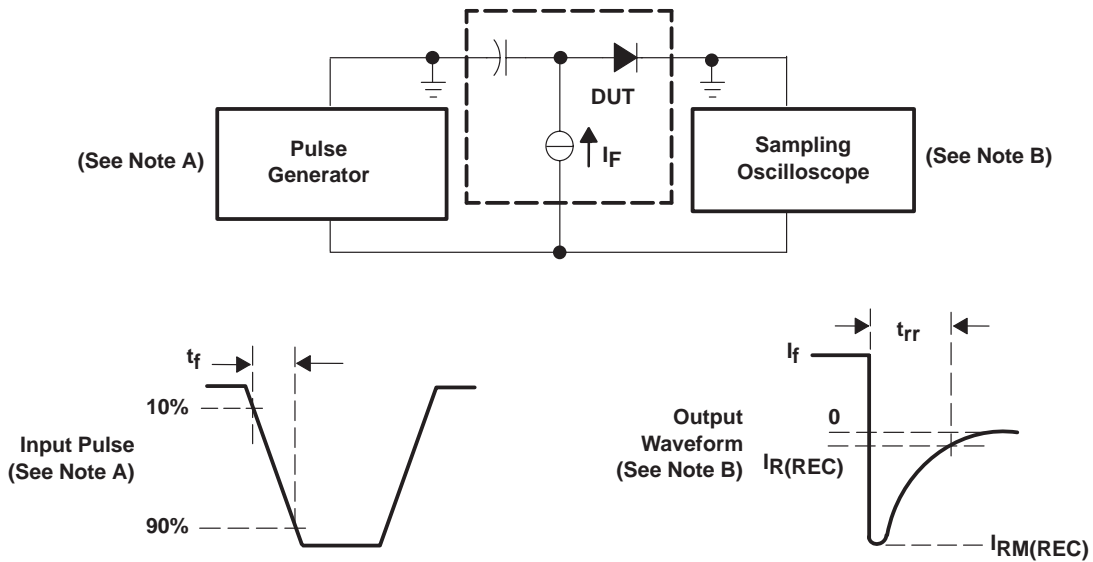

- NOTES: A. The input pulse is supplied by a pulse generator having the following characteristics: $t_f = 0.5$ ns, $Z_O = 50$ Ω , $t_w \geq 50$ ns, duty cycle = 1%.
 B. The output waveform is monitored by an oscilloscope having the following characteristics: $t_r \leq 350$ ps, $R_i = 50$ Ω , $C_i \leq 5$ pF.

Figure 2. Reverse Recovery Time

SN74S1053 16-BIT SCHOTTKY BARRIER DIODE BUS-TERMINATION ARRAY

SDLS017A – SEPTEMBER 1990 – REVISED AUGUST 1997

APPLICATION INFORMATION

Large negative transients occurring at the inputs of memory devices (DRAMs, SRAMs, EPROMs, etc.) or on the CLOCK lines of many clocked devices can result in improper operation of the devices. The SN74S1053 diode termination array helps suppress negative transients caused by transmission-line reflections, crosstalk, and switching noise.

Diode terminations have several advantages when compared to resistor termination schemes. Split resistor or Thevenin equivalent termination can cause a substantial increase in power consumption. The use of a single resistor to ground to terminate a line usually results in degradation of the output high level, resulting in reduced noise immunity. Series damping resistors placed on the outputs of the driver reduce negative transients, but they also can increase propagation delays down the line, as a series resistor reduces the output drive capability of the driving device. Diode terminations have none of these drawbacks.

The operation of the diode arrays in reducing negative transients is explained in the following figures. The diode conducts current when the voltage reaches a negative value large enough for the diode to turn on. Suppression of negative transients is tracked by the current-voltage characteristic curve for that diode. Typical current versus voltage curves for the SN74S1053 are shown in Figures 3 and 4.

To illustrate how the diode arrays act to reduce negative transients at the end of a transmission line, the test setup in Figure 5 was evaluated. The resulting waveforms with and without the diode are shown in Figure 6.

The maximum effectiveness of the diode arrays in suppressing negative transients occurs when the diode arrays are placed at the end of a line and/or the end of a long stub branching off a main transmission line. The diodes also can be used to reduce the negative transients that occur due to discontinuities in the middle of a line. An example of this is a slot in a backplane that is provided for an add-on card.

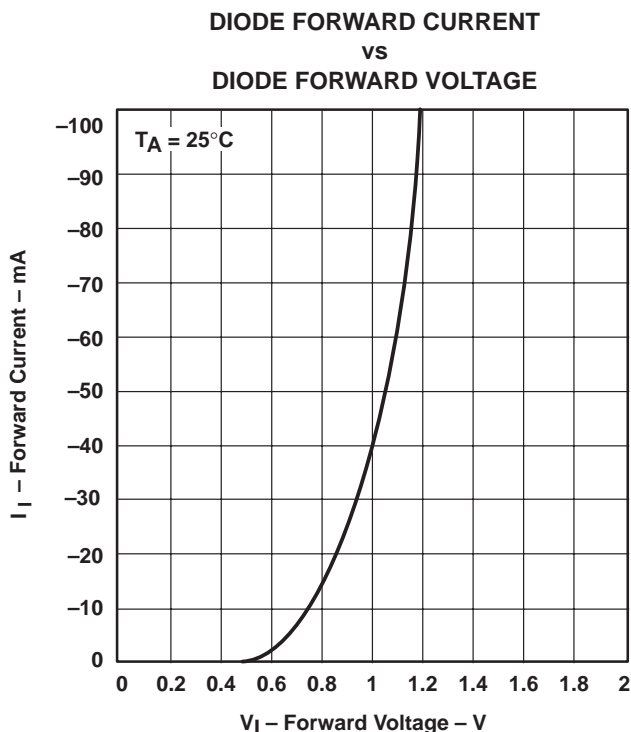
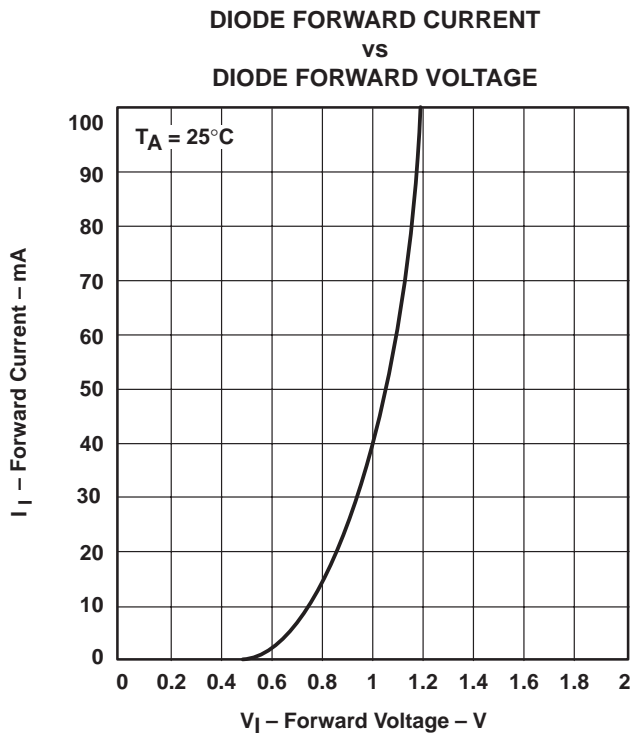

Figure 3. Typical Input Current vs Input Voltage
(Lower Diode)



**Figure 4. Typical Input Current vs Input Voltage
(Upper Diode)**

APPLICATION INFORMATION

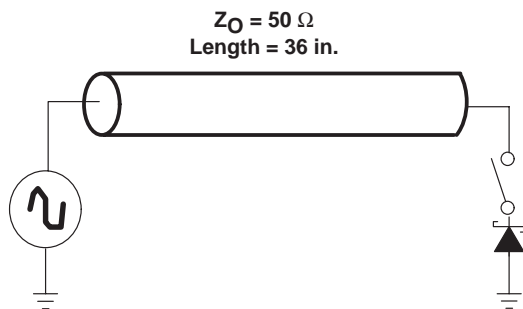

Figure 5. Diode Test Setup

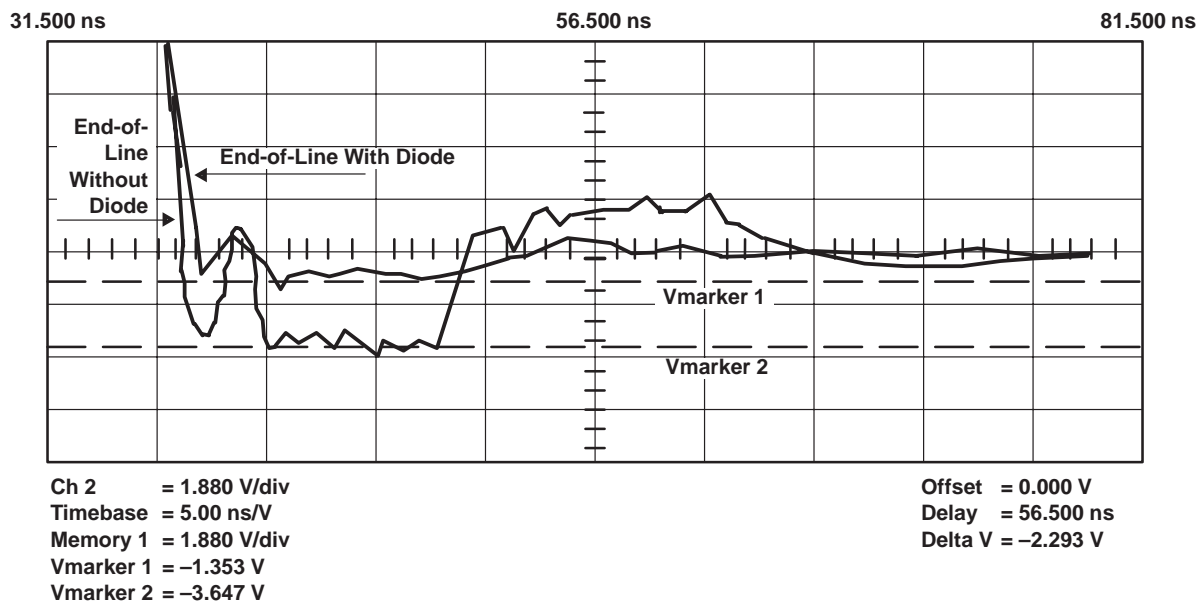

Figure 6. Oscilloscope Display

PACKAGING INFORMATION

Orderable Device	Status ⁽¹⁾	Package Type	Package Drawing	Pins	Package Qty	Eco Plan ⁽²⁾	Lead/Ball Finish	MSL Peak Temp ⁽³⁾
SN74S1053DBR	ACTIVE	SSOP	DB	20	2000	Green (RoHS & no Sb/Br)	CU NIPDAU	Level-1-260C-UNLIM
SN74S1053DBRE4	ACTIVE	SSOP	DB	20	2000	Green (RoHS & no Sb/Br)	CU NIPDAU	Level-1-260C-UNLIM
SN74S1053DBRG4	ACTIVE	SSOP	DB	20	2000	Green (RoHS & no Sb/Br)	CU NIPDAU	Level-1-260C-UNLIM
SN74S1053DW	ACTIVE	SOIC	DW	20	25	Green (RoHS & no Sb/Br)	CU NIPDAU	Level-1-260C-UNLIM
SN74S1053DWG4	ACTIVE	SOIC	DW	20	25	Green (RoHS & no Sb/Br)	CU NIPDAU	Level-1-260C-UNLIM
SN74S1053DWR	ACTIVE	SOIC	DW	20	2000	Green (RoHS & no Sb/Br)	CU NIPDAU	Level-1-260C-UNLIM
SN74S1053DWRG4	ACTIVE	SOIC	DW	20	2000	Green (RoHS & no Sb/Br)	CU NIPDAU	Level-1-260C-UNLIM
SN74S1053N	ACTIVE	PDIP	N	20	20	Pb-Free (RoHS)	CU NIPDAU	N / A for Pkg Type
SN74S1053NE4	ACTIVE	PDIP	N	20	20	Pb-Free (RoHS)	CU NIPDAU	N / A for Pkg Type
SN74S1053NSR	ACTIVE	SO	NS	20	2000	Green (RoHS & no Sb/Br)	CU NIPDAU	Level-1-260C-UNLIM
SN74S1053NSRG4	ACTIVE	SO	NS	20	2000	Green (RoHS & no Sb/Br)	CU NIPDAU	Level-1-260C-UNLIM
SN74S1053PW	ACTIVE	TSSOP	PW	20	70	Green (RoHS & no Sb/Br)	CU NIPDAU	Level-1-260C-UNLIM
SN74S1053PWE4	ACTIVE	TSSOP	PW	20	70	Green (RoHS & no Sb/Br)	CU NIPDAU	Level-1-260C-UNLIM
SN74S1053PWG4	ACTIVE	TSSOP	PW	20	70	Green (RoHS & no Sb/Br)	CU NIPDAU	Level-1-260C-UNLIM
SN74S1053PWR	ACTIVE	TSSOP	PW	20	2000	Green (RoHS & no Sb/Br)	CU NIPDAU	Level-1-260C-UNLIM
SN74S1053PWRE4	ACTIVE	TSSOP	PW	20	2000	Green (RoHS & no Sb/Br)	CU NIPDAU	Level-1-260C-UNLIM
SN74S1053PWRG4	ACTIVE	TSSOP	PW	20	2000	Green (RoHS & no Sb/Br)	CU NIPDAU	Level-1-260C-UNLIM

⁽¹⁾ The marketing status values are defined as follows:

ACTIVE: Product device recommended for new designs.

LIFEBUY: TI has announced that the device will be discontinued, and a lifetime-buy period is in effect.

NRND: Not recommended for new designs. Device is in production to support existing customers, but TI does not recommend using this part in a new design.

PREVIEW: Device has been announced but is not in production. Samples may or may not be available.

OBsolete: TI has discontinued the production of the device.

⁽²⁾ Eco Plan - The planned eco-friendly classification: Pb-Free (RoHS), Pb-Free (RoHS Exempt), or Green (RoHS & no Sb/Br) - please check <http://www.ti.com/productcontent> for the latest availability information and additional product content details.

TBD: The Pb-Free/Green conversion plan has not been defined.

Pb-Free (RoHS): TI's terms "Lead-Free" or "Pb-Free" mean semiconductor products that are compatible with the current RoHS requirements for all 6 substances, including the requirement that lead not exceed 0.1% by weight in homogeneous materials. Where designed to be soldered at high temperatures, TI Pb-Free products are suitable for use in specified lead-free processes.

Pb-Free (RoHS Exempt): This component has a RoHS exemption for either 1) lead-based flip-chip solder bumps used between the die and package, or 2) lead-based die adhesive used between the die and leadframe. The component is otherwise considered Pb-Free (RoHS compatible) as defined above.

Green (RoHS & no Sb/Br): TI defines "Green" to mean Pb-Free (RoHS compatible), and free of Bromine (Br) and Antimony (Sb) based flame

retardants (Br or Sb do not exceed 0.1% by weight in homogeneous material)

(3) MSL, Peak Temp. -- The Moisture Sensitivity Level rating according to the JEDEC industry standard classifications, and peak solder temperature.

Important Information and Disclaimer:The information provided on this page represents TI's knowledge and belief as of the date that it is provided. TI bases its knowledge and belief on information provided by third parties, and makes no representation or warranty as to the accuracy of such information. Efforts are underway to better integrate information from third parties. TI has taken and continues to take reasonable steps to provide representative and accurate information but may not have conducted destructive testing or chemical analysis on incoming materials and chemicals. TI and TI suppliers consider certain information to be proprietary, and thus CAS numbers and other limited information may not be available for release.

In no event shall TI's liability arising out of such information exceed the total purchase price of the TI part(s) at issue in this document sold by TI to Customer on an annual basis.

TAPE AND REEL INFORMATION



QUADRANT ASSIGNMENTS FOR PIN 1 ORIENTATION IN TAPE



*All dimensions are nominal

Device	Package Type	Package Drawing	Pins	SPQ	Reel Diameter (mm)	Reel Width W1 (mm)	A0 (mm)	B0 (mm)	K0 (mm)	P1 (mm)	W (mm)	Pin1 Quadrant
SN74S1053DBR	SSOP	DB	20	2000	330.0	16.4	8.2	7.5	2.5	12.0	16.0	Q1
SN74S1053DWR	SOIC	DW	20	2000	330.0	24.4	10.8	13.0	2.7	12.0	24.0	Q1
SN74S1053NSR	SO	NS	20	2000	330.0	24.4	8.2	13.0	2.5	12.0	24.0	Q1
SN74S1053PWR	TSSOP	PW	20	2000	330.0	16.4	6.95	7.1	1.6	8.0	16.0	Q1

TAPE AND REEL BOX DIMENSIONS

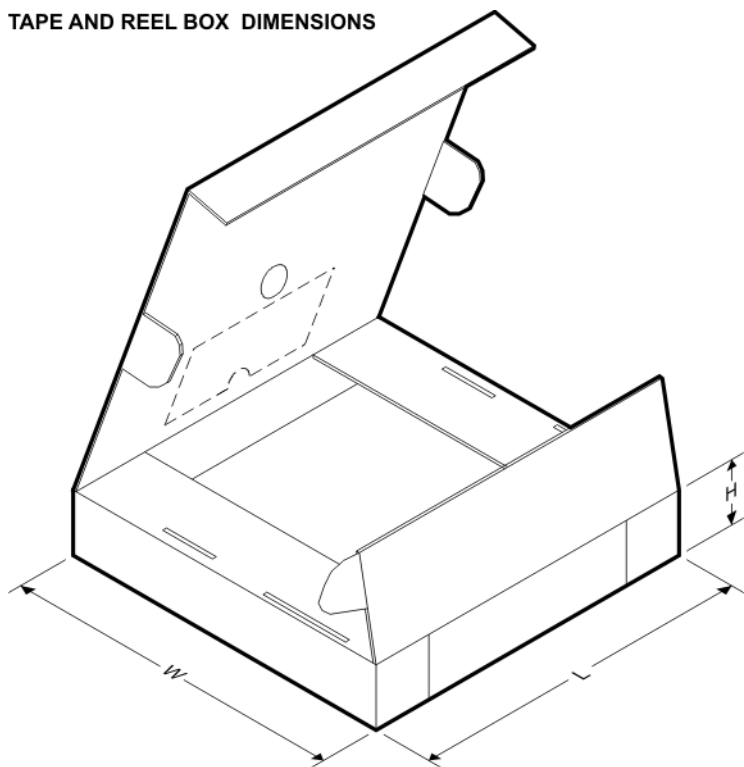

*All dimensions are nominal

Device	Package Type	Package Drawing	Pins	SPQ	Length (mm)	Width (mm)	Height (mm)
SN74S1053DBR	SSOP	DB	20	2000	346.0	346.0	33.0
SN74S1053DWR	SOIC	DW	20	2000	346.0	346.0	41.0
SN74S1053NSR	SO	NS	20	2000	346.0	346.0	41.0
SN74S1053PWR	TSSOP	PW	20	2000	346.0	346.0	33.0

DB (R-PDSO-G**)

PLASTIC SMALL-OUTLINE

28 PINS SHOWN



4040065 /E 12/01

- NOTES: A. All linear dimensions are in millimeters.
 B. This drawing is subject to change without notice.
 C. Body dimensions do not include mold flash or protrusion not to exceed 0,15.
 D. Falls within JEDEC MO-150

PW (R-PDSO-G**)

PLASTIC SMALL-OUTLINE PACKAGE

14 PINS SHOWN



4040064/F 01/97

- NOTES: A. All linear dimensions are in millimeters.
 B. This drawing is subject to change without notice.
 C. Body dimensions do not include mold flash or protrusion not to exceed 0,15.
 D. Falls within JEDEC MO-153

MECHANICAL DATA

NS (R-PDSO-G**)

PLASTIC SMALL-OUTLINE PACKAGE

14-PINS SHOWN



- NOTES:
- A. All linear dimensions are in millimeters.
 - B. This drawing is subject to change without notice.
 - C. Body dimensions do not include mold flash or protrusion, not to exceed 0,15.

DW (R-PDSO-G20)

PLASTIC SMALL-OUTLINE PACKAGE



- NOTES:
- A. All linear dimensions are in inches (millimeters).
 - B. This drawing is subject to change without notice.
 - C. Body dimensions do not include mold flash or protrusion not to exceed 0.006 (0,15).
 - D. Falls within JEDEC MS-013 variation AC.

N (R-PDIP-T**)

PLASTIC DUAL-IN-LINE PACKAGE

16 PINS SHOWN



4040049/E 12/2002

- NOTES:
- A. All linear dimensions are in inches (millimeters).
 - B. This drawing is subject to change without notice.
 - $\triangle C$ Falls within JEDEC MS-001, except 18 and 20 pin minimum body length (Dim A).
 - $\triangle D$ The 20 pin end lead shoulder width is a vendor option, either half or full width.

IMPORTANT NOTICE

Texas Instruments Incorporated and its subsidiaries (TI) reserve the right to make corrections, modifications, enhancements, improvements, and other changes to its products and services at any time and to discontinue any product or service without notice. Customers should obtain the latest relevant information before placing orders and should verify that such information is current and complete. All products are sold subject to TI's terms and conditions of sale supplied at the time of order acknowledgment.

TI warrants performance of its hardware products to the specifications applicable at the time of sale in accordance with TI's standard warranty. Testing and other quality control techniques are used to the extent TI deems necessary to support this warranty. Except where mandated by government requirements, testing of all parameters of each product is not necessarily performed.

TI assumes no liability for applications assistance or customer product design. Customers are responsible for their products and applications using TI components. To minimize the risks associated with customer products and applications, customers should provide adequate design and operating safeguards.

TI does not warrant or represent that any license, either express or implied, is granted under any TI patent right, copyright, mask work right, or other TI intellectual property right relating to any combination, machine, or process in which TI products or services are used. Information published by TI regarding third-party products or services does not constitute a license from TI to use such products or services or a warranty or endorsement thereof. Use of such information may require a license from a third party under the patents or other intellectual property of the third party, or a license from TI under the patents or other intellectual property of TI.

Reproduction of TI information in TI data books or data sheets is permissible only if reproduction is without alteration and is accompanied by all associated warranties, conditions, limitations, and notices. Reproduction of this information with alteration is an unfair and deceptive business practice. TI is not responsible or liable for such altered documentation. Information of third parties may be subject to additional restrictions.

Resale of TI products or services with statements different from or beyond the parameters stated by TI for that product or service voids all express and any implied warranties for the associated TI product or service and is an unfair and deceptive business practice. TI is not responsible or liable for any such statements.

TI products are not authorized for use in safety-critical applications (such as life support) where a failure of the TI product would reasonably be expected to cause severe personal injury or death, unless officers of the parties have executed an agreement specifically governing such use. Buyers represent that they have all necessary expertise in the safety and regulatory ramifications of their applications, and acknowledge and agree that they are solely responsible for all legal, regulatory and safety-related requirements concerning their products and any use of TI products in such safety-critical applications, notwithstanding any applications-related information or support that may be provided by TI. Further, Buyers must fully indemnify TI and its representatives against any damages arising out of the use of TI products in such safety-critical applications.

TI products are neither designed nor intended for use in military/aerospace applications or environments unless the TI products are specifically designated by TI as military-grade or "enhanced plastic." Only products designated by TI as military-grade meet military specifications. Buyers acknowledge and agree that any such use of TI products which TI has not designated as military-grade is solely at the Buyer's risk, and that they are solely responsible for compliance with all legal and regulatory requirements in connection with such use.

TI products are neither designed nor intended for use in automotive applications or environments unless the specific TI products are designated by TI as compliant with ISO/TS 16949 requirements. Buyers acknowledge and agree that, if they use any non-designated products in automotive applications, TI will not be responsible for any failure to meet such requirements.

Following are URLs where you can obtain information on other Texas Instruments products and application solutions:

Products

Amplifiers	amplifier.ti.com
Data Converters	dataconverter.ti.com
DSP	dsp.ti.com
Clocks and Timers	www.ti.com/clocks
Interface	interface.ti.com
Logic	logic.ti.com
Power Mgmt	power.ti.com
Microcontrollers	microcontroller.ti.com
RFID	www.ti-rfid.com
RF/IF and ZigBee® Solutions	www.ti.com/lprf

Applications

Audio	www.ti.com/audio
Automotive	www.ti.com/automotive
Broadband	www.ti.com/broadband
Digital Control	www.ti.com/digitalcontrol
Medical	www.ti.com/medical
Military	www.ti.com/military
Optical Networking	www.ti.com/opticalnetwork
Security	www.ti.com/security
Telephony	www.ti.com/telephony
Video & Imaging	www.ti.com/video
Wireless	www.ti.com/wireless

Mailing Address: Texas Instruments, Post Office Box 655303, Dallas, Texas 75265
Copyright © 2008, Texas Instruments Incorporated