

Spezifikation für Freigabe / specification for release

Kunde / customer :
 Artikelnummer / part number : **7443550820**
 Bezeichnung : **SPEICHERDROSSEL WE-HCI**
 description : **POWER-CHOKE WE-HCI**



DATUM / DATE : 2009-08-14

A Mechanische Abmessungen / dimensions :

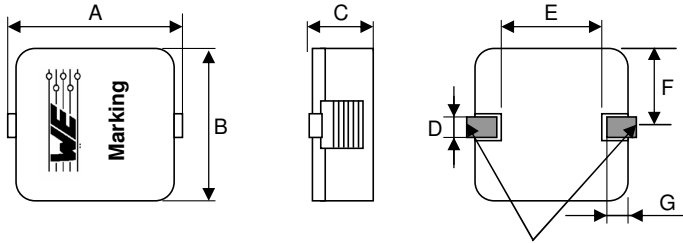

RDC is measured at these points

A	13,0 ± 1,0	mm
B	12,8 ± 0,5	mm
C	4,7 ± 0,3	mm
D	2,5 ± 0,5	mm
E	6,0 ± 0,5	mm
F	6,4 ± 0,5	mm
G	3,0 ± 1,0	mm

Marking = part number

B Elektrische Eigenschaften / electrical properties :

Eigenschaften / properties	Testbedingungen / test conditions		Wert / value	Einheit / unit	tol.
Lerrlaufinduktivität / initial inductance	100 kHz / 10mA	L_0	8,20	μH	± 20%
Nenn-Induktivität / rated inductance	100 kHz / 10mA / 10A	L_N	6,10	μH	typ.
DC-Widerstand / DC-resistance	@ 20° C	R_{DC}	11,60	$\text{m}\Omega$	± 10%
Nennstrom / rated current	$\Delta T = 50 \text{ K}$	I_N	10,0	A	typ.
Sättigungsstrom / saturation current	$\Delta L / L_0 = 30 \%$	I_{sat}	11,0	A	typ.
Eigenres.-Frequenz / self-res.-frequency		SRF	20	MHz	typ.

C Lötpad / soldering spec.:

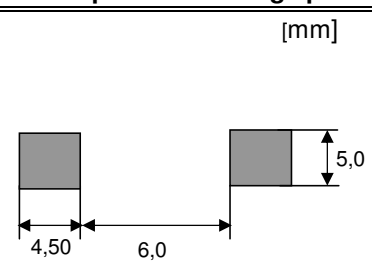

D Prüfgeräte / test equipment :

WAYNE KERR 3260B für/for L_0 ; I_{SAT}
HP 34401 A & Fluke 54II für/for I_{DC} ;
Metra HIT 27I für/for R_{DC}

E Testbedingungen / test conditions :

Luftfeuchtigkeit / humidity: 33%
 Umgebungstemperatur / temperature: +20°C

F Werkstoffe & Zulassungen / material & approvals :

Basismaterial / base material: WE-Perm
 Draht / wire: AIEIW-200

G Eigenschaften / general specifications :

Arbeitstemperatur / operating temperature: -40°C - +155°C
 Umgebungstemp. / ambient temperature: -40°C - +105°C
 It is recommended that the temperature of the part does not exceed 155°C under worst case operating conditions.

Freigabe erteilt / general release:	Kunde / customer			
Datum / date	Unterschrift / signature			
	Würth Elektronik			
		ME	Version 1	09-08-14
Geprüft / checked	Kontrolliert / approved	Name	Änderung / modification	Datum / date

Würth Elektronik eiSos GmbH & Co. KG

D-74638 Waldenburg · Max-Eyth-Strasse 1 - 3 · Germany · Telefon (+49) (0) 7942 - 945 - 0 · Telefax (+49) (0) 7942 - 945 - 400
<http://www.we-online.de>

Spezifikation für Freigabe / specification for release

Kunde / customer :
 Artikelnummer / part number : **7443550820**
 Bezeichnung : **SPEICHERDROSSEL WE-HCI**
 description : **POWER-CHOKE WE-HCI**

LF



DATUM / DATE : 2009-08-14

H Induktivitätskurve / Inductance curve :

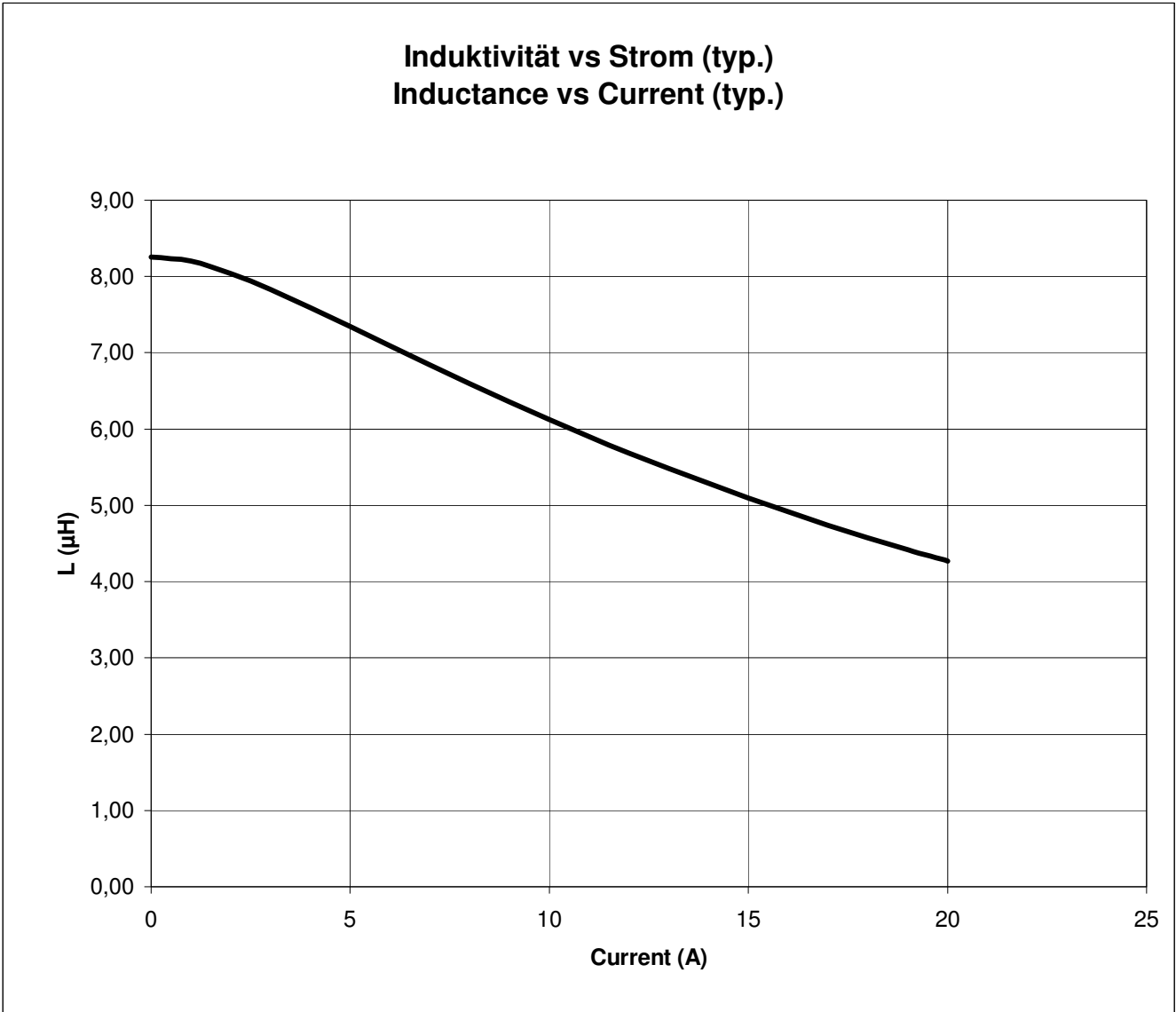

Freigabe erteilt / general release:	Kunde / customer			
.....			
Datum / date	Unterschrift / signature			
	Würth Elektronik			
.....			
Geprüft / checked	Kontrolliert / approved	ME	Version 1	09-08-14
		Name	Änderung / modification	Datum / date

Würth Elektronik eiSos GmbH & Co. KG

D-74638 Waldenburg · Max-Eyth-Strasse 1 - 3 · Germany · Telefon (+49) (0) 7942 - 945 - 0 · Telefax (+49) (0) 7942 - 945 - 400
<http://www.we-online.de>

Spezifikation für Freigabe / specification for release

Kunde / customer :

Artikelnummer / part number :

7443550820

LF



Bezeichnung :

description :

WÜRTH ELEKTRONIK

DATUM / DATE : 2009-08-14

I Temperaturanstieg / Temperature rise curve :

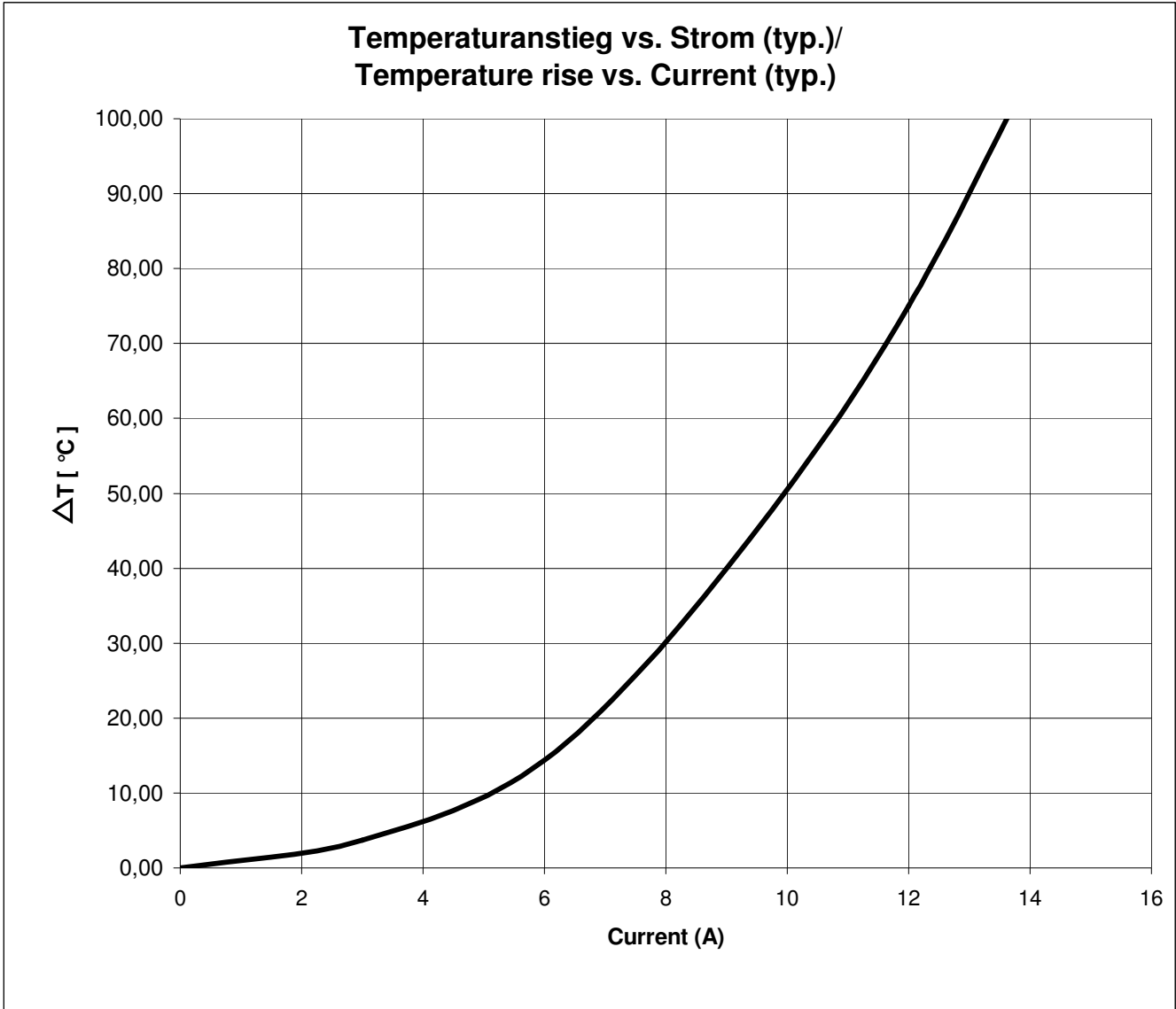

Freigabe erteilt / general release:	Kunde / customer			
.....			
Datum / date	Unterschrift / signature			
	Würth Elektronik			
.....			
Geprüft / checked	Kontrolliert / approved	ME	Version 1	09-08-14
		Name	Änderung / modification	Datum / date

Würth Elektronik eiSos GmbH & Co. KG

D-74638 Waldenburg · Max-Eyth-Strasse 1 - 3 · Germany · Telefon (+49) (0) 7942 - 945 - 0 · Telefax (+49) (0) 7942 - 945 - 400
<http://www.we-online.de>

Spezifikation für Freigabe / specification for release

Kunde / customer :

Artikelnummer / part number :

7443550820

LF



Bezeichnung : **SPEICHERDROSSEL WE-HCI**

description : **POWER-CHOKER WE-HCI**

DATUM / DATE : 2009-08-14

I Rollenspezifikation / tape and reel specification :

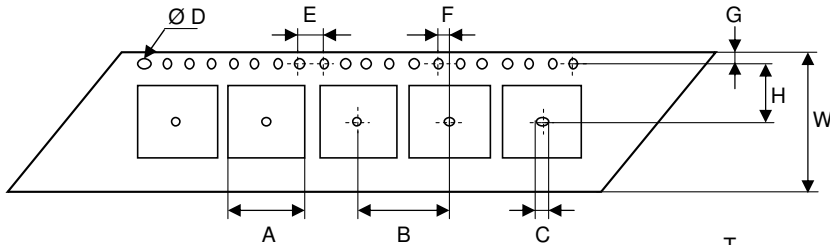

Gurtspezifikation / Tape specification:

A	14 ± 0,1	mm
B	16,0 ± 0,1	mm
C	1,50 + 0,1 - 0,0	mm
D	1,50 + 0,1 - 0,0	mm
E	4,00 ± 0,1	mm
F	2,00 ± 0,1	mm
G	1,75 ± 0,1	mm
H	11,5 ± 0,1	mm
I	13,6 ± 0,1	mm
J	6,10 ± 0,1	mm
T	0,40 ± 0,05	mm
W	24,0 ± 0,3	mm

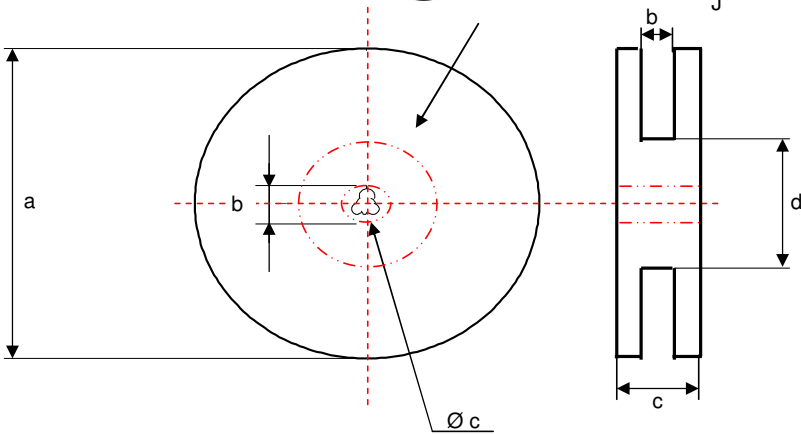
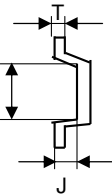

Rollenspezifikation / Reel specification:

a	330,0 ± 2,0	mm
b	24,5 ± 0,8	mm
c	29,5 ± 0,5	mm
d	100,0 ± 1,5	mm

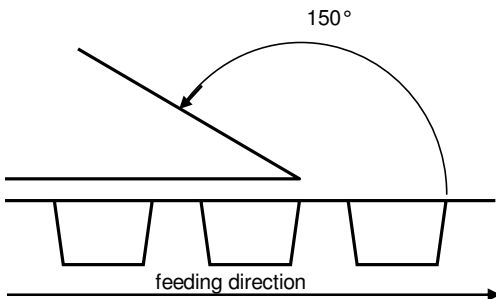

The Force for tearing off cover tape is 20 to 70 grams in arrow direction

Freigabe erteilt / general release:	Kunde / customer			
Datum / date	Unterschrift / signature			
	Würth Elektronik			
Geprüft / checked	Kontrolliert / approved			
		ME	Version 1	09-08-14
		Name	Änderung / modification	Datum / date

This electronic component has been designed and developed for usage in general electronic equipment. Before incorporating this component into any equipment where higher safety and reliability is especially required or if there is the possibility of direct damage or injury to human body, for example in the range of aerospace, aviation, nuclear control, submarine, transportation, (automotive control, train control, ship control), transportation signal, disaster prevention, medical, public information network etc, Würth Elektronik eiSos GmbH must be informed before the design-in stage. In addition, sufficient reliability evaluation checks for safety must be performed on every electronic component which is used in electrical circuits that require high safety and reliability functions or performance.

Würth Elektronik eiSos GmbH & Co. KG

D-74638 Waldenburg · Max-Eyth-Strasse 1 - 3 · Germany · Telefon (+49) (0) 7942 - 945 - 0 · Telefax (+49) (0) 7942 - 945 - 400

<http://www.we-online.com>