

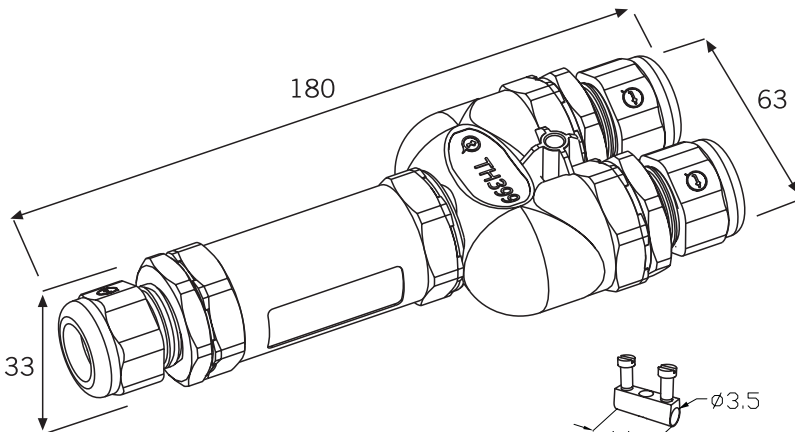

# TH399

PATENTED IP68

2-3-5-6  
3+3  
Poli



Capacita' di connessione fino a 6°  
Connection capability up to 6°

Morsettiera lineare a 3 vie. Uscita a "Y" elevato grado IP.

Protected connection solution of the linear type with "Y" exit and high IP rate.

## Dati tecnici - Technical data

250 V~	4 °	IP68
PTI 250	T85° C	2 BAR

Tipo di cavo utilizzabile in funzione della temperatura ambiente			
Temperatura ambiente Ambient temperature	Tipo di cavo utilizzabile Suitable cable	Sezione minima Smallest cross-sectional	Sezione massima Largest cross-sectional
T85	H05SS-F	3G1,5mm <sup>2</sup> 5G1,5mm <sup>2</sup>	3G 4mm <sup>2</sup> 5G2,5mm <sup>2</sup>

Coppia torsione Torque force	Tube-Corpo pressacavo Tube-Cable gland body	Corpo pressacavo-Dado Cable gland body-Nut
2-3-5-6 3+3 P	2.5 Nm  29	2.5 Nm  24 4 Nm  29

## Materie prime - Raw materials

### Materia plastica - Plastics

PA66 UL94 V2 GWT 850°C  
PA66GF UL94 V0 GWT 960°C

■ Nero - Black

-20°C
+125°C

### Gomme - Rubbers

Gommini- *sealing inserts*: TPE-V - NBR  
Guarnizioni - *seals*: SILICONE *silicon*

### Bussole- Insert



Acciaio zincato passivato  
Zinc plated steel

Ottone nichelato Nickel plated brass	A B C
Bussola cieca End barrier insert	
Bussola STD STD insert Bussola WP WP insert	

## Norme - Standards

EN60529:1991+A1:2000-  
IP68:20MT-PROF;60 MIN  
EN 60998-1:2004  
EN 60998-2-1:2004



## Codice - Part number

T H B . 3 9 9 . X X X

LUNGO  
LONG

Min-Max Ø cavo - cable 5÷17 mm

### 2 poli-2 poles

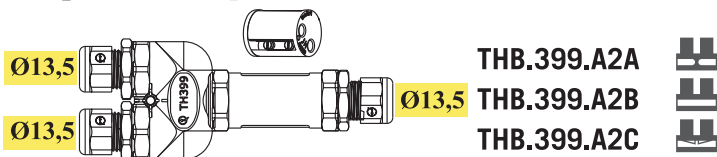

### 3 poli-3 poles

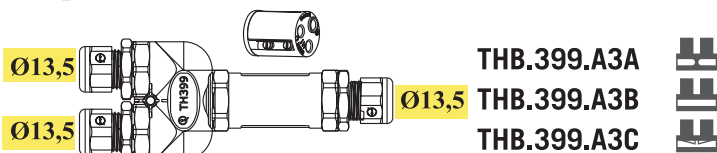

### 5 poli-5 poles

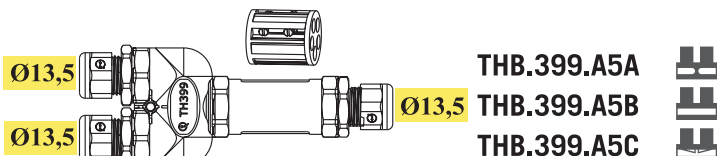

### 6 poli-6 poles

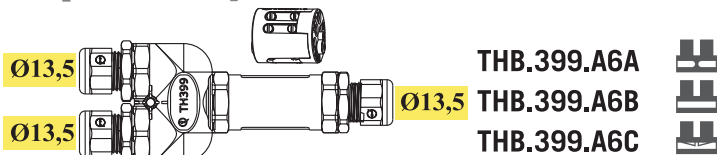

### 2+2 poli-2+2 poles

### 3+3 poli-3+3 poles

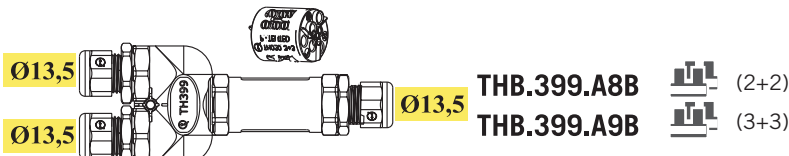

Eventuali modifiche e migliorie sui dati tecnici o sul prodotto potranno essere effettuate senza preavviso.  
All technical data or other eventual product modifications and improvements can be carried out without notice

### 2 poli-2 poles

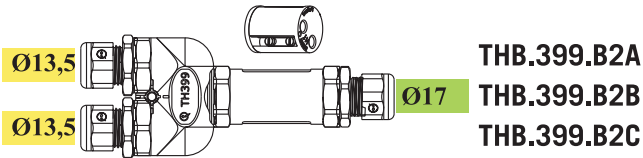

### 3 poli-3 poles

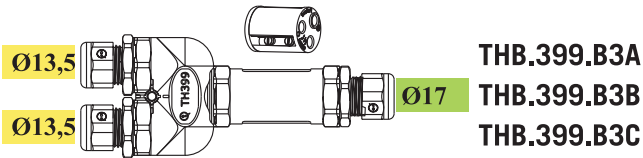

### 5 poli-5 poles

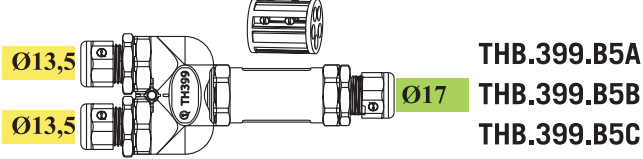

### 6 poli-6 poles

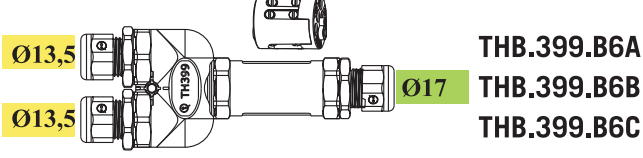

### 2+2 poli-2+2 poles 3+3 poli-3+3 poles

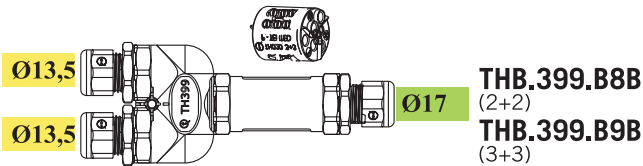

### 2 poli-2 poles

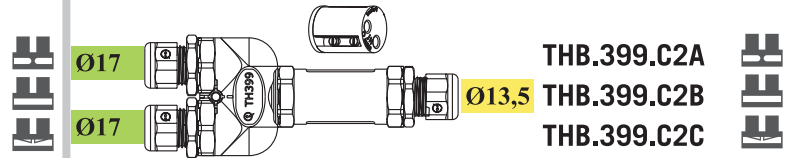

### 3 poli-3 poles

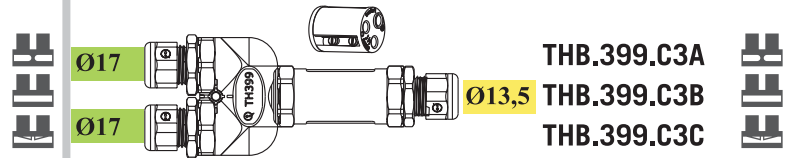

### 5 poli-5 poles

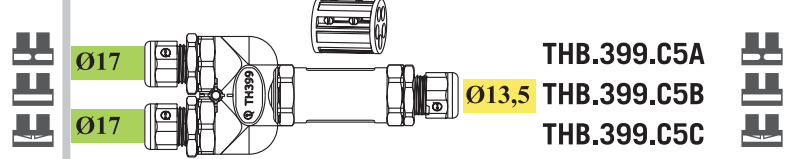

### 6 poli-6 poles

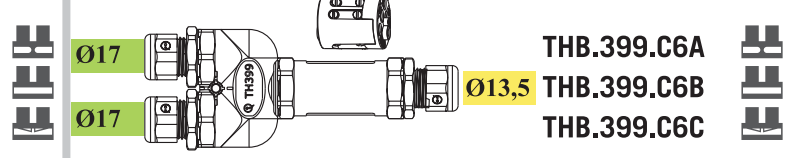

### 2+2 poli-2+2 poles 3+3 poli-3+3 poles

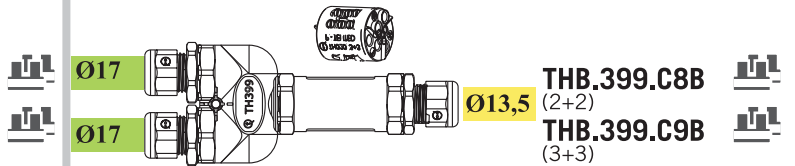

### 2 poli-2 poles

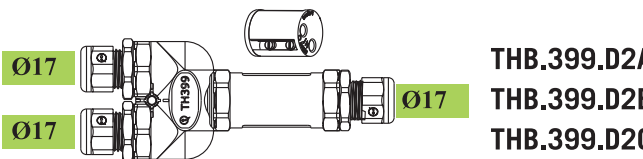

### 3 poli-3 poles

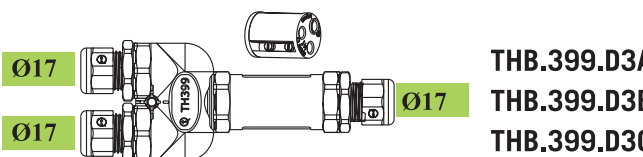

### 5 poli-5 poles

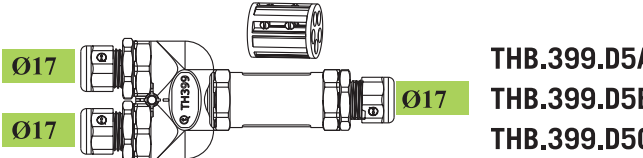

### 6 poli-6 poles

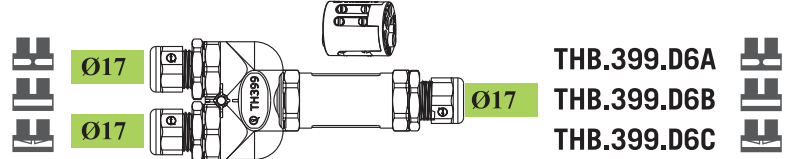

### 2+2 poli-2+2 poles 3+3 poli-3+3 poles

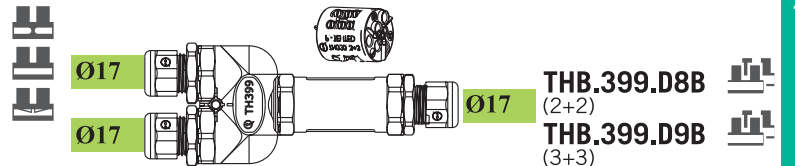

## Kit di fornitura non assemblato THB Unassembled kit THB

**THB.399.XXX**  
*VERSIONE A LUNGA  
LONG VERSION*

Min-Max Ø cavo - cable Ⓟ Ⓢ Ø 8÷17 mm

**THB.399.EXX**  
*VERSIONE CORTA  
SMALL VERSION*

Min-Max Ø cavo - cable Ⓟ Ⓢ Ø 5÷13,5 mm

## Kit di fornitura assemblato THZ Assembled kit THZ

**THZ.399.XXX**

**THZ.399.EXX**

## Kit di fornitura imbustati THR Fare riferimento a catalogo THR Retail packed kit THR Please refer to THR Retail Catalogue

**THR.399.SXX**

## Kit di fornitura con versionamenti e confezionamenti speciali THK Special custom packed version THK

**THK.399.XXX**

Vedi istruzioni di assemblaggio  
Refer to user instructions