

DFK-PC 5/ 6-G-7,62

Order No.: 1727621

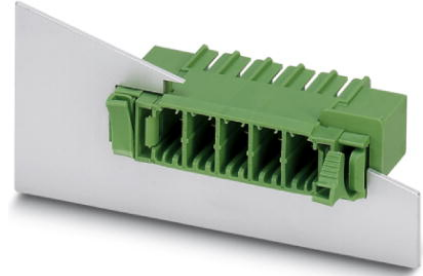

<http://eshop.phoenixcontact.net/phoenix/treeViewClick.do?UID=1727621>

Header, Nominal current: 41 A, Nom. voltage: 500 V, Pitch: 7.62 mm,
Number of positions: 6, Color: green, Assembly: Soldering

Commercial data

EAN	4046356135764
Pack	10 pcs.
Customs tariff	85366990
Weight/Piece	0.02814 KG
Catalog page information	Page 398 (CC-2009)

Product notes

WEEE/RoHS-compliant since:
04/18/2006



<http://www.download.phoenixcontact.com>
Please note that the data given here has been taken from the online catalog. For comprehensive information and data, please refer to the user documentation. The General Terms and Conditions of Use apply to Internet downloads.

Technical data

Dimensions / positions

Pitch	7.62 mm
Dimension a	38.1 mm
Number of positions	6
Pin dimensions	0,8 x 1,0
Pin spacing	7.62 mm

Hole diameter	1.3 mm
Technical data	
Insulating material group	I
Rated surge voltage (III/3)	6 kV
Rated surge voltage (III/2)	6 kV
Rated surge voltage (II/2)	6 kV
Rated voltage (III/2)	630 V
Rated voltage (II/2)	800 V
Connection in acc. with standard	EN-VDE
Nominal current I_N	41 A
Nominal voltage U_N	500 V
Maximum load current	41 A
Insulating material	PA
Inflammability class acc. to UL 94	V0

Diagrams/Drawings

Drilling plan/solder pad geometry

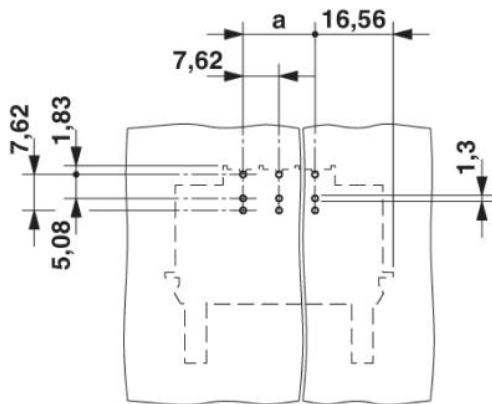

Dimensioned drawing

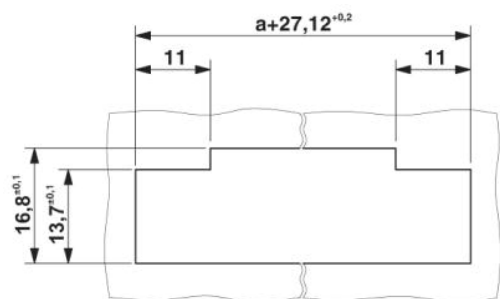

Sheet metal cutout for snap-on.

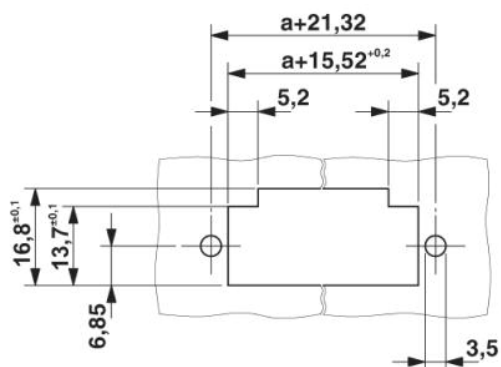

Sheet metal cutout for screw connection.

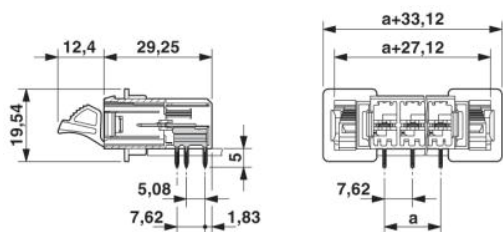

Address

PHOENIX CONTACT GmbH & Co. KG
Flachsmarktstr. 8
32825 Blomberg, Germany
Phone +49 5235 3 00
Fax +49 5235 3 41200
<http://www.phoenixcontact.com>



© 2010 Phoenix Contact
Technical modifications reserved;