

$$I_{F(AV)} = 6\text{Amp}$$

$$V_R = 35 \text{ to } 45\text{V}$$

Major Ratings and Characteristics



Characteristics	6TQ	Units
$I_{F(AV)}$ Rectangular waveform	6	A
V_{RRM} range	35 to 45	V
I_{FSM} @tp=5µs sine	690	A
V_F @6Apk, $T_J = 125^\circ\text{C}$	0.53	V
T_J range	-55 to 175	$^\circ\text{C}$

Description/Features

The 6TQ Schottky rectifier series has been optimized for low reverse leakage at high temperature. The proprietary barrier technology allows for reliable operation up to 175° C junction temperature. Typical applications are in switching power supplies, converters, free-wheeling diodes, and reverse battery protection.

- 175° C T_J operation
- High purity, high temperature epoxy encapsulation for enhanced mechanical strength and moisture resistance
- Low forward voltage drop
- High frequency operation
- Guard ring for enhanced ruggedness and long term reliability

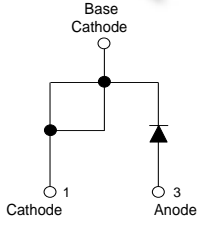
Case Styles

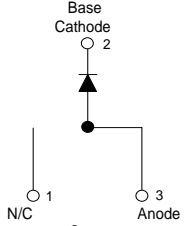
6TQ...	6TQ... S
 <p>Base Cathode</p>  <p>Cathode 1 Anode 3</p> <p>TO-220</p>	 <p>Base Cathode</p>  <p>N/C 1 Anode 3</p> <p>D²PAK</p>

6TQ... Series

Bulletin PD-20283 rev. A 05/02

International
IR Rectifier

Voltage Ratings

Part number	6TQ035	6TQ040	6TQ045
V_R Max. DC Reverse Voltage (V)	35	40	45
V_{RWM} Max. Working Peak Reverse Voltage (V)			

Absolute Maximum Ratings

Parameters	6TQ	Units	Conditions
$I_{F(AV)}$ Max. Average Forward Current * See Fig. 5	6	A	50% duty cycle @ $T_C = 164^\circ\text{C}$, rectangular wave form
I_{FSM} Max. Peak One Cycle Non-Repetitive Surge Current * See Fig. 7	690	A	5 μs Sine or 3 μs Rect. pulse
	140		10ms Sine or 6ms Rect. pulse
E_{AS} Non-Repetitive Avalanche Energy	8	mJ	$T_J = 25^\circ\text{C}$, $I_{AS} = 1.20\text{Amps}$, $L = 11.10\text{mH}$
I_{AR} Repetitive Avalanche Current	1.20	A	Current decaying linearly to zero in 1 μsec Frequency limited by T_J max. $V_A = 1.5 \times V_R$ typical

Electrical Specifications

Parameters	6TQ	Units	Conditions
V_{FM} Max. Forward Voltage Drop (1) * See Fig. 1	0.60	V	@ 6A
	0.73	V	@ 12A
	0.53	V	@ 6A
	0.64	V	@ 12A
I_{RM} Max. Reverse Leakage Current (1) * See Fig. 2	0.8	mA	$T_J = 25^\circ\text{C}$
	7	mA	$T_J = 125^\circ\text{C}$
$V_{F(TO)}$ Threshold Voltage	0.35	V	$T_J = T_J$ max.
r_f Forward Slope Resistance	18.23	m Ω	
C_T Max. Junction Capacitance	400	pF	$V_R = 5V_{DC}$, (test signal range 100Khz to 1Mhz) 25°C
L_S Typical Series Inductance	8.0	nH	Measured lead to lead 5mm from package body
dv/dt Max. Voltage Rate of Change	10000	V/ μs	(Rated V_R)

(1) Pulse Width < 300 μs , Duty Cycle < 2%

Thermal-Mechanical Specifications

Parameters	6TQ	Units	Conditions
T_J Max. Junction Temperature Range	-55 to 175	$^\circ\text{C}$	
T_{stg} Max. Storage Temperature Range	-55 to 175	$^\circ\text{C}$	
R_{thJC} Max. Thermal Resistance Junction to Case	2.2	$^\circ\text{C/W}$	DC operation * See Fig. 4
R_{thCS} Typical Thermal Resistance, Case to Heatsink	0.50	$^\circ\text{C/W}$	Mounting surface, smooth and greased
wt Approximate Weight	2(0.07)	g(oz.)	
T Mounting Torque	Min.	6(5)	Kg-cm (lbf-in)
	Max.	12(10)	

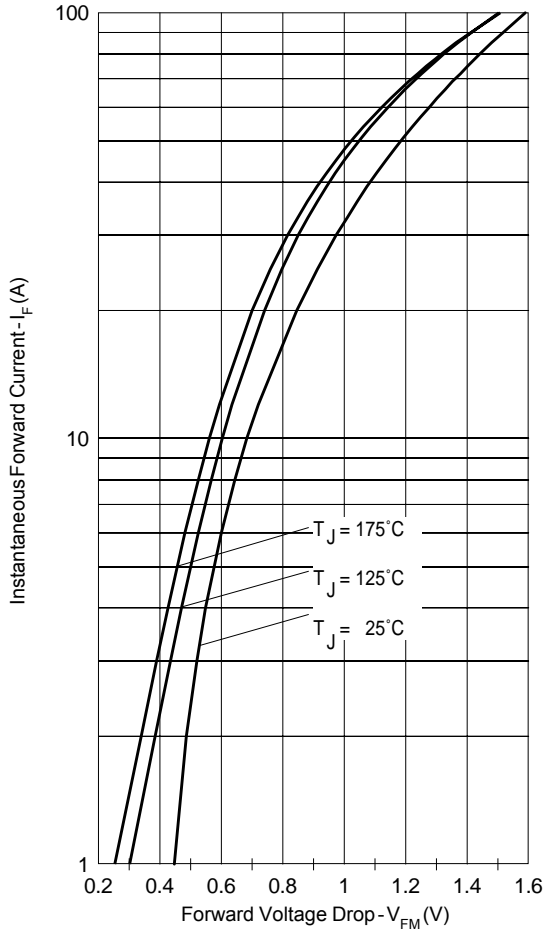

Fig. 1 - Maximum Forward Voltage Drop Characteristics

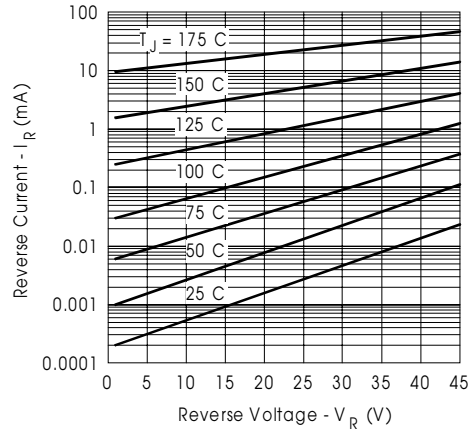

Fig. 2 - Typical Values of Reverse Current Vs. Reverse Voltage

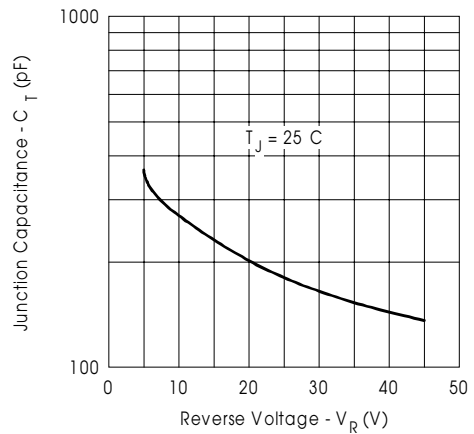

Fig. 3 - Typical Junction Capacitance Vs. Reverse Voltage

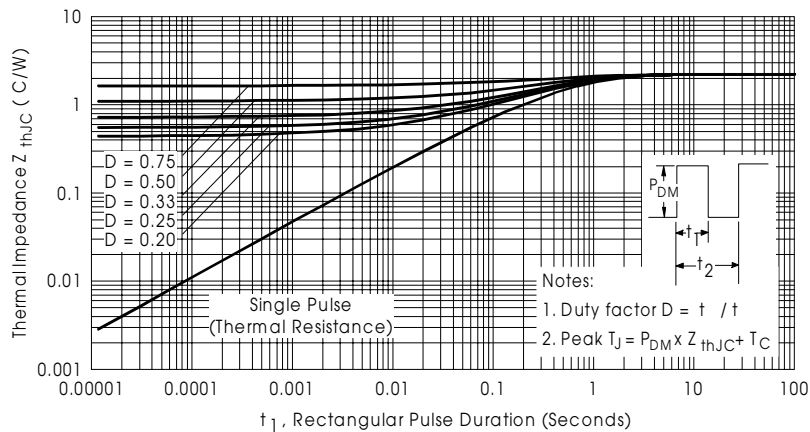

Fig. 4 - Maximum Thermal Impedance Z_{thJC} Characteristics

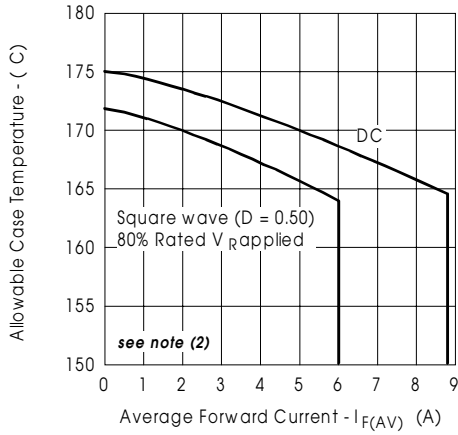

Fig. 5 - Maximum Allowable Case Temperature Vs. Average Forward Current

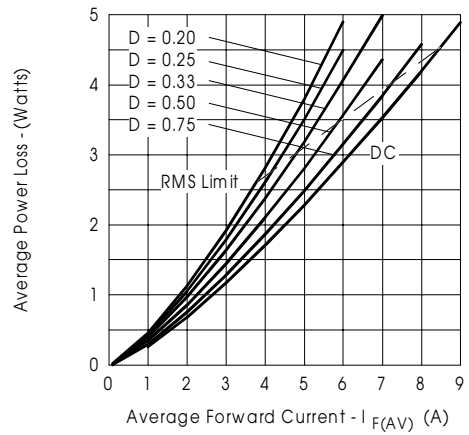

Fig. 6 - Forward Power Loss Characteristics

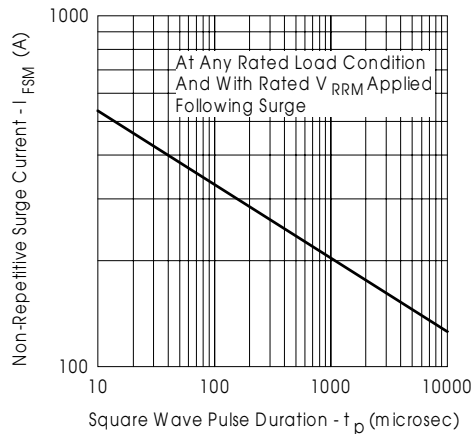

Fig. 7 - Maximum Non-Repetitive Surge Current

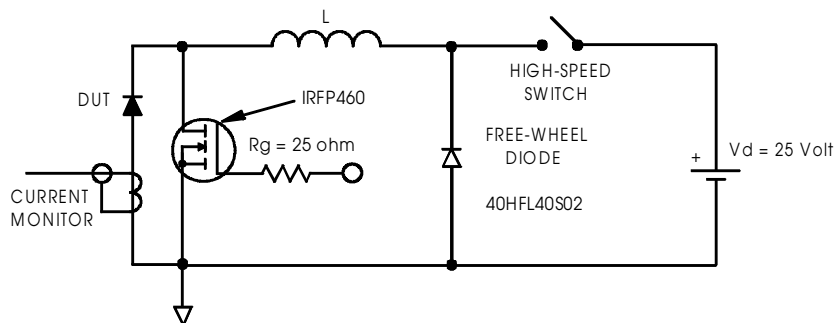

Fig. 8 - Unclamped Inductive Test Circuit

(2) Formula used: $T_C = T_J - (Pd + Pd_{REV}) \times R_{thJC}$;

$Pd = \text{Forward Power Loss} = I_{F(AV)} \times V_{FM} @ (I_{F(AV)} / D)$ (see Fig. 6);

$Pd_{REV} = \text{Inverse Power Loss} = V_{R1} \times I_{R1} (1 - D)$; $I_{R1} @ V_{R1} = 80\% \text{ rated } V_R$

Outline Table

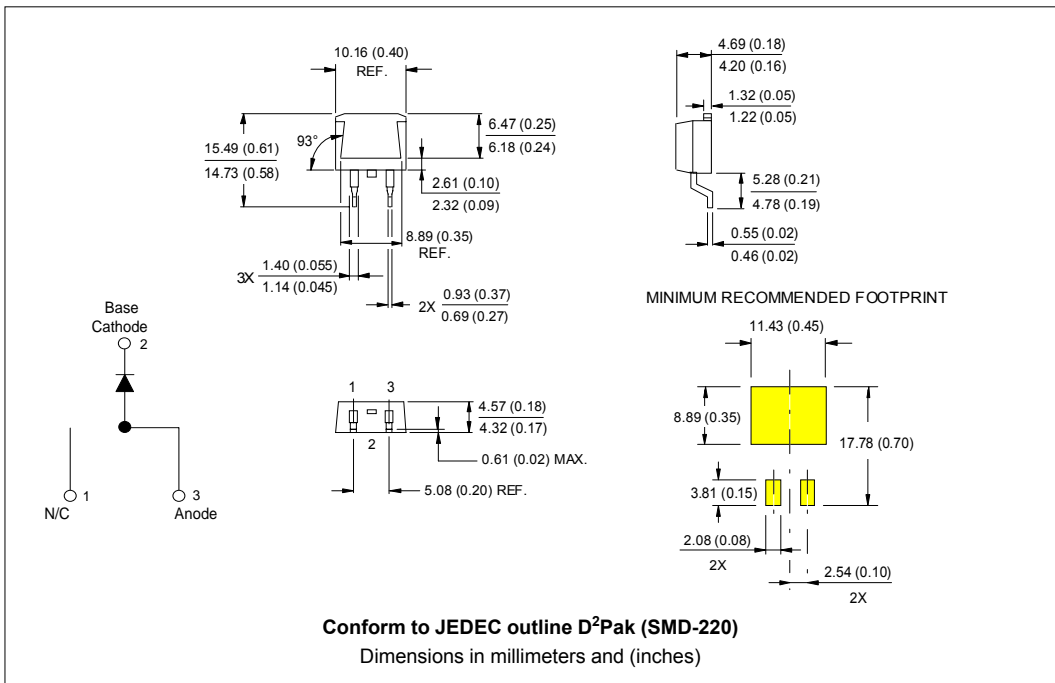
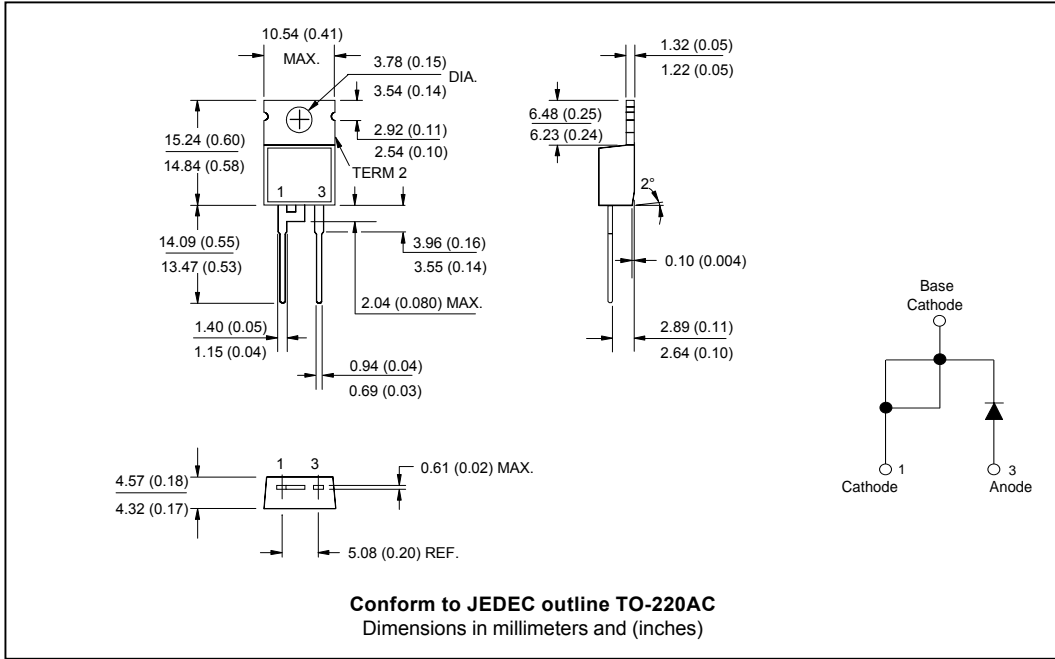

Ordering Information Table

Device Code

6	T	Q	045	S
①	②	③	④	⑤

① - Essential Part Number
② - T = TO-220
③ - Q = Schottky Q Series
④ - Voltage Rating
⑤ - S = D²Pak

035 = 35V
040 = 40V
045 = 45V

Data and specifications subject to change without notice.
This product has been designed and qualified for Industrial Level.
Qualification Standards can be found on IR's Web site.

This datasheet has been download from:

www.datasheetcatalog.com

Datasheets for electronics components.