

Miniatursteckverbinder Serie 440 Miniature connectors series 440

Bezeichnung
Description

Kabelstecker
Male cable connector

Kabeldose
Female cable connector

Abbildung
Figure



Maßzeichnung
Drawing

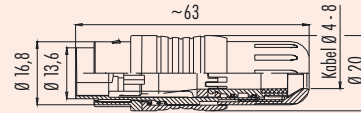
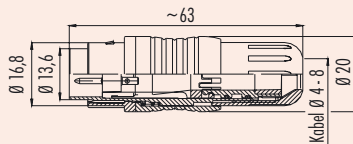

Bestell-Nr.
Ordering-No.

Polzahl Contacts	Bestell-Nr. Ordering-No.
3 DIN	99-4805-00-03
4	99-4809-00-04
5	99-4813-00-05
6 DIN	99-4817-00-06
7	99-4825-00-07
8 DIN	99-4829-00-08
12	99-4833-00-12
14	99-4837-00-14
19	99-4841-00-19

Polzahl Contacts	Bestell-Nr. Ordering-No.
3 DIN	99-4806-00-03
4	99-4810-00-04
5	99-4814-00-05
6 DIN	99-4818-00-06
7	99-4826-00-07
8 DIN	99-4830-00-08
12	99-4834-00-12
14	99-4838-00-14
19	99-4842-00-19

Technische Daten Specifications

Polzahl	3 DIN	4	5	6 DIN	7	8 DIN	12	14	19	Number of contacts	
Steckverbinder Verriegelung	Push-Pull/Push-Pull									Connector locking system	
Anschlussart	löten/solder									Termination	
Anschlussquerschnitt	max. 0,75 mm ² (max. AWG 20)						max. 0,25 mm ² (max. AWG 24)			Wire gauge	
Kabeldurchlass	4-8 mm									Cable outlet	
Schutzart	IP67									Degree of protection	
Mechanische Lebensdauer	> 1000 Steckzyklen/> 1000 mating cycles									Mechanical operation	
Obere Grenztemperatur	+ 85 °C									Upper temperature	
Untere Grenztemperatur	- 25 °C									Lower temperature	
Bemessungsspannung	250 V (32 V)			125 V (32 V)			60 V (32 V)			Rated voltage	
Bemessungsstoßspannung	1500 V			800 V			500 V			Rated impulse voltage	
Verschmutzungsgrad	1 (2) ¹⁾									Pollution degree	
Überspannungskategorie	I (II) ¹⁾									Overvoltage category	
Isolierstoffgruppe	III									Material group	
Bemessungsstrom (40°C)	7 A	6 A			5 A			3 A			Rated current (40 °C)
Durchgangswiderstand	≤ 3 mΩ									Contact resistance	
Material Kontakt	Stift/pin CuZn (Messing/brass), Buchse/socket CuSn (Bronze/bronze)									Material of contact	
Kontaktoberfläche	Au (Gold/gold)									Contact plating	
Material Kontaktkörper	PBT (UL 94 V-0)									Material of contact body	
Material Gehäuse	PA GF 25 (UL 94 V-0)									Material of housing	

Miniatursteckverbinder Serie 440
Miniature connectors series 440
Montageanleitung
Assembly instruction

1. Abmanteln auf L = 33mm.
Ummantelung nicht abstreifen.
2. Druckschraube und Klemmvorrichtung auffädeln. Ummantelung entfernen.
3. Litzen abisolieren und verzinnen.
4. Abschirmung auffächern und auskämmen. Die Abschirmlitzen in der Krone rundum einfädeln.
5. Abstandshülse und Klemmvorrichtung verrasten.
6. Gesteckte Einheit nach hinten übers Kabel schieben (ca. 10mm).
7. Einsätze anlöten.
8. Gesteckte Einheit nach vorne schieben bis sie in den Kontakteinsatz einrastet.
9. Abschirmlitzen in Richtung Abschirmung abstreifen und kürzen.
zu lang: Litzen auf Dichtring - undicht
zu kurz: kein Kontakt zu Wellenring
10. Montierte Einheit in Trägerhülse stecken und Druckschraube festziehen.

1. Strip to 33mm length but do not take off cable jacket.
2. Bead pressing screw and clamp device. Remove cable jacket.
3. Strip the insulation off the wires and tin them.
4. Fanning and comb out sheath of shielding. Thread wires around top.
5. Lock distance sleeve and clamp device.
6. Push mated units backwards over cable (appr. 10mm).
7. Solder inserts.
8. Push mated units forward until snap-in to contact insert.
9. Strip wires towards shield ring and shorten.
too long: wires on seal ring - not tight
too short: no contact to wave ring
10. Mate assembled unit into carrier sleeve and tighten pressing screw.

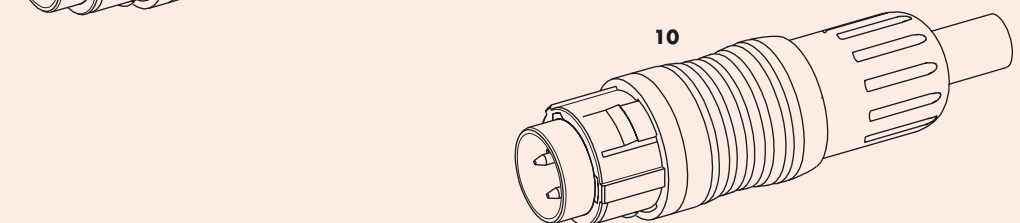
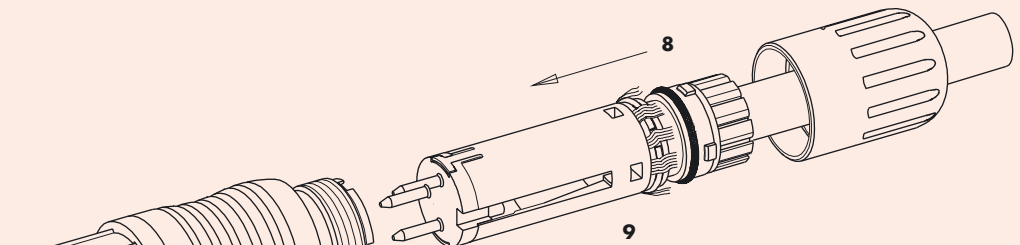
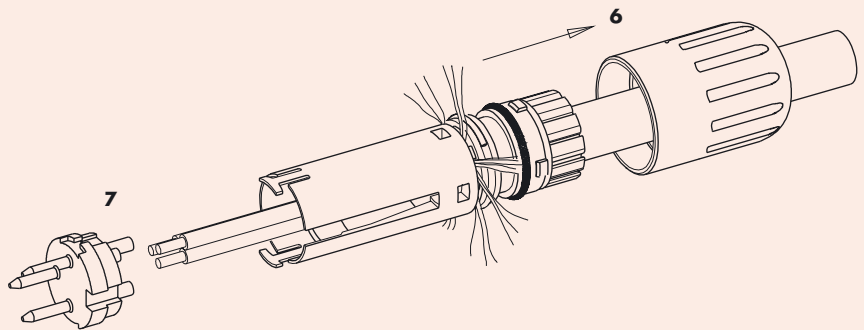
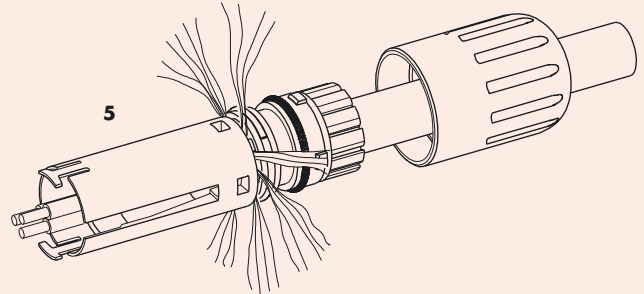
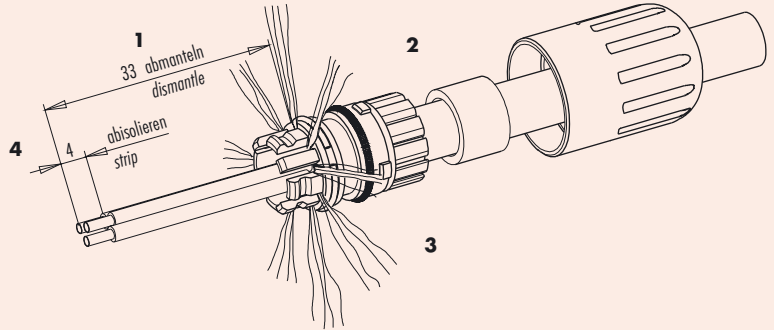

Miniatursteckverbinder Serie 440
Miniature connectors series 440

Einzelteildarstellung
 Component part drawing

Kabelsteckverbinder
 Cable connectors

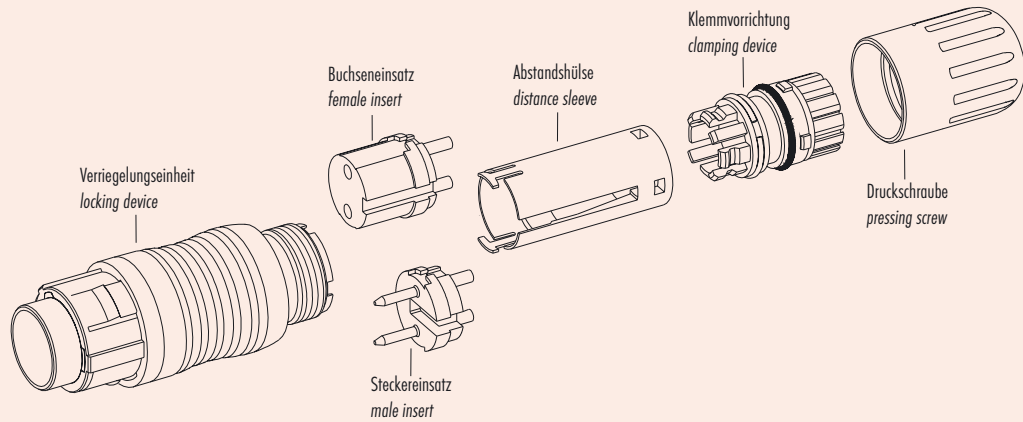

Flanschsteckverbinder
 Socket connectors

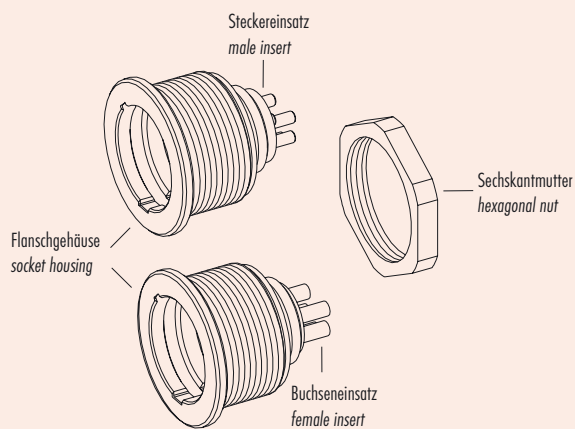

Miniatursteckverbinder Serie 440
Miniature connectors series 440

 Polbilder
 Contact arrangements

 Stifteinsatz (Steckseite)
 Male insert (mating side)

 Buchseneinsatz (Steckseite)
 Female insert (mating side)

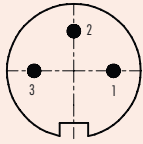
 3 pol (DIN 41524)
 3 contacts (DIN 41524)

	X	Y
1	3,50	0,00
2	0,00	3,50
3	-3,50	0,00

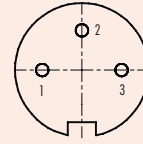

	X	Y
1	-3,50	0,00
2	0,00	3,50
3	3,50	0,00

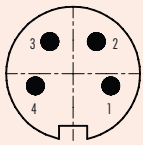
 4 pol
 4 contacts

	X	Y
1	3,32	-1,08
2	2,05	2,83
3	-2,05	2,83
4	-3,32	-1,08

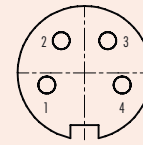

	X	Y
1	-3,32	-1,08
2	-2,05	2,83
3	2,05	2,83
4	3,32	-1,08

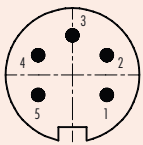
 5 pol
 5 contacts

	X	Y
1	3,03	-1,75
2	3,03	1,75
3	0,00	3,50
4	-3,03	1,75
5	-3,03	-1,75

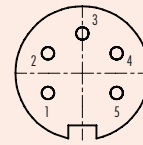

	X	Y
1	-3,03	-1,75
2	-3,03	1,75
3	0,00	3,50
4	3,03	1,75
5	3,03	-1,75

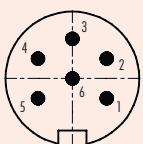
 6 pol
 6 contacts

	X	Y
1	3,03	-1,75
2	3,03	1,75
3	0,00	3,50
4	-3,03	1,75
5	-3,03	-1,75
6	0,00	0,00

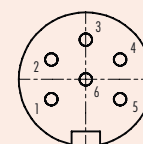

	X	Y
1	-3,03	-1,75
2	-3,03	1,75
3	0,00	3,50
4	3,03	1,75
5	3,03	-1,75
6	0,00	0,00

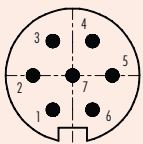
 7 pol
 7 contacts

	X	Y
1	-1,75	-3,03
2	-3,50	0,00
3	-1,75	3,03
4	1,75	3,03
5	3,50	0,00
6	1,75	-3,03
7	0,00	0,00

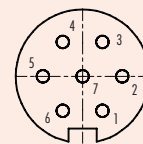

	X	Y
1	1,75	-3,03
2	3,50	0,00
3	1,75	3,03
4	-1,75	3,03
5	-3,50	0,00
6	-1,75	-3,03
7	0,00	0,00

Miniatursteckverbinder Serie 440 Miniature connectors series 440

Polbilder
Contact arrangements

Stifteinsatz (Steckseite)
Male insert (mating side)

Buchseinsatz (Steckseite)
Female insert (mating side)

8 pol (DIN 45326)
8 contacts (DIN 45326)

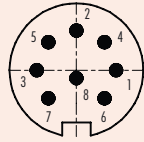

	X	Y
1	3,50	0,00
2	0,00	3,50
3	-3,50	0,00
4	2,47	2,47
5	-2,47	2,47
6	2,47	-2,47
7	-2,47	-2,47
8	0,00	-0,70

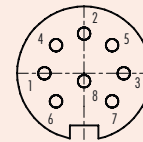

	X	Y
1	-3,50	0,00
2	0,00	3,50
3	3,50	0,00
4	-2,47	2,47
5	2,47	2,47
6	-2,47	-2,47
7	2,47	-2,47
8	0,00	-0,70

12 pol
12 contacts

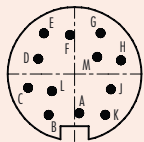

	X	Y
A	0,41	-3,45
B	-2,29	-3,61
C	-4,10	-1,21
D	-3,20	1,34
E	-2,71	3,59
F	-0,41	3,45
G	2,29	3,61
H	4,10	1,21
J	3,20	-1,34
K	2,71	-3,59
L	-2,00	-1,51
M	2,00	1,51

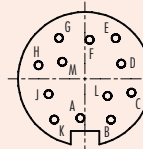

	X	Y
A	-0,41	-3,45
B	2,29	-3,61
C	4,10	-1,21
D	3,20	1,34
E	2,71	3,59
F	0,41	3,45
G	-2,29	3,61
H	-4,10	1,21
J	-3,20	-1,34
K	-2,71	-3,59
L	-2,00	-1,51
M	2,00	1,51

14 pol
14 contacts

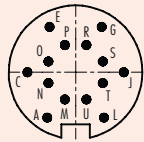

	X	Y
A	-2,50	-4,00
C	-4,25	0,00
E	-2,30	4,00
G	2,30	4,00
J	4,25	0,00
L	2,50	4,00
M	-0,95	-2,40
N	-2,40	-0,95
O	-2,40	0,95
P	-0,95	2,40
R	0,95	2,40
S	2,40	0,95
T	2,40	-0,95
U	0,95	-2,40

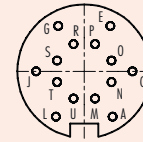

	X	Y
A	2,50	-4,00
C	4,25	0,00
E	2,30	4,00
G	-2,30	4,00
J	-4,25	0,00
L	-2,50	4,00
M	0,95	-2,40
N	2,40	-0,95
O	2,40	0,95
P	0,95	2,40
R	-0,95	2,40
S	-2,40	0,95
T	-2,40	-0,95
U	-0,95	-2,40

19 pol
19 contacts

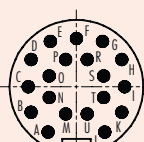

	X	Y
A	-2,50	-4,00
B	-4,00	-2,25
C	-4,25	0,00
D	-4,00	2,40
E	-2,30	4,00
F	0,00	4,25
G	2,30	4,00
H	4,00	2,40
I	4,25	0,00
K	4,00	-2,25
L	2,50	-4,00
M	-0,95	-2,40
N	-2,40	-0,95
O	-2,40	0,95
P	-0,95	2,40
R	0,95	2,40
S	2,40	0,95
T	2,40	-0,95
U	0,95	-2,40

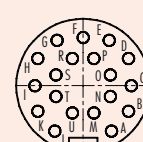

	X	Y
A	2,50	-4,00
B	4,00	-2,25
C	4,25	0,00
D	4,00	2,40
E	2,30	4,00
F	0,00	4,25
G	-2,30	4,00
H	-4,00	2,40
I	-4,25	0,00
K	-4,00	-2,25
L	-2,50	-4,00
M	0,95	-2,40
N	2,40	-0,95
O	2,40	0,95
P	0,95	2,40
R	-0,95	2,40
S	-2,40	0,95
T	-2,40	-0,95
U	-0,95	-2,40

Montageausschnitt
Panel cut out

