

Crimp Attachment for Flexible Cable and Direct Solder for Semi-Rigid Cable

Right Angle Crimp Plug - Miniature Cable

P.N.	Cable Group	Plt.	Ins.	Imp.	Crimp Tool
MCX1112A1-NT30G-1-50	01	Nickel	Teflon	50	3
MCX1112A1-3GT30G-1-50	01	Gold	Teflon	50	3
MCX1112A1-NT30G-1A-50	01A	Nickel	Teflon	50	4
MCX1112A1-3GT30G-1A-50	01A	Gold	Teflon	50	4
MCX1112A1-NT30G-5-50	05	Nickel	Teflon	50	1
MCX1112A1-3GT30G-5-50	05	Gold	Teflon	50	1
MCX1112A1-NT30G-5A-50	05A	Nickel	Teflon	50	2
MCX1112A1-3GT30G-5A-50	05A	Gold	Teflon	50	2
MCX1112A1-NT30G-6-75	06	Nickel	Teflon	75	1
MCX1112A1-3GT30G-6-75	06	Gold	Teflon	75	1
MCX1112A1-NT30G-6A-75	06A	Nickel	Teflon	75	2
MCX1112A1-3GT30G-6A-75	06A	Gold	Teflon	75	2
MCX1112A1-NT30G-14-50	14	Nickel	Teflon	50	1
MCX1112A1-3GT30G-14-50	14	Gold	Teflon	50	1

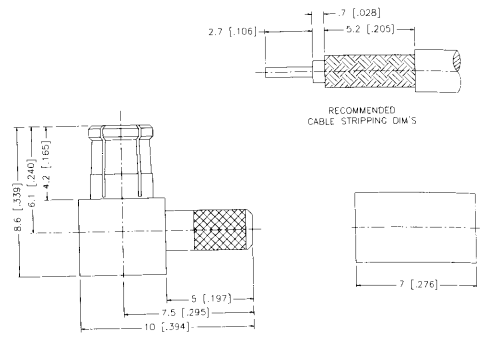
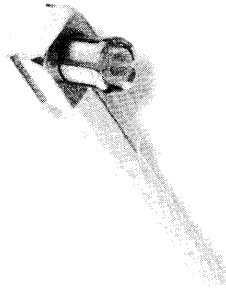

Assembly Instruction I - page 217

Right Angle Solder Plug - Semi-Rigid Cable

P.N.	Cable Group	Plt.	Ins.	Imp.	Crimp Tool
MCX1182A1-NT30G-10-50	10	Nickel	Teflon	50	N/A
MCX1182A1-3GT30G-10-50	10	Gold	Teflon	50	N/A
MCX1182A1-NT30G-11-50	11	Nickel	Teflon	50	N/A
MCX1182A1-3GT30G-11-50	11	Gold	Teflon	50	N/A
MCX1182A1-3GT30G-13-50	13	Gold	Teflon	50	N/A

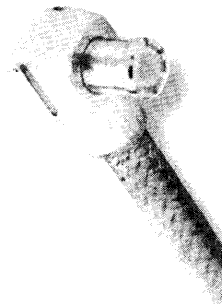

MCX1182A1-NT30G-10-50 & MCX1182A1-3GT30G-10-50

MCX1182A1-NT30G-11-50 & MCX1182A1-3GT30G-11-50

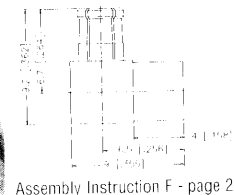
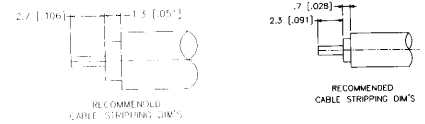

MCX1182A1-3GT30G-13-50

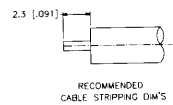

Assembly Instruction F - page 214

Straight Crimp Jack - Miniature Cable

P.N.	Cable Group	Plt.	Ins.	Imp.	Crimp Tool
MCX6121A1-NT30G-5-50	05	Nickel	Teflon	50	1
MCX6121A1-3GT30G-5-50	05	Gold	Teflon	50	1
MCX6121A1-NT30G-5A-50	05A	Nickel	Teflon	50	2
MCX6121A1-3GT30G-5A-50	05A	Gold	Teflon	50	2
MCX6121A1-NT30G-14-50	14	Nickel	Teflon	50	1
MCX6121A1-3GT30G-14-50	14	Gold	Teflon	50	1
MCX6121A1-NT30G-6-75	06	Nickel	Teflon	75	1
MCX6121A1-3GT30G-6-75	06	Gold	Teflon	75	1
MCX6121A1-NT30G-6A-75	06A	Nickel	Teflon	75	2
MCX6121A1-3GT30G-6A-75	06A	Gold	Teflon	75	2

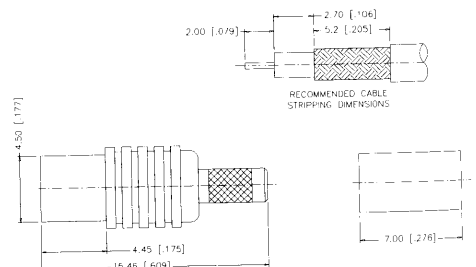
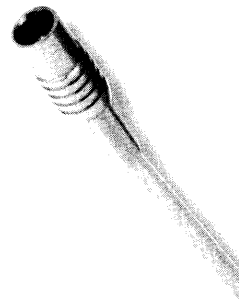

Assembly Instruction J - page 218