

MODEL CUB5V - MINIATURE ELECTRONIC 5-DIGIT DC VOLTMETER



- FOUR SELECTABLE D.C. RANGES
0 to 200 mV, 2 V, 20 V, 200 V
- MINIMUM AND MAXIMUM DISPLAY CAPTURE
- LCD, REFLECTIVE OR RED/GREEN LED BACKLIGHTING
- 0.48" (12.2 mm) HIGH DIGITS
- OPTIONAL SETPOINT OUTPUT CARDS
- OPTIONAL SERIAL COMMUNICATIONS CARDS (RS232 or RS485)
- OPTIONAL USB PROGRAMMING CARD
- OPERATES FROM 9 TO 28 VDC POWER SOURCE
- FRONT PANEL OR CRIMSON PROGRAMMABLE
- DISPLAY COLOR CHANGE CAPABILITY AT SETPOINT OUTPUT
- NEMA 4X/IP65 SEALED FRONT BEZEL

GENERAL DESCRIPTION

The CUB5 provides the user the ultimate in flexibility, from its complete user programming to the optional setpoint control and communication capability. The CUB5V accepts a DC Voltage input signal and provides a display in the desired unit of measure. The meter also features minimum and maximum display capture, display offset, units indicator, and programmable user input. The display can be toggled either manually or automatically between the selected displays.

The CUB5 display has 0.48" (12.2 mm) high digits. The LCD is available in two versions, reflective and red/green backlight. The backlight version is user selectable for the desired color and also has variable display intensity.

The capability of the CUB5 can be easily expanded with the addition of option cards. Setpoint capability is field installable with the addition of the setpoint output cards. Serial communications capability for RS232 or RS485 is added with a serial option card.

The CUB5 can be powered from an optional Red Lion Micro-Line/Sensor Power Supply (MLPS), which attaches directly to the back of a CUB5. The MLPS is powered from 85 to 250 VAC and provides up to 400 mA to drive the unit and sensors.

VOLTAGE

The CUB5V is the DC Volt meter. It features 4 voltage input ranges, that are selected by the user via a programming jumper and software input range selection. The ranges consist of following: 0 to 200 mV, 2 V, 20 V, 200 V. Users should select the appropriate voltage range that covers their maximum input.

SAFETY SUMMARY

All safety related regulations, local codes and instructions that appear in this literature or on equipment must be observed to ensure personal safety and to prevent damage to either the instrument or equipment connected to it. If equipment is used in a manner not specified by the manufacturer, the protection provided by the equipment may be impaired.

Do not use this meter to directly command motors, valves, or other actuators not equipped with safeguards. To do so can be potentially harmful to persons or equipment in the event of a fault to the meter.



CAUTION: Risk of Danger.
 Read complete instructions prior to installation and operation of the unit.



CAUTION: Risk of electric shock.

DIMENSIONS In inches (mm)

Note: Recommended minimum clearance (behind the panel) for mounting clip installation is 2.15" (54.6) H x 3.00" (76.2) W.

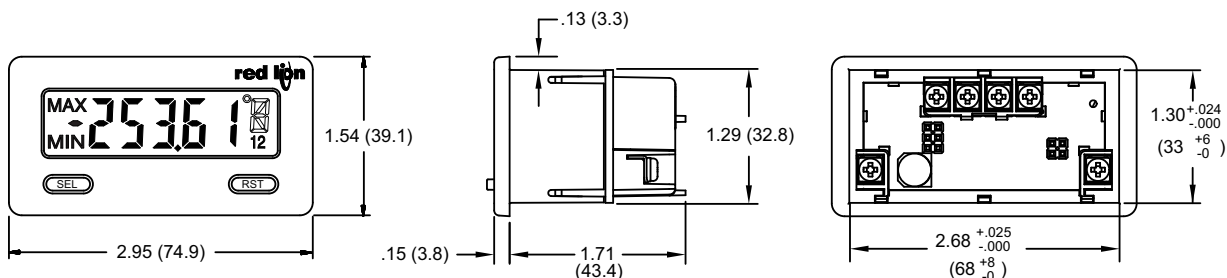

ORDERING INFORMATION

TYPE	MODEL NO.	DESCRIPTION	PART NUMBER
CUB5	CUB5V	DC Volt Meter with reflective display	CUB5VR00
		DC Volt Meter with backlight display	CUB5VB00
Optional Plug-in Cards	CUB5RLY	Single Relay Option Card	CUB5RLY0
	CUB5SNK	Dual Sinking Open Collector Output card	CUB5SNK0
	CUB5COM	RS485 Serial Communications Card	CUB5COM1
		RS232 Serial Communications Card	CUB5COM2
CUB5USB	USB Programming Card	CUB5USB0	
Accessories	MLPS	+12 VDC Micro-Line Power Supply, 85 to 250 VAC source, 400 mA max out	MLPS1000
		+24 VDC Micro-Line Power Supply, 85 to 250 VAC source, 200 mA max out	MLPS2000
	CBLPRO	Programming Cable RS232 (RJ11-DB9)	CBLPROG0
	CBPRO	Programming Cable RS485 (RJ11-DB9)	CBPRO007
	SFCRD	Crimson 2 PC Configuration Software for Windows 98, ME, 2000, XP ¹	SFCRD200
	CBLUSB	USB Programming Cable	CBLUSB00

¹ Crimson software is a free download from <http://www.redlion.net/>

GENERAL METER SPECIFICATIONS

- DISPLAY:** 5 digit LCD 0.48" (12.2 mm) high digits
CUB5VR00: Reflective LCD with full viewing angle
CUB5VB00: Transmissive LCD with selectable red or green LED backlight, viewing angle optimized. Display color change capability with output state when using an output module.
- POWER:** Input voltage range is +9 to +28 VDC with short circuit and input polarity protection.

MODEL NO.	DISPLAY COLOR	INPUT CURRENT @ 9 VDC WITHOUT CUB5RLY0	INPUT CURRENT @ 9 VDC WITH CUB5RLY0
CUB5VR00	---	10 mA	40 mA
CUB5VB00	Red (max intensity)	85 mA	115 mA
CUB5VB00	Green (max intensity)	95 mA	125 mA

- INPUT RANGES:** Jumper Selectable
D.C. Voltages: 200 mV, 2 V, 20 V, 200 V
- SIGNAL INPUTS:**

INPUT RANGE	ACCURACY @23 °C, less than 85% RH	INPUT IMPEDANCE	MAX INPUT SIGNAL	RESOLUTION	TEMP. COEFFICIENT
200 mVDC	0.1% of span	1.027 MΩ	75 VDC	10 μV	70 ppm / °C
2 VDC	0.1% of span	1.027 MΩ	75 VDC	.1 mV	70 ppm / °C
20 VDC	0.1% of span	1.027 MΩ	250 VDC	1 mV	70 ppm / °C
200 VDC	0.1% of span	1.027 MΩ	250 VDC	10 mV	70 ppm / °C

- OVERRANGE RATINGS, PROTECTION & INDICATION:**
9 to 28 VDC power circuit is not isolated from the signal circuit.
Input Overrange Indication: "OLOL"
Input Underrange Indication: "ULUL"
Display Overrange/Underrange Indication: "....."/"-....."
- A/D CONVERTER:** 16 bit resolution
- RESPONSE TIME:**
Display: 500 msec min.
Output: 800 msec max (with input filter setting of 0)
- NORMAL MODE REJECTION:** 60 dB 50/60 Hz
- USER INPUT (USR):** Programmable input. Connect terminal to common (USR COMM) to activate function. Internal 10KΩ pull-up resistor to +9 to 28 VDC.
Threshold Levels: $V_{IL} = 1.0$ V max; $V_{IH} = 2.4$ V min; $V_{MAX} = 28$ VDC
Response Time: 5 msec typ.; 50 msec debounce (activation and release)
- CONNECTIONS:** Wire clamping screw terminals
Wire Strip Length: 0.3" (7.5 mm)
Wire Gauge: 30-14 AWG copper wire
Torque: 5 inch-lbs (0.565 N-m) max.
- MEMORY:** Nonvolatile E²PROM memory retains all programming parameters and max/min values when power is removed.
- CONSTRUCTION:** This unit is rated for NEMA 4X/IP65 requirements for outdoor use. Installation Category I, Pollution Degree 2. High impact plastic case with clear viewing window. Panel gasket and mounting clip included.
- ENVIRONMENTAL CONDITIONS:**

Operating Temperature Range for CUB5VR00: -35 to 75°C
Operating Temperature Range for CUB5VB00 depends on display color and intensity level as per below:

	INTENSITY LEVEL	TEMPERATURE
Red Display	1 & 2	-35 to 75°C
	3	-35 to 70°C
	4	-35 to 60°C
	5	-35 to 50°C

	INTENSITY LEVEL	TEMPERATURE
Green Display	1 & 2	-35 to 75°C
	3	-35 to 65°C
	4	-35 to 50°C
	5	-35 to 35°C

- Storage Temperature:** -35 to 85°C
Operating and Storage Humidity: 0 to 85% max. relative humidity (non-condensing)
Vibration According to IEC 68-2-6: Operational 5 to 500 Hz, in X, Y, Z direction for 1.5 hours, 5 g's.
Shock According to IEC 68-2-27: Operational 30 g, 11 msec in 3 directions.
Altitude: Up to 2000 meters

14. CERTIFICATIONS AND COMPLIANCES:

SAFETY

- UL Recognized Component, File #E179259, UL61010-1, CSA C22.2 No. 61010-1
Recognized to U.S. and Canadian requirements under the Component Recognition Program of Underwriters Laboratories, Inc.
UL Listed, File # E137808, UL508, CSA C22.2 No. 14-M95
LISTED by Und. Lab. Inc. to U.S. and Canadian safety standards
Type 4X Outdoor Enclosure rating (Face only), UL50
IECEE CB Scheme Test Report #E179259-V01-S02
Issued by Underwriters Laboratories, Inc.
IEC 61010-1, EN 61010-1: Safety requirements for electrical equipment for measurement, control, and laboratory use, Part 1.
IP65 Enclosure rating (Face only), IEC 529

ELECTROMAGNETIC COMPATIBILITY

- Emissions and Immunity to EN 61326: Electrical Equipment for Measurement, Control and Laboratory use.

Immunity to Industrial Locations:

Electrostatic discharge	EN 61000-4-2	Criterion A 4 kV contact discharge 8 kV air discharge
Electromagnetic RF fields	EN 61000-4-3	Criterion A 10 V/m
Fast transients (burst)	EN 61000-4-4	Criterion A 2 kV power 1 kV signal
Surge	EN 61000-4-5	Criterion A 1 kV L-L, 2 kV L&N-E power
RF conducted interference	EN 61000-4-6	Criterion A 3 V/rms
Power frequency magnetic fields	EN 61000-4-8	Criterion A 30 A/m

Emissions:

- Emissions EN 55011 Class A

Notes:

1. *Criterion A: Normal operation within specified limits.*

15. **WEIGHT:** 3.2 oz (100 g)

OPTIONAL PLUG-IN CARDS

ADDING OPTION CARDS

The CUB5 meters can be fitted with optional output cards and/or serial communications cards. The details for the plug-in cards can be reviewed in the specification section below. The plug-in cards, that are sold separately, can be installed initially or at a later date.



WARNING: Disconnect all power to the unit before installing Plug-in card.

Note: Measurement errors may occur if signal input common is shared with another circuit common (ie, serial common, Dual Sinking Output option card, or Power Supply common) on multiple units.

SINGLE RELAY CARD

Type: Single FORM-C relay
Isolation To Sensor & User Input Commons: 1400 Vrms for 1 min.
Working Voltage: 150 Vrms
Contact Rating: 1 amp @ 30 VDC resistive; 0.3 amp @ 125 VAC resistive
Life Expectancy: 100,000 minimum operations

DUAL SINKING OUTPUT CARD

Type: Non-isolated switched DC, N Channel open drain MOSFET
Current Rating: 100 mA max.

V_{DS ON}: 0.7 V @ 100 mA
V_{DS MAX}: 30 VDC
Offstate Leakage Current: 0.5 mA max.

RS485 SERIAL COMMUNICATIONS CARD

Type: RS485 multi-point balanced interface (non-isolated)
Baud Rate: 300 to 38.4k
Data Format: 7/8 bits; odd, even, or no parity
Bus Address: 0 to 99; max 32 meters per line
Transmit Delay: Selectable (refer to CUB5COM bulletin)

RS232 SERIAL COMMUNICATIONS CARD

Type: RS232 half duplex (non-isolated)
Baud Rate: 300 to 38.4k
Data Format: 7/8 bits; odd, even, or no parity

USB PROGRAMMING CARD

Type: USB virtual comms port
Connection: Type B
Baud Rate: 300 to 38.4k
Unit Address: 0 to 99

1.0 INSTALLING THE METER

INSTALLATION

The meter meets NEMA 4X/IP65 requirements when properly installed. The unit is intended to be mounted into an enclosed panel. Prepare the panel cutout to the dimensions shown. Remove the panel latch from the unit. Slide the panel gasket over the rear of the unit to the back of the bezel. The unit should be installed fully assembled. Insert the unit into the panel cutout.

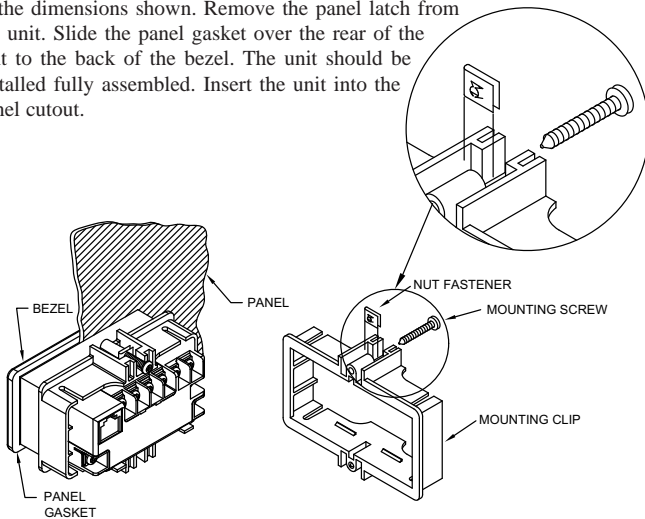

While holding the unit in place, push the panel latch over the rear of the unit so that the tabs of the panel latch engage in the slots on the case. The panel latch should be engaged in the farthest forward slot possible. To achieve a proper seal, tighten the latch screws evenly until the unit is snug in the panel (Torque to approx. 28 to 36 in-oz [0.202 to 0.26 N-m]). Do not over-tighten the screws.

INSTALLATION ENVIRONMENT

The unit should be installed in a location that does not exceed the operating temperature and provides good air circulation. Placing the unit near devices that generate excessive heat should be avoided.

The bezel should only be cleaned with a soft cloth and neutral soap product. Do NOT use solvents. Continuous exposure to direct sunlight may accelerate the aging process of the bezel.

Do not use tools of any kind (screwdrivers, pens, pencils, etc.) to operate the keypad of the unit.

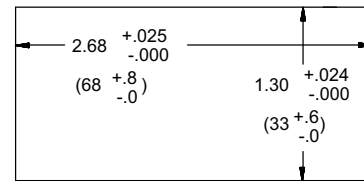

2.0 SETTING THE JUMPERS

INPUT RANGE JUMPER

This jumper is used to select the proper input range. The input range selected in programming must match the jumper setting. Select a range that is high enough to accommodate the maximum input to avoid overloads. To access the jumper, remove the rear cover of the meter.



Warning: Exposed line voltage exists on the circuit boards. Remove all power to the meter and load circuits before accessing inside of the meter.

REMOVING THE REAR COVER

To remove the rear cover, locate the cover locking tab below the 2nd and 3rd input terminals. To release the tab, insert a small, flat blade screwdriver between the tab and the plastic wall below the terminals. Inserting the screwdriver will provide enough pressure to release the tab locks. To replace the cover, align the cover with the input terminals and press down until the cover snaps into place.

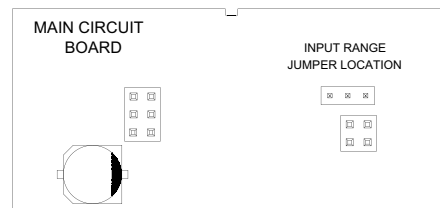
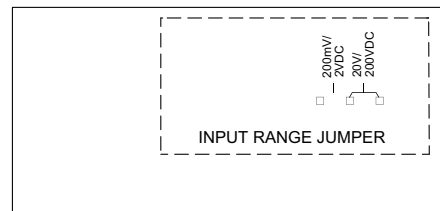

3.0 INSTALLING PLUG-IN CARDS

The Plug-in cards are separately purchased option cards that perform specific functions. The cards plug into the main circuit board of the meter.

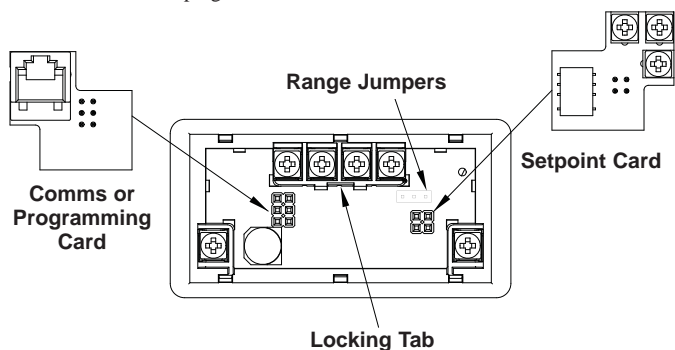

CAUTION: The Plug-in cards and main circuit board contain static sensitive components. Before handling the cards, discharge static charges from your body by touching a grounded bare metal object. Ideally, handle the cards at a static controlled clean workstation. Also, only handle the cards by the edges. Dirt, oil or other contaminants that may contact the cards can adversely affect circuit operation.

REMOVING THE REAR COVER

To remove the rear cover, locate the cover locking tab below the 2nd and 3rd input terminals. To release the tab, insert a small, flat blade screwdriver between the tab and the plastic wall below the terminals. Inserting the screwdriver will provide enough pressure to release the tab locks. To replace the cover, align the cover with the input terminals and press down until the cover snaps into place.

4.0 WIRING THE METER

WIRING OVERVIEW

Electrical connections are made via screw-clamp terminals located on the back of the meter. All conductors should conform to the meter's voltage and current ratings. All cabling should conform to appropriate standards of good installation, local codes and regulations. It is recommended that the power supplied to the meter (DC or AC) be protected by a fuse or circuit breaker.

Strip the wire, leaving approximately 0.3" (7.5 mm) bare lead exposed (stranded wires should be tinned with solder.) Insert the lead under the correct screw-clamp terminal and tighten until the wire is secure. (Pull wire to verify tightness.) Each terminal can accept up to one #14 AWG (2.55 mm) wire, two #18 AWG (1.02 mm), or four #20 AWG (0.61 mm).

EMC INSTALLATION GUIDELINES

Although this meter is designed with a high degree of immunity to Electro-Magnetic Interference (EMI), proper installation and wiring methods must be followed to ensure compatibility in each application. The type of the electrical noise, source or coupling method into the meter may be different for various installations. The meter becomes more immune to EMI with fewer I/O connections. Cable length, routing, and shield termination are very important and can mean the difference between a successful or troublesome installation. Listed below are some EMC guidelines for successful installation in an industrial environment.

1. The meter should be mounted in a metal enclosure, which is properly connected to protective earth.
2. Use shielded (screened) cables for all Signal and Control inputs. The shield (screen) pigtail connection should be made as short as possible. The connection point for the shield depends somewhat upon the application. Listed below are the recommended methods of connecting the shield, in order of their effectiveness.
 - a. Connect the shield only at the panel where the unit is mounted to earth ground (protective earth).
 - b. Connect the shield to earth ground at both ends of the cable, usually when the noise source frequency is above 1 MHz.

4.1 POWER WIRING

DC Power

+9 to +28 VDC: +VDC
Power Common: -VDC

CAUTION: 9 to 28 VDC power circuit is not isolated from the signal circuit.

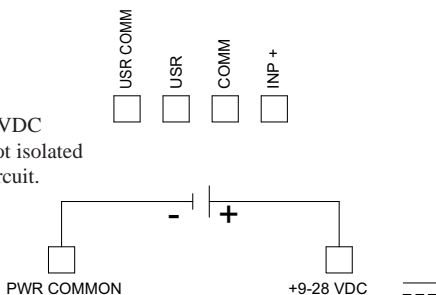

- c. Connect the shield to common of the meter and leave the other end of the shield unconnected and insulated from earth ground.
3. Never run Signal or Control cables in the same conduit or raceway with AC power lines, conductors feeding motors, solenoids, SCR controls, and heaters, etc. The cables should be ran in metal conduit that is properly grounded. This is especially useful in applications where cable runs are long and portable two-way radios are used in close proximity or if the installation is near a commercial radio transmitter.
4. Signal or Control cables within an enclosure should be routed as far as possible from contactors, control relays, transformers, and other noisy components.
5. In extremely high EMI environments, the use of external EMI suppression devices, such as ferrite suppression cores, is effective. Install them on Signal and Control cables as close to the unit as possible. Loop the cable through the core several times or use multiple cores on each cable for additional protection. Install line filters on the power input cable to the unit to suppress power line interference. Install them near the power entry point of the enclosure. The following EMI suppression devices (or equivalent) are recommended:
 - Ferrite Suppression Cores for signal and control cables:
 - Fair-Rite # 0443167251 (RLC# FCOR0000)
 - TDK # ZCAT3035-1330A
 - Steward # 28B2029-0A0
 - Line Filters for input power cables:
 - Schaffner # FN610-1/07 (RLC# LFIL0000)
 - Schaffner # FN670-1.8/07
 - Corcom # 1 VR3

Note: Reference manufacturer's instructions when installing a line filter.
6. Long cable runs are more susceptible to EMI pickup than short cable runs. Therefore, keep cable runs as short as possible.
7. Switching of inductive loads produces high EMI. Use of snubbers across inductive loads suppresses EMI.
 - Snubber: RLC# SNUB0000.

4.2 USER INPUT WIRING

Sinking Logic

USR COMM } Connect external switching device between the
USR } User Input terminal and User Input Common.

The user input of the meter is internally pulled up to +9 to +28 V with 10 K resistance. The input is active when it is pulled low (<0.7 V).

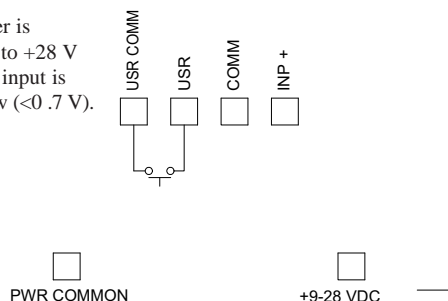

4.3 INPUT WIRING



CAUTION: Power input common is NOT isolated from user and input commons. In order to preserve the safety of the meter application, the power input common must be suitably isolated from hazardous live earth referenced voltage; or input common must be at protective earth ground potential. If not, hazardous voltage may be present at the signal or user inputs and input common terminals. Appropriate considerations must then be given to the potential of the user and input commons with respect to earth ground; and the common of the plug-in cards with respect to input common.

Before connecting signal wires, the Input Range Jumper should be verified for proper position.

Voltage Signal (self powered)

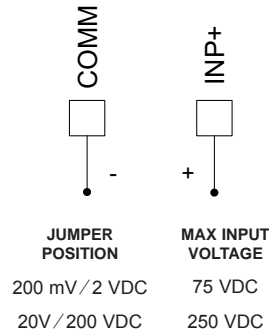

4.4 SETPOINT (OUTPUT) WIRING

SINGLE SETPOINT RELAY PLUG-IN CARD

ELECTRICAL CONNECTIONS

DUAL SETPOINT N-FET OPEN DRAIN PLUG-IN CARD

ELECTRICAL CONNECTIONS

Output Common is not isolated from DC Power Common. Load must be wired between OSNK terminal and V+ of the load supply.

4.5 SERIAL COMMUNICATION WIRING

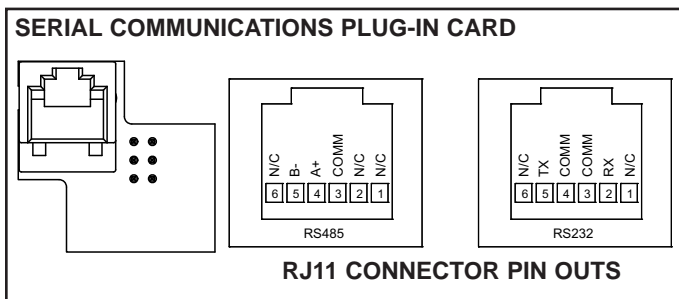

4.6 USB PROGRAMMING

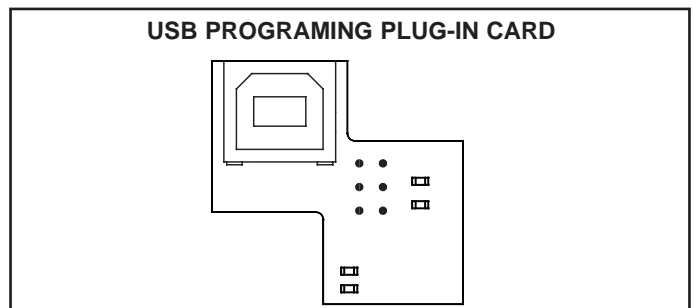

5.0 REVIEWING THE FRONT BUTTONS AND DISPLAY

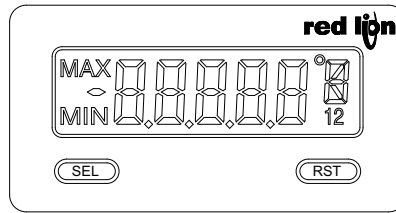

BUTTON	DISPLAY MODE OPERATION	ENTERING PROGRAM MODE	PROGRAMMING MODE OPERATION
SEL	Index display through enabled values	Press and hold for 2 seconds to activate	Store selected parameter and index to next parameter
RST	Resets values (MIN/MAX) or outputs		Advances through the program menu Increments selected parameter value or selection

OPERATING MODE DISPLAY DESIGNATORS

MAX - Maximum display capture value
MIN - Minimum display capture value

"1" - To the right of the display indicates setpoint 1 output activated.
"2" - To the right of the display indicates setpoint 2 output activated.

Pressing the **SEL** button toggles the meter through the selected displays. If display scroll is enabled, the display will toggle automatically every four seconds between the enabled display values.

6.0 PROGRAMMING THE METER

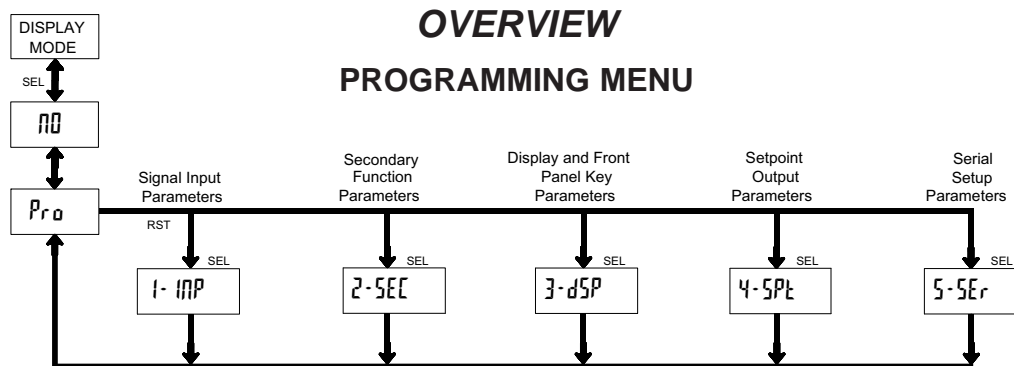

PROGRAMMING MODE ENTRY (SEL BUTTON)

It is recommended all programming changes be made off line, or before installation. The meter normally operates in the Display Mode. No parameters can be programmed in this mode. The Programming Mode is entered by pressing and holding the **SEL** button. If it is not accessible then it is locked by either a security code, or a hardware lock.

MODULE ENTRY (SEL & RST BUTTONS)

The Programming Menu is organized into separate modules. These modules group together parameters that are related in function. The display will alternate between **Pr0** and the present module. The **RST** button is used to select the desired module. The displayed module is entered by pressing the **SEL** button.

MODULE MENU (SEL BUTTON)

Each module has a separate module menu (which is shown at the start of each module discussion). The **SEL** button is pressed to advance to a particular parameter to be changed, without changing the programming of preceding parameters. After completing a module, the display will return to **Pr0 n0**. Programming may continue by accessing additional modules.

SELECTION / VALUE ENTRY

For each parameter, the display alternates between the present parameter and the selections/value for that parameter. The **RST** button is used to move through the selections/values for that parameter. Pressing the **SEL** button, stores and activates the displayed selection/value. This also advances the meter to the next parameter.

For numeric values, press the **RST** button to access the value. The right hand most digit will begin to flash. Pressing the **RST** button again increments the digit by one or the user can hold the **RST** button and the digit will automatically scroll. The **SEL** button will advance to the next digit. Pressing and holding the **SEL** button will enter the value and move to the next parameter.

PROGRAMMING MODE EXIT (SEL BUTTON)

The Programming Mode is exited by pressing the **SEL** button with **Pr0 n0** displayed. This will commit any stored parameter changes to memory and return the meter to the Display Mode. (If power loss occurs before returning to the Display Mode, verify recent parameter changes.)

PROGRAMMING TIPS

It is recommended to start with Module 1 and proceed through each module in sequence. When programming is complete, it is recommended to record the parameter programming and lock out parameter programming with the user input or programming security code.

FACTORY SETTINGS

Factory Settings may be completely restored in Module 2. This is useful when encountering programming problems.

ALTERNATING SELECTION DISPLAY

In the explanation of the modules, the following dual display with arrows will appear. This is used to illustrate the display alternating between the parameter on top and the parameter's Factory Setting on the bottom. In most cases, selections and values for the parameter will be listed on the right.

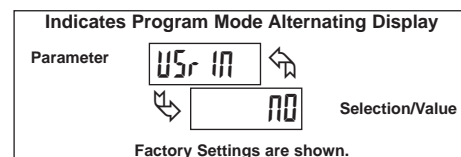

6.1 MODULE 1 - SIGNAL INPUT PARAMETERS (I- INP)

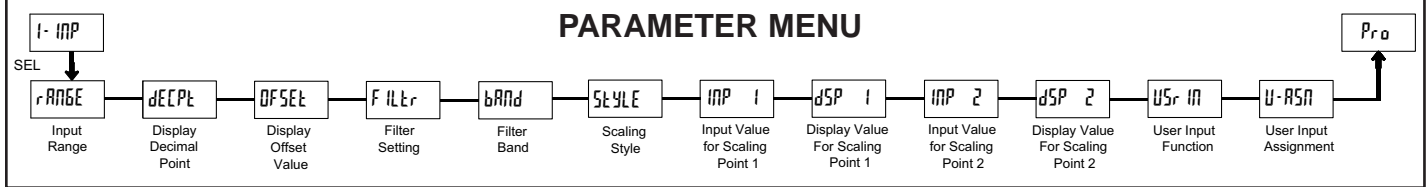

CUB5V INPUT RANGE

SELECTION	RANGE	RESOLUTION	SELECTION	RANGE	RESOLUTION
0.2u	200.00	mV	20u	20.000	V
2u	2.0000	V	200u	200.00	V

Select the input range that corresponds to the external signal. This selection should be high enough to avoid input signal overload but low enough for the desired input resolution. This selection and the position of the Input Range Jumper must match.

DISPLAY DECIMAL POINT

SELECTION	0	00	000	0000	00000
0					

Select the decimal point location for the Input, MIN and MAX displays. This selection also affects the dSP 1 and dSP 2 parameters and setpoint values.

DISPLAY OFFSET VALUE

SELECTION	- 19999	to 19999
0.00		

The display can be corrected with an offset value. This can be used to compensate for signal variations or sensor errors. This value is automatically updated after a Zero Display to show how far the display is offset. A value of zero will remove the effects of offset.

FILTER SETTING

SELECTION	0	1	2	3
1				

If the displayed value is difficult to read due to small process variations or noise, increased levels of filtering will help to stabilize the display. Software filtering effectively combines a fraction of the current input reading with a fraction of the previous displayed reading to generate the new display.

Filter values represent no filtering (0), up to heavy filtering (3). A value of 1 for the filter uses 1/4 of the new input and 3/4 of the previous display to generate the new display. A filter value of 2 uses 1/8 new and 7/8 previous. A filter value of 3 uses 1/16 new and 15/16 previous.

FILTER BAND

SELECTION	0	to 199	display units
10			

The filter will adapt to variations in the input signal. When the variation exceeds the input filter band value, the filter disengages. When the variation becomes less than the band value, the filter engages again. This allows for a stable readout, but permits the display to settle rapidly after a large process change. The value of the band is in display units, independent of the Display Decimal Point position. A band setting of '0' keeps the filter permanently engaged at the filter level selected above.

SCALING STYLE

SELECTION	KEY	APLY
KEY		

If Input Values and corresponding Display Values are known, the Key-in (KEY) scaling style can be used. This allows scaling without the presence or changing of the input signal. If Input Values have to be derived from the actual input signal source or simulator, the Apply (APLY) scaling style must be used.

INPUT VALUE FOR SCALING POINT 1

SELECTION	0	to 29999
0.00		

For Key-in (KEY) style, enter the first Input Value using the front panel buttons. (The Input Range selection sets the decimal location for the Input Value).

For Apply (APLY) style, the meter shows the previously stored Input Value. To retain this value, press the SEL button to advance to the next parameter. To change the Input Value, press the RST button and apply the input signal to the meter. Adjust the signal source externally until the desired Input Value appears. Press the SEL button to enter the value being displayed.

DISPLAY VALUE FOR SCALING POINT 1

SELECTION	- 19999	to 99999
0.00		

Enter the first Display Value by using the front panel buttons. This is the same for KEY and APLY scaling styles. The decimal point follows the dECPt selection.

INPUT VALUE FOR SCALING POINT 2

SELECTION	0	to 29999
100.00		

For Key-in (KEY) style, enter the known second Input Value using the front panel buttons.

For Apply (APLY) style, the meter shows the previously stored Input Value for Scaling Point 2. To retain this value, press the SEL button to advance to the next parameter. To change the Input Value, press the RST button and apply the input signal to the meter. Adjust the signal source externally until the desired Input Value appears. Press the SEL button to enter the value being displayed.

DISPLAY VALUE FOR SCALING POINT 2

SELECTION	- 19999	to 99999
100.00		

Enter the second Display Value by using the front panel buttons. This is the same for KEY and APLY scaling styles.

General Notes on Scaling

- When using the Apply (APLY) scaling style, input values for scaling points must be confined to the signal input limits of the selected range.
- The same Input Value should not correspond to more than one Display Value. (Example: 10 V can not equal 0 and 10.)
- For input levels beyond the programmed Input Values, the meter extends the Display Value by calculating the slope from the two coordinate pairs (INP 1 / dSP 1 & INP 2 / dSP 2).

USER INPUT FUNCTION

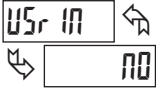

DISPLAY	MODE	DESCRIPTION
NO	No Function	User Input disabled.
P-Loc	Program Mode Lock-out	See Programming Mode Access chart (Module 3).
ZE-0	Zero Input (Edge triggered)	Zero the Input Display value causing Display Reading to be Offset.
rESEt	Reset (Edge triggered)	Resets the assigned value(s) to the current input value.
d-Hld	Display Hold	Holds the assigned display, but all other meter functions continue as long as activated (maintained action).
d-SEL	Display Select (Edge Triggered)	Advance once for each activation.
d-LEV	Display Intensity Level (Edge Triggered)	Increase intensity one level for each activation (backlight version only).
COLOr	Backlight Color (Edge Triggered)	Change backlight color with each activation (backlight version only).

DISPLAY	MODE	DESCRIPTION
Pr in t	Print Request	Serial transmit of the active parameters selected in the Print Options menu (Module 5).
P-r 5t	Print and Reset	Same as Print Request followed by a momentary reset of the assigned value(s).
r 5t - 1	Setpoint 1 Reset	Resets setpoint 1 output.
r 5t - 2	Setpoint 2 Reset	Resets setpoint 2 output.
r 5t 12	Setpoint 1 and 2 Reset	Reset both setpoint 1 and 2 outputs.

USER INPUT ASSIGNMENT

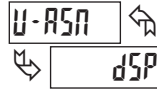

HI HI-LO
LO dSP

Select the value(s) to which the User Input Function is assigned. The User Input Assignment only applies if a selection of reset, display hold, or print and reset is selected in the User Input Function menu.

6.2 MODULE 2 - SECONDARY FUNCTION PARAMETERS (2-5EE)

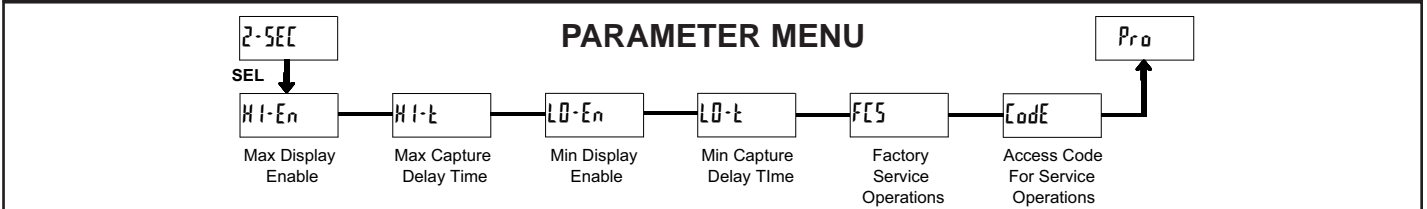

MAX DISPLAY ENABLE

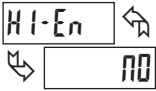

NO YES

Enables the Maximum Display Capture capability.

MAX CAPTURE DELAY TIME

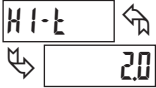

00 to 9999 seconds

When the Input Display is above the present MAX value for the entered delay time, the meter will capture that display value as the new MAX reading. A delay time helps to avoid false captures of sudden short spikes.

MIN DISPLAY ENABLE

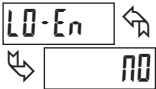

NO YES

Enables the Minimum Display Capture capability.

MIN CAPTURE DELAY TIME

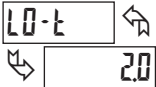

00 to 9999 seconds

When the Input Display is below the present MIN value for the entered delay time, the meter will capture that display value as the new MIN reading. A delay time helps to avoid false captures of sudden short spikes.

FACTORY SERVICE OPERATIONS

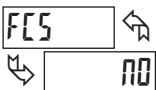

NO YES

Select YES to perform either of the Factory Service Operations shown below.

RESTORE FACTORY DEFAULT SETTINGS



Entering Code 66 will overwrite all user settings with the factory settings. The meter will display rESEt and then return to CodE 00. Press the SEL button to exit the module.

VIEW VERSION DISPLAY



Entering Code 50 will display the version (x.x) of the meter. The display then returns to CodE 00. Press the SEL button to exit the module.

CALIBRATION



The CUB5V uses stored voltage calibration values to provide accurate voltage measurements. Over time, the electrical characteristics of the components inside the meter will slowly change, with the result that the stored calibration values no longer accurately define the input circuit. For most applications, recalibration every 1 to 2 years should be sufficient.

Calibration of the CUB5V involves an input voltage calibration, which should only be performed by individuals experienced in calibrating electronic equipment. Allow a 30 minute warm up before performing any calibration related procedures. The following procedures should be performed at an ambient temperature of 15 to 35°C (59 to 95°F).

CAUTION: The accuracy of the calibration equipment will directly affect the accuracy of the CUB5V.

Voltage Calibration

1. Connect a precision DC voltage source with an accuracy of 0.01% or better to the INP+ (positive) and COMM (negative) terminals of the CUB5V. Set the output of the voltage source to zero.
2. With the display at CodE 48, press and hold the SEL button for 2 seconds. Unit will display rRL 00.
3. Press the RST button to select the range to be calibrated.
4. Press the SEL button. Display reads 00.
5. With the voltage source set to zero (or a dead short applied to the input), press SEL. Display reads rRL for about 8 seconds.
6. When the display reads the selected range, apply full-scale input signal for the range. (Note: For 200V range, apply 100V as indicated on the display.) Press SEL. Display reads rRL for about 8 seconds.
7. Repeat steps 3 through 6 for each input range to be calibrated. When display reads rRL 00, press the SEL button to exit calibration.

6.3 MODULE 3 - DISPLAY AND FRONT PANEL BUTTON PARAMETERS (3-d5P)

PARAMETER MENU

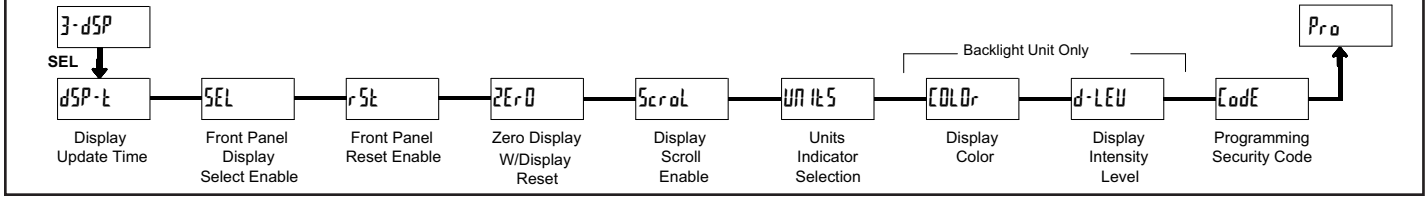

DISPLAY UPDATE TIME



This parameter sets the display update time in seconds.

DISPLAY COLOR (BACKLIGHT UNIT ONLY)



Enter the desired display color, red or green. This parameter is active for backlight units only.

FRONT PANEL DISPLAY SELECT ENABLE (SEL)



The YES selection allows the SEL button to toggle through the enabled displays.

DISPLAY INTENSITY LEVEL (BACKLIGHT UNIT ONLY)



Enter the desired Display Intensity Level (1-5). The display will actively dim or brighten as levels are changed. This parameter is active for backlight units only.

FRONT PANEL RESET ENABLE (RST)



This selection allows the RST button to reset the selected value(s).

PROGRAMMING SECURITY CODE



The Security Code determines the programming mode and the accessibility of programming parameters. This code can be used along with the Program Mode Lock-out (P-Loc) in the User Input Function parameter (Module 1).

Two programming modes are available. Full Programming mode allows all parameters to be viewed and modified. Quick Programming mode permits only the Setpoint values to be modified, but allows direct access to these values without having to enter Full Programming mode.

Programming a Security Code other than 0, requires this code to be entered at the CodE prompt in order to access Full Programming mode. Depending on the code value, Quick Programming may be accessible before the CodE prompt appears (see chart).

ZERO DISPLAY WITH DISPLAY RESET



This parameter enables the RST button or user input to zero the input display value, causing the display reading to be offset.

Note: For this parameter to operate, the RST button or User Input being used must be set to d5P and the Input value must be displayed. If these conditions are not met, the display will not zero.

DISPLAY SCROLL ENABLE



The YES selection allows the display to automatically scroll through the enabled displays. The scroll rate is every 4 seconds. This parameter only appears when the MAX or MIN displays are enabled.

UNITS INDICATOR SELECTION



This parameter activates the Units Indicator on the display. There are two methods of selecting the Indicator. List will present a group of Units preprogrammed into the meter. Segments allows the user to choose which of the segments should light.

USER INPUT FUNCTION	USER INPUT STATE	SECURITY CODE	MODE WHEN "SEL" BUTTON IS PRESSED	FULL PROGRAMMING MODE ACCESS
not P-Loc	---	0	Full Programming	Immediate Access
		1-99	Quick Programming	After Quick Programming with correct code entry at CodE prompt *
		100-999	CodE prompt	With correct code entry at CodE prompt *
P-Loc	Active	0	Programming Lock	No Access
		1-99	Quick Programming	No Access
		100-999	CodE prompt	With correct code entry at CodE prompt *
	Not Active	0-999	Full Programming	Immediate Access

* Entering Code 222 allows access regardless of security code.

6.4 MODULE 4 - SETPOINT OUTPUT PARAMETERS (4-SPt)

PARAMETER MENU

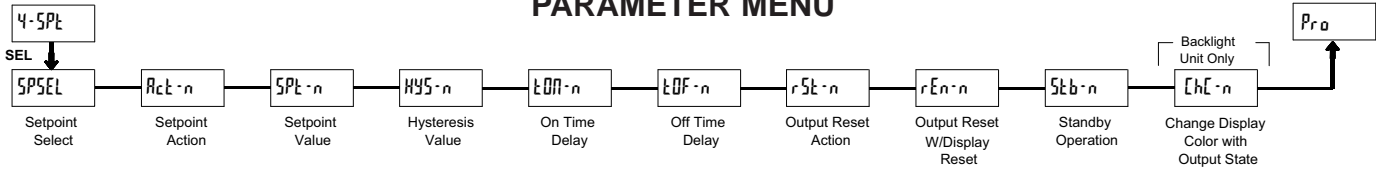

The Setpoint Output Parameters are only active when an optional output module is installed in the meter.

SETPOINT SELECT

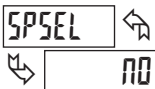

n0 SP-1 SP-2

Enter the setpoint (output) to be programmed. The *n* in the following parameters will reflect the chosen setpoint number. After the chosen setpoint is completely programmed, the display will return to SPSEL. Repeat steps for each setpoint to be programmed. Select n0 to exit the module. The number of setpoints available is setpoint output card dependent.

SETPOINT 2 ENABLE

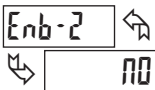

YES n0

Select YES to enable Setpoint 2 and access the setup parameters. If n0 is selected, the unit returns to SPSEL and setpoint 2 is disabled.

SETPOINT ACTION

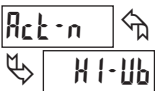

H1-bL L0-bL H1-Ub L0-Ub

Enter the action for the selected setpoint (output). See Setpoint Output Figures for a visual detail of each action.

- H1-bL = High Acting, with balanced hysteresis
- L0-bL = Low Acting, with balanced hysteresis
- H1-Ub = High Acting, with unbalanced hysteresis
- L0-Ub = Low Acting, with unbalanced hysteresis

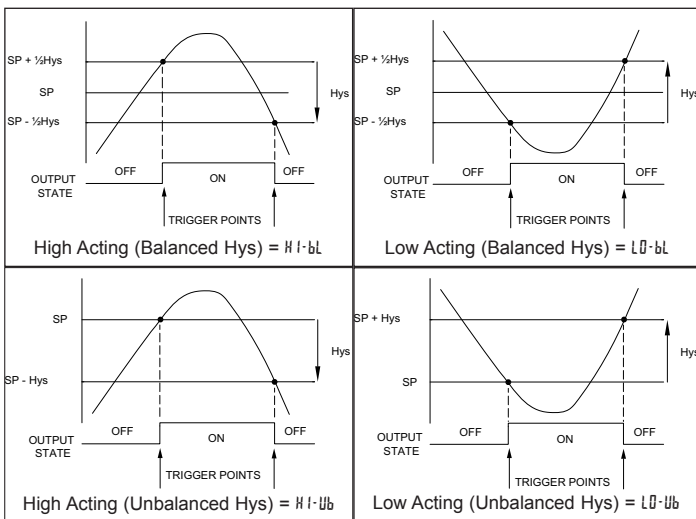

SETPOINT VALUE

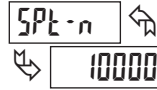

. 99999 to 99999

Enter the desired setpoint value. The decimal point position for the setpoint and hysteresis values follow the selection set in Module 1.

HYSTERESIS VALUE

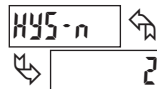

1 to 99999

Enter desired hysteresis value. See Setpoint Output Figures for visual explanation of how setpoint output actions (balanced and unbalanced) are affected by the hysteresis. When the setpoint is a control output, usually balanced hysteresis is used. For alarm applications, usually unbalanced hysteresis is used. For unbalanced hysteresis modes, the hysteresis functions on the low side for high acting setpoints and functions on the high side for low acting setpoints.

Note: Hysteresis eliminates output chatter at the switch point, while time delay can be used to prevent false triggering during process transient events.

ON TIME DELAY

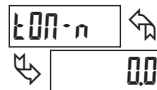

0.0 to 9999 seconds

Enter the time value in seconds that the output is delayed from turning on after the trigger point is reached. A value of 0.0 allows the meter to update the output status per the response time listed in the Specifications.

OFF TIME DELAY

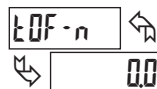

0.0 to 9999 seconds

Enter the time value in seconds that the output is delayed from turning off after the trigger point is reached. A value of 0.0 allows the meter to update the output status per the response time listed in the Specifications.

OUTPUT RESET ACTION

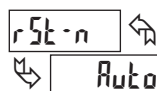

Auto LATCH L-dLY

Enter the reset action of the output. See figure for details.

Auto = Automatic action; This action allows the output to automatically reset off at the trigger points per the Setpoint Action shown in Setpoint Output Figures. The "on" output may be manually reset (off) immediately by the front panel RST button or user input. The output remains off until the trigger point is crossed again.

LATCH = Latch with immediate reset action; This action latches the output on at the trigger point per the Setpoint Action shown in Setpoint Output Figures. Latch means that the output can only be turned off by the front panel RST

button or user input manual reset, serial reset command or meter power cycle. When the user input or **RST** button is activated (momentary action), the corresponding “on” output is reset immediately and remains off until the trigger point is crossed again. (Previously latched alarms will be off if power up Display Value is lower than setpoint value.)

L-dLY = Latch with delay reset action; This action latches the output on at the trigger point per the Setpoint Action shown in Setpoint Output Figures. Latch means that the output can only be turned off by the front panel **RST** button or user input manual reset, serial reset command or meter power cycle. When the user input or **RST** button is activated (momentary action), the meter delays the event until the corresponding “on” output crosses the trigger off point. (Previously latched outputs are off if power up Display Value is lower than setpoint value. During a power cycle, the meter erases a previous **L-dLY** reset if it is not activated at power up.)

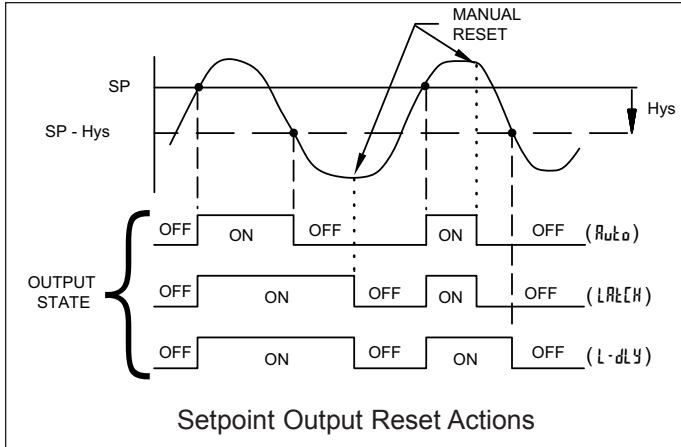

OUTPUT RESET WITH DISPLAY RESET



This parameter enables the **RST** button or user input to reset the output when the display is reset.

Note: For this parameter to operate, the **RST** button or User Input being used must be set to **dSP** and the Input value must be displayed. If these conditions are not met, the output will not reset.

STANDBY OPERATION



When **YES**, the output is disabled (after a power up) until the trigger point is crossed. Once the output is on, the output operates normally per the Setpoint Action and Output Reset Action.

CHANGE DISPLAY COLOR w/OUTPUT STATE



This parameter enables the backlight CUB5 to switch the backlight color when the output state changes. This parameter is only active for the backlight version.

6.5 MODULE 5 - SERIAL SETUP PARAMETERS (5-5Er)

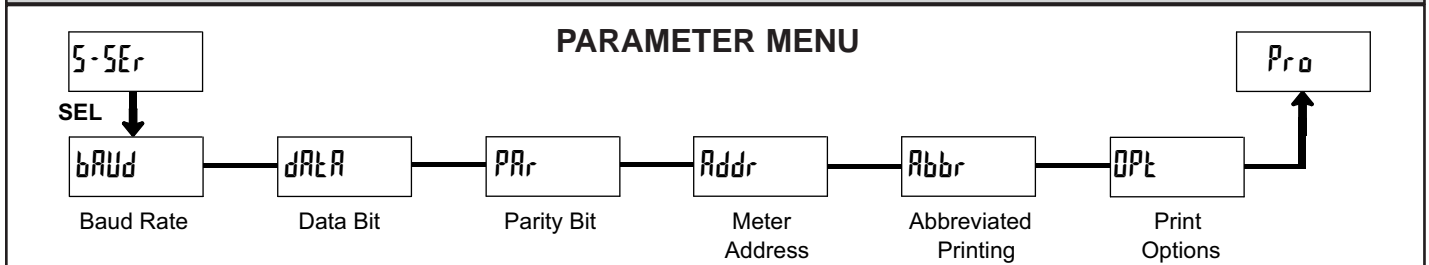

The Serial Setup Parameters are only active when one of the optional serial communication/programming cards is installed in the meter.

Refer to the CUB5COM bulletin for details on CUB5 RS232 or RS485 serial communications.

Refer to the CUB5USB bulletin for details on the CUB5 USB programming and programming requirements.

LIMITED WARRANTY

The Company warrants the products it manufactures against defects in materials and workmanship for a period limited to two years from the date of shipment, provided the products have been stored, handled, installed, and used under proper conditions. The Company's liability under this limited warranty shall extend only to the repair or replacement of a defective product, at The Company's option. The Company disclaims all liability for any affirmation, promise or representation with respect to the products.

The customer agrees to hold Red Lion Controls harmless from, defend, and indemnify RLC against damages, claims, and expenses arising out of subsequent sales of RLC products or products containing components manufactured by RLC and based upon personal injuries, deaths, property damage, lost profits, and other matters which Buyer, its employees, or sub-contractors are or may be to any extent liable, including without limitation penalties imposed by the Consumer Product Safety Act (P.L. 92-573) and liability imposed upon any person pursuant to the Magnuson-Moss Warranty Act (P.L. 93-637), as now in effect or as amended hereafter.

No warranties expressed or implied are created with respect to The Company's products except those expressly contained herein. The Customer acknowledges the disclaimers and limitations contained herein and relies on no other warranties or affirmations.

CUB5V PROGRAMMING QUICK OVERVIEW

Press and hold **SEL** button to enter Programming Mode.

