

- 1 **Wide range of types and sizes**
- 1 **Rugged and durable**
- 1 **Suitable for use under extreme conditions of pressure and temperature**
- 1 **Ideal for most general industrial applications**

**Technical Data**

Medium:

Compressed air*.

*Consult our Technical Service for use with other fluids.

Operating Pressure:

The maximum working pressure is limited by the type of tubing being used. Refer to Section 9.12 for details.

Operating Temperature:

The maximum working temperature is limited by the type of tubing being used. Refer to Section 9.12 for details.

Tube Sizes:

4, 5, 6, 8, 10, 12, 15, 16, 18, 22, 28 mm O/D.

Tubing:

Nylon 11 or 12 and other plasticised or unplasticised tubing which conforms to the tolerances specified in BS 5409: Part 1 1976.

Copper, annealed and half-hard to BS 2871: Part 2.

Double wall brazed steel.

Materials

Brass to BS 2874: 1986 (CZ121) for tubing nut, sleeve and body manufactured from bar. Brass to BS 2872: 1969 (CZ122) for body manufactured from stamping. Banjo bolts have a bright nickel plated finish.

Ordering Information



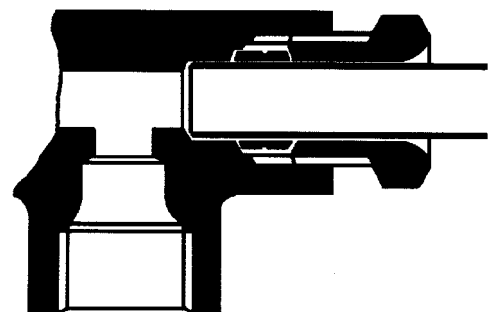







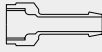











To order, quote appropriate product number from the tables on the following pages.













Compression Fittings Metric











Straight Connectors and Adaptors

STEM TAILPIECE ADAPTOR Tube stem to hose 36 0524  Page 9.6.001.06	FEMALE TAILPIECE ADAPTOR Tube to hose 36 0522  Page 9.6.001.06	STRAIGHT STEM ADAPTOR Tube stem to male parallel BSP thread 36 0521  Page 9.6.001.06	STRAIGHT STEM ADAPTOR Tube stem to male taper BSP thread 36 0531  Page 9.6.001.07	NIPPLED STEM CONNECTOR Male tube to tube stem 36 0625  Page 9.6.001.07	REDUCING CONNECTOR Female tube to male tube 36 0517  Page 9.6.001.07	BULKHEAD CONNECTOR Female tube 36 0508  Page 9.6.001.07
NIPPLED CONNECTOR Male tube 36 0632  Page 9.6.001.08	MALE CONNECTOR Male to male 36 0737  Page 9.6.001.08	UNEQUAL CONNECTOR Female tube to male tube 36 0562  Page 9.6.001.08	STRAIGHT CONNECTOR Female tube 36 0503  Page 9.6.001.08	BRACKETED STRAIGHT CONNECTOR Female tube 36 0552  Page 9.6.001.08	METRIC TO INCH ADAPTOR Male tube to female tube 36 0562  Page 9.6.001.09	NIPPLED ADAPTOR Male tube to metric and UNF female thread 36 0553  Page 9.6.001.09
NIPPLED ADAPTOR Male tube to male taper BSP thread 36 0556  Page 9.6.001.09	NIPPLED ADAPTOR Male tube to female parallel BSP thread 36 0557  Page 9.6.001.09	STRAIGHT MALE ADAPTOR Female tube to male taper BSP thread 36 0530  Page 9.6.001.10	STRAIGHT MALE ADAPTOR (NPTF) Female tube to male NPTF thread 36 0532  Page 9.6.001.10	STRAIGHT MALE ADAPTOR Female tube to male thread 36 0554  Page 9.6.001.10	MALE ADAPTOR 36 0738  Page 9.6.001.10	STRAIGHT MALE ADAPTOR Female tube to male parallel BSP thread 36 0504  Page 9.6.001.10
STRAIGHT ADAPTOR Female tube to female parallel BSP thread 36 0505  Page 9.6.001.11	HOBBS STRAIGHT CONNECTOR Male parallel BSP thread 36 0543  Page 9.6.001.17					

Elbow Connectors and Adaptors



UNIVERSAL STEM ELBOW Tube stem 36 0292  Page 9.6.001.11	STEM ELBOW CONNECTOR Female tube to tube stem 36 0551  Page 9.6.001.11	ELBOW CONNECTOR Female tube 36 0511  Page 9.6.001.12	BRACKETED ELBOW CONNECTOR Female tube 36 0548  Page 9.6.001.12	FEMALE ELBOW ADAPTOR Female tube to female parallel BSP thread 36 0555  Page 9.6.001.12	MALE ELBOW ADAPTOR Female tube to male taper BSP thread 36 0005  Page 9.6.001.13	MALE ELBOW ADAPTOR Female tube to male NPTF thread 36 0331  Page 9.6.001.13
HOBBS ELBOW ADAPTOR Female tube to male parallel BSP thread 36 0541  Page 9.6.001.17						

Tee, 'Y' and Four Way Connectors and Adaptors







STEM TEE CONNECTOR Female tube to tube stem 36 0550  Page 9.6.001.14	90° STEM TEE CONNECTOR Female tube to tube stem 36 0631  Page 9.6.001.14	SIDE STEM TEE CONNECTOR Female tube to tube stem 36 0511  Page 9.6.001.14	TEE CONNECTOR Female tube 36 0514  Page 9.6.001.14	BRACKETED TEE CONNECTOR Female tube 36 0549  Page 9.6.001.15	MALE TEE ADAPTOR Female tube to male taper BSP thread 36 0627  Page 9.6.001.15	MALE SIDE TEE ADAPTOR Female tube to male taper BSP thread 36 0628  Page 9.6.001.15
'Y' CONNECTOR Female tube 36 0558  Page 9.6.001.15	FOUR WAY CONNECTOR Female tube 36 0516  Page 9.6.001.16	HOBBS TEE ADAPTOR Female tube to male parallel BSP thread 36 0542  Page 9.6.001.18				





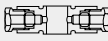

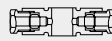







Manifolds

<p>SINGLE SIDED MANIFOLD</p> <p>36 0304</p>  <p>Page 9.6.001.16</p>	<p>DOUBLE SIDED MANIFOLD</p> <p>36 0406</p>  <p>Page 9.6.001.16</p>					
---	---	--	--	--	--	--

Banjos

<p>ELBOW BANJO ASSEMBLY Non regulating BSPP bolt Female tube to male parallel BSP thread</p> <p>36 0395</p>  <p>Page 9.6.001.20</p>	<p>ELBOW BANJO ASSEMBLY Regulating BSPP bolt Female tube to male parallel BSP thread</p> <p>36 0395</p>  <p>Page 9.6.001.20</p>	<p>TEE BANJO ASSEMBLY Non regulating BSPP bolt Female tube to male parallel BSP thread</p> <p>36 0395</p>  <p>Page 9.6.001.20</p>	<p>ELBOW BANJO BODY Tube</p> <p>36 0384</p>  <p>Page 9.6.001.21</p>	<p>TEE BANJO BODY Tube</p> <p>36 0394</p>  <p>Page 9.6.001.21</p>	<p>BANJO BOLTS Regulating</p> <p>36 0461</p>  <p>Page 9.6.001.21</p>	<p>BANJO BOLTS Non-regulating</p> <p>36 0451</p>  <p>Page 9.6.001.21</p>
---	---	---	---	--	--	--

Accessories

<p>FORM CUTTER</p> <p>39 0500</p>  <p>Page 9.6.001.06</p>	<p>TAP</p> <p>39 0501</p>  <p>Page 9.6.001.06</p>	<p>TUBING PLUG Male tube thread</p> <p>36 0509</p>  <p>Page 9.6.001.06</p>	<p>BULKHEAD LOCKNUT</p> <p>36 0520</p>  <p>Page 9.6.001.08</p>	<p>HOBBS CONED LOCKNUT Female parallel BSP thread</p> <p>36 0540</p>  <p>Page 9.6.001.17</p>	<p>HOBBS SEAL Female tube</p> <p>34 0156</p>  <p>Page 9.6.001.17</p>	<p>SEALING WASHERS For use with banjo fitting</p> <p>48 0314</p>  <p>Page 9.6.001.17</p>
<p>UNIVERSAL TUBING SLEEVE</p> <p>36 0501</p>  <p>Page 9.6.001.18</p>	<p>TUBING SLEEVE</p> <p>36 0502</p>  <p>Page 9.6.001.18</p>	<p>TUBING NUT</p> <p>36 0500</p>  <p>Page 9.6.001.18</p>	<p>FOLDED COPPER WASHER</p> <p>48 0213</p>  <p>Page 9.6.001.18</p>	<p>'O' RING SEAL</p> <p>48 0261</p>  <p>Page 9.6.001.18</p>		



Compression Fittings Metric

Assembly Details

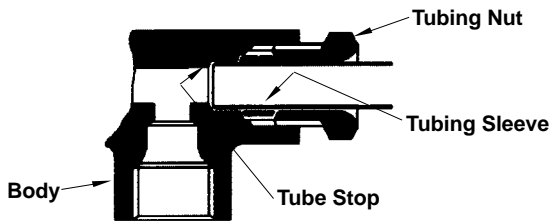

Method of Assembly

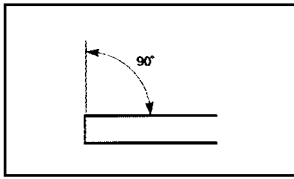

1. Ensure that the tube is cut square and is free from fraze.

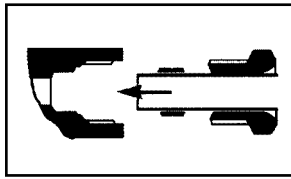

2. Place the tubing nut and sleeve on the tube and push the tube into the fitting until it bottoms on the tube stop.

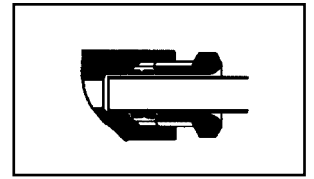

3. Holding the tube firmly in contact with the tube stop screw the tubing nut down finger tight and then tighten a further 1-13/4 full turns. Slacken off the assembly and then pinch down again.

The method of preparation and assembly described will ensure leak-proof joints over a wide pressure range, depending upon the size and type of tubing being used. Failure to follow this guide, or over-tightening at any joint, will only lead to damage of the fittings or an unsatisfactory seal.

Instructions For Machining

Where for some reason, such as saving overall space, it is desired to dispense with the male adaptor and fit a tube, complete with its associated nut and sleeve, direct into a casting, this may be done as illustrated below, by machining the correct form and thread with the appropriate size of form cutter and tap.

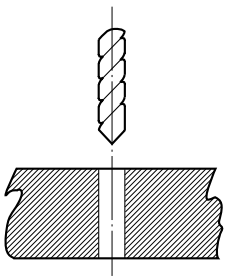

1. DRILL

It is difficult to recommend specific drill sizes to suit our range of form cutters and taps without having detailed knowledge of the material to be machined and details of the particular installation.

As a general rule, however, when preparing for an Enots compression assembly, a drill size of 1 mm less in diameter than the tubing size should be used, up to and including 8 mm tube. For larger tubing, a drill of approximately 2 mm less in diameter is recommended.

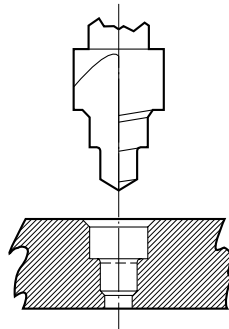

2. FORM

The correct form cutter should be selected from the table overleaf for the outside diameter tubing being used.

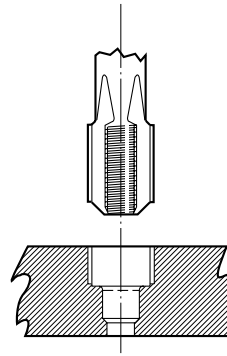

3. TAP

The correct size thread tap should be selected from the table overleaf for the outside diameter tubing being used. Owing to the fine pitch of the threads used, only a plug tap is required.

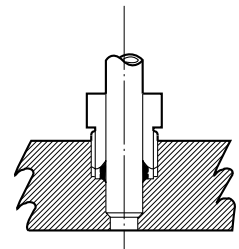

4. ASSEMBLY

The tube, or stem fittings, with appropriate tubing nut and sleeve, can now be assembled into the port.

We can advise on individual problems but we cannot be held responsible for failures due to non-observance of the dimensions and tolerances which we lay down for these compression unions.



Torque Figures

Metric

Recommended torque using 36 0501 00 series sleeves

O.D. tube	Half hard copper	Annealed copper	Nylon 11 & 12	Double Wall Brazed Steel
4	4,5 Nm	3,4 Nm	2,8 Nm	5,7 Nm
5	6,8 Nm	5,7 Nm	5,7 Nm	-
6	9,0 Nm	7,9 Nm	5,7 Nm	10,2 Nm
8	11,3 Nm	7,9 Nm	7,9 Nm	12,4 Nm
10	21,5 Nm	18,1 Nm	13,6 Nm	21,5 Nm
12	24,9 Nm	22,6 Nm	15,8 Nm	27,1 Nm
15	34,0 Nm	28,0 Nm	25,0 Nm	-
16	46,0 Nm	31,0 Nm	26,0 Nm	-
18	52,0 Nm	35,0 Nm	45,0 Nm	-
22	79,0 Nm	68,0 Nm	46,0 Nm	-
28	76,0 Nm	68,0 Nm	96,0 Nm	-

Conversion: Nm x 0,74 = lbf ft

Typical Dimensions

Hose stem to tube with reducing connector

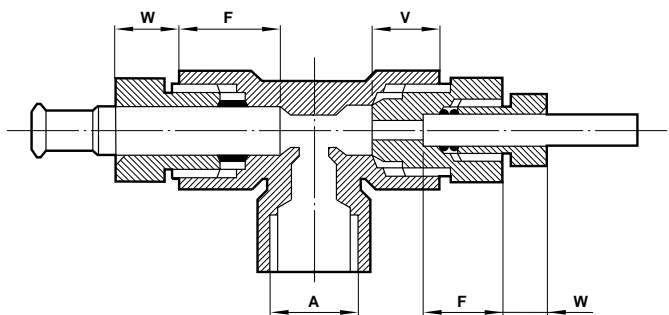

O.D. tube	A thread details	F	V	W
4	M8 x 1,0	10,5	8,3	6,0
5	M10 x 1,0	12,0	9,5	6,5
6	M11 x 1,0	12,0	9,4	7,0
8	M13 x 1,0	15,0	11,7	8,0
10	M15 x 1,0	16,5	12,7	8,0
12	M18 x 1,5	17,0	13,4	9,0
15	M22 x 1,5	18,5	16,0	10,0
16	M24 x 1,5	19,0	16,2	10,5
18	M26 x 1,5	20,0	17,0	10,5
22	M30 x 1,5	24,5	20,5	11,0
28	M38 x 1,5	30,0	25,8	12,5

A = outside diameter tube size and thread details.*

F = tube or stem length inside fitting.

V = nipped connector length inside fitting.

W = projection of tubing nut from compression joint.

All these dimensions are common to a particular tubing outside diameter size. Refer to later pages in this section for details of individual coupling dimensions. Dimensions V & W will vary with the torque applied so these dimensions are guidance only.

*Note: The 'O/D tube' sizes in the following tables refer to the Enots compression threads listed above.



Compression Fittings Metric

Form Cutter

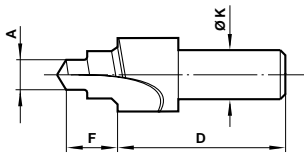

Product number	A O/D tube	D	F	K
39 0500 02	4	48	10,5	12,7
39 0500 03	5	48	12,0	12,7
39 0500 04	6	48	12,0	12,7
39 0500 05	8	48	15,0	12,7
39 0500 06	10	48	16,5	12,7
39 0500 07	12	48	17,0	12,7
39 0500 08	16	48	19,0	20,0
39 0500 10	22	48	24,5	20,0
39 0500 12	28	48	30,0	20,0

Tap

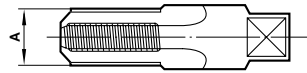

Plug taps only available

Product number	For O/D tube	A thread
39 0501 02	4	M8 x 1,0
39 0501 03	5	M10 x 1,0
39 0501 04	6	M11 x 1,0
39 0501 05	8	M13 x 1,0
39 0501 06	10	M15 x 1,0
39 0501 07	12	M18 x 1,5
39 0501 08	16	M24 x 1,5
39 0501 10	22	M30 x 1,5
39 0501 12	28	M38 x 1,5

Tubing Plug

Male O/D tube thread

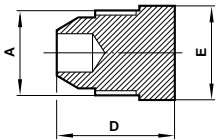

Product number	A O/D tube	D	E A/F
36 0509 02	4	15,3	8
36 0509 03	5	17,0	10
36 0509 04	6	17,0	13
36 0509 05	8	19,5	13
36 0509 06	10	21,0	17
36 0509 07	12	23,5	19
36 0509 15	15	26,5	22
36 0509 08	16	27,0	24
36 0509 18	18	29,0	27
36 0509 10	22	33,5	30
36 0509 12	28	41,5	41

Stem Tailpiece Adaptor

O/D tube stem to hose

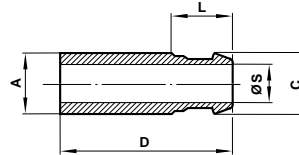

Product number	A O/D tube	C hose stem bore	D	L	S
36 0524 15	4	5,0	36,5	17,5	1,9
36 0524 16	5	5,0	38,5	17,0	2,8
36 0524 24	6	6,3	40,5	17,5	4,3
36 0524 25	8	6,3	43,5	17,5	4,3
36 0524 42	10	10,0	47,0	19,0	7,3
36 0524 43	12	10,0	49,0	19,0	7,3
36 0524 53	16	12,5	54,8	20,0	9,7
36 0524 67	22	19,0	64,7	22,7	15,8
36 0524 83	28	25,0	76,0	24,0	21,5

Female Tailpiece Adaptor

Tube to hose

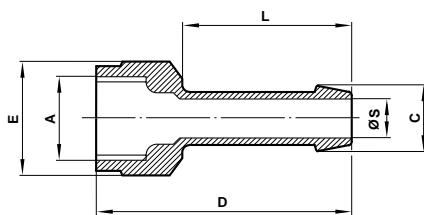

Product number	A O/D tube	C hose bore	D	E A/F	L	S
36 0522 25	8	6,3	37	17	20	5,5
36 0522 43	12	10,0	41	22	22	8,5
36 0522 53	16	12,5	45	27	23	10,5

Straight Stem Adaptor

O/D tube stem to male parallel BSP thread

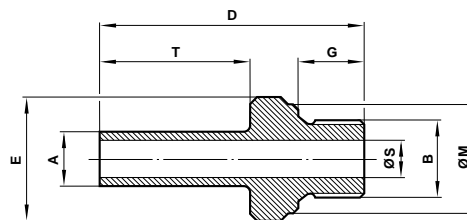

Product number	A O/D stem	B BSPP	D	E A/F	G	M	S	T
36 0521 03	5	1/8"	36	13	7,4	13	3	21
36 0521 05	8	1/8"	40	13	7,4	13	5	26
36 0521 10	6	1/4"	42	19	11,0	18	4	23
36 0521 11	8	1/4"	45	19	11,0	18	5	26
36 0521 20	10	3/8"	49	24	11,4	22	7	28
36 0521 21	12	3/8"	51	24	11,4	22	9	30
36 0521 31	16	1/2"	61	27	15,0	26	12	35
36 0521 47	22	3/4"	71	36	16,3	32	18	42
36 0521 62	28	1"	85	41	19,1	39	23	51

Sealing washers should be ordered separately, see pages 9.6.001.42 – 43.



Straight Stem Adaptor

O/D tube stem to male taper BSP thread

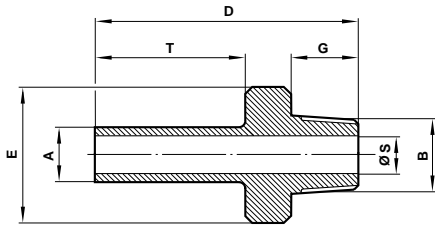

Product number	A O/D stem	B thread BSPP	D	E A/F	G	S	T
36 0531 03	5	1/8"	35	13	9,5	3	21
36 0531 04	6	1/8"	37	13	9,5	4	23
36 0531 05	8	1/8"	40	13	9,5	5	26
36 0531 10	6	1/4"	42	14	11,1	4	23
36 0531 11	8	1/4"	45	14	11,0	5	26
36 0531 12	10	1/4"	47	14	11,1	7	28
36 0531 20	10	3/8"	49	19	12,7	7	28
36 0531 21	12	3/8"	51	19	12,7	9	30

Nippled Stem Connector

Male O/D tube to O/D tube stem

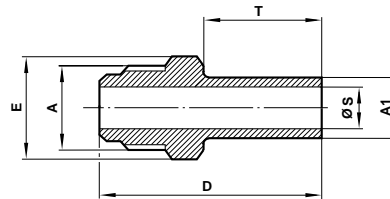

Product number	A1 O/D stem	A O/D tube	D	E A/F	S	T
36 0625 03	5	5	38,0	10,0	3,0	21,0
36 0625 04	6	6	40,0	13,0	4,0	23,0
36 0625 05	8	8	45,5	13,0	5,0	26,0
36 0625 06	10	10	49,0	17,0	7,0	28,0
36 0625 07	12	12	53,5	19,0	9,0	30,0

Reducing Connector

Female O/D tube to male O/D tube

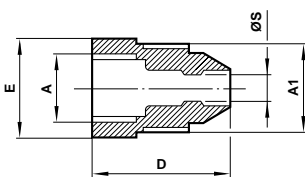

Product number	A1 O/D tube	A O/D tube	D	E A/F	S
36 0517 26	5	4	20,0	10	2,8
36 0517 27	6	4	16,0	13	2,8
36 0517 28	8	4	19,5	13	2,8
36 0517 37	6	5	22,0	13	3,4
36 0517 38	8	5	19,5	13	3,4
36 0517 39	10	5	21,0	17	3,4
36 0517 40	12	5	23,5	19	3,4
36 0517 41	16	5	27,0	24	3,4
36 0517 47	8	6	25,0	13	4,0
36 0517 48	10	6	21,0	17	4,0
36 0517 49	12	6	23,5	19	4,0
37 0517 57	15	6	26,5	22	6,0
36 0517 50	16	6	27,0	24	4,0
36 0517 56	10	8	27,5	17	6,0
36 0517 57	12	8	23,5	19	6,0
36 0517 58	16	8	27,0	24	6,0
36 0517 64	12	10	31,0	19	7,6
37 0517 61	15	10	27,0	22	6,0
36 0517 65	16	10	27,0	24	7,6
36 0517 71	16	12	27,0	24	9,6
36 0517 73	22	12	33,5	30	9,6
36 0517 75	28	12	41,5	41	9,6
36 0517 78	22	16	33,5	30	13,6
36 0517 80	28	16	41,5	41	13,6
36 0517 87	28	22	41,5	41	19,0

Bulkhead Connector

Female O/D tube

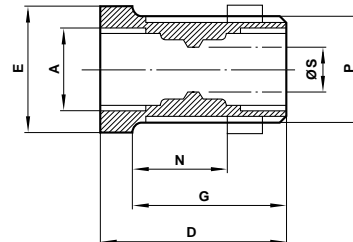

Product number	A O/D tube	D	E A/F	G	N max. bulkhead	P thread	S	Bulkhead clearance drilling	Locknut number
36 0508 02	4	23	17	18	12	M12 x 1,0	2,8	13	36052001
36 0508 03	5	26	19	20	13	M15 x 1,0	3,4	16	36052003
36 0508 04	6	26	19	20	13	M15 x 1,0	4,0	16	36052003
36 0508 05	8	32	22	26	19	M18 x 1,5	6,0	19	36052005
36 0508 06	10	35	24	29	20	M20 x 1,5	7,6	21	36052006
36 0508 07	12	36	30	30	21	M24 x 1,5	9,6	25	36052007
36 0508 08	16	41	36	35	25	M30 x 1,5	13,6	32	36052008
36 0508 10	22	53	46	44	33	M38 x 1,5	19,0	40	36052010
36 0508 12	28	64	55	54	42	M48 x 1,5	25,0	50	36052012

Minimum Bulkhead thickness 3,0.
Locknuts should be ordered separately, see next page.



Compression Fittings Metric

Bulkhead Locknut

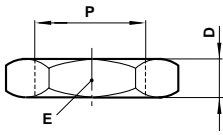

Product number	P thread	D	E A/F
36 0520 01	M12 x 1,0	5	17
36 0520 03	M15 x 1,0	6	22
36 0520 05	M18 x 1,5	6	24
36 0520 06	M20 x 1,5	7	27
36 0520 07	M24 x 1,5	7	30
36 0520 08	M30 x 1,5	8	41
36 0520 10	M38 x 1,5	9	46
36 0520 12	M48 x 1,5	10	55

Nippled Connector Male O/D tube

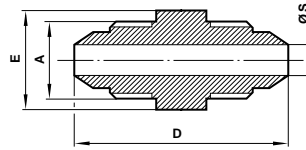

Product number	A O/D tube	D	E A/F	S
36 0632 02	4	28,0	8	2,2
36 0632 03	5	31,4	10	3,0
36 0632 04	6	31,4	13	4,0
36 0632 05	8	36,0	13	5,4
36 0632 06	10	39,0	17	7,0
36 0632 07	12	43,5	19	9,0

Male Connector

Male to male

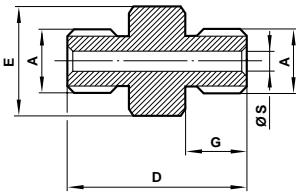

Product number	A thread	D	E A/F	G	S
36 0737 01	M5 x 0,8	15	7	5	2

Sealing washers should be ordered separately, quote: 48031400.

Unequal Connector

Female O/D tube to male O/D tube

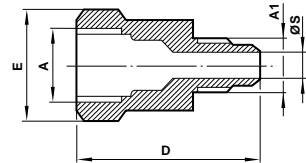

Product number	A1 O/D tube	A O/D tube	D	E A/F	S
36 0562 26	4	5	26	13	2,0
36 0562 27	4	6	26	13	2,0
36 0562 28	4	8	29	17	2,0
36 0562 37	5	6	26	13	2,0
36 0562 38	5	8	30	17	3,0
36 0562 47	6	8	30	17	4,0
36 0562 48	6	10	33	19	4,0
36 0562 56	8	10	35	19	5,2
36 0562 57	8	12	35	22	5,2
36 0562 64	10	12	36	22	7,5

Straight Connector

Female O/D tube

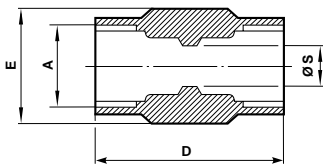

Product number	A O/D tube	D	E A/F	S
36 0503 02	4	22,0	10	2,8
36 0503 03	5	26,0	13	3,4
36 0503 04	6	26,0	13	4,0
36 0503 05	8	32,0	17	6,0
36 0503 06	10	35,0	19	7,6
36 0503 07	12	36,0	22	9,6
36 0503 15	15	40,0	27	12,6
36 0503 08	16	41,0	27	13,6
36 0503 18	18	43,5	32	15,3
36 0503 10	22	53,0	36	19,0
36 0503 12	28	64,0	46	25,0

Bracketed Straight Connector

Female O/D tube

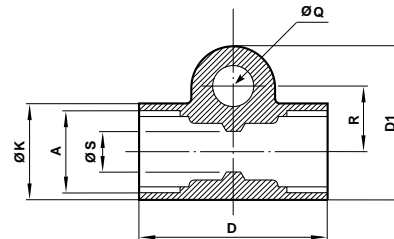

Product number	A O/D tube	D	D1	K	Q	R	S
36 0552 02	4	24,0	14,9	10,3	5,2 x 11,9	5,5	3,0
36 0552 03	5	27,0	22,2	14,3	6,75 x 15,9	8,7	4,0
36 0552 04	6	27,0	22,2	14,3	6,75 x 15,9	8,7	4,5
36 0552 05	8	33,3	24,6	17,5	6,75 x 19,0	9,5	6,5
36 0552 06	10	35,0	25,4	23,8	6,75 x 25,4	11,1	8,0
36 0552 07	12	37,0	29,4	23,8	6,75 x 25,4	11,1	10,0



Metric to Inch Adaptor

Inch O/D tube male to metric O/D tube female

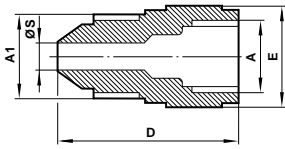

Product number	A O/D tube	A1 O/D tube	D	E A/F	S
36 0562 02	4	1/8"	18,5	10	1,6
36 0562 09	4	5/32"	17,5	10	2,4
36 0562 15	4	3/16"	22,0	10	2,8
36 0562 16	5	3/16"	24,0	13	2,8
36 0562 17	6	3/16"	27,0	13	2,8
36 0562 22	4	1/4"	20,0	13	2,8
36 0562 24	6	1/4"	23,5	13	3,2
36 0562 25	8	1/4"	25,5	17	3,2
36 0562 32	8	5/16"	25,0	17	6,0
36 0562 42	10	3/8"	28,0	19	6,3
36 0562 52	12	1/2"	32,0	22	9,6
36 0562 59	16	5/8"	34,5	30	13,6
36 0562 65	16	3/4"	36,0	30	13,6
36 0562 67	22	3/4"	48,5	36	16,0
36 0562 73	22	1 1/8"	45,0	36	19,0
36 0562 79	28	1 9/16"	54,0	46	25,0

Nippled Adaptor

Male tube to metric and UNF female thread

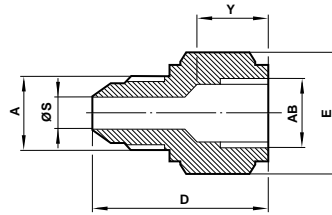

Product number	A1 O/D tube	AB thread	D	E A/F	S	V
36 0553 30	6	M8 x 1,0	21,5	13,0	4,0	8,0
36 0553 43	6	M10 x 1,0	26,0	14,0	4,0	11,0
36 0553 53	6	M14 x 1,4	27,5	19,0	4,0	11,0
36 0643 53	4	10 - 32 UNF	15,0	8,0	2,2	7,0

Nippled Adaptor

Male O/D tube to male taper BSP thread

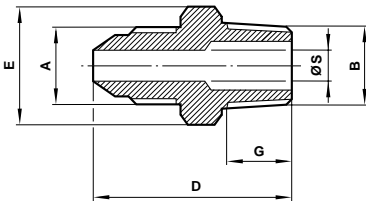

Product number	A O/D tube	B thread BSP	D	E A/F	G	S
36 0556 02	4	1/8"	26,0	13	9,5	2,2
36 0556 03	5	1/8"	27,5	13	9,5	3,0
36 0556 04	6	1/8"	27,5	13	9,5	4,0
36 0556 05	8	1/8"	30,0	14	9,5	5,0
36 0556 08	4	1/4"	28,5	14	11,1	2,2
36 0556 09	5	1/4"	30,0	14	11,1	3,0
36 0556 10	6	1/4"	30,0	14	11,1	4,0
36 0556 11	8	1/4"	32,0	14	11,1	5,4
36 0556 12	10	1/4"	33,5	17	11,1	6,4
36 0556 19	8	3/8"	37,0	19	12,7	5,4
36 0556 20	10	3/8"	38,0	19	12,7	7,0
36 0556 21	12	3/8"	40,0	19	12,7	9,0
36 0556 30	12	1/2"	44,0	22	15,9	9,0

Nippled Adaptor

Male O/D tube to female parallel BSP thread

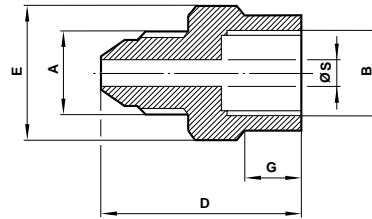

Product number	A O/D tube	B thread BSP	D	E A/F	G	S
36 0557 02	4	1/8"	24,0	13	7,5	2,2
36 0557 03	5	1/8"	24,5	13	7,5	3,0
36 0557 04	6	1/8"	24,5	13	7,5	4,0
36 0557 05	6	1/4"	28,0	17	11,0	4,0
36 0557 08	8	1/4"	30,0	17	11,0	5,4
36 0557 09	10	1/4"	31,5	17	11,0	7,0
36 0557 10	8	3/8"	30,5	22	11,5	5,4
36 0557 11	8	1/4"	32,0	22	11,5	7,0
36 0557 12	12	3/8"	34,0	22	11,5	9,0
36 0557 19	12	1/2"	39,5	27	15,0	9,0



Compression Fittings Metric

Straight Male Adaptor

Female O/D tube to male taper BSP thread

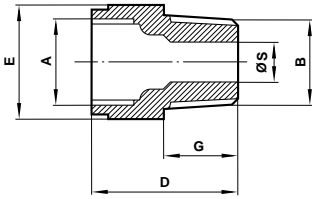

Product number	A O/D tube	B thread BSP	D	E A/F	G	S
36 0530 02	4	1/8"	18,5	13	9,5	2,8
36 0530 03	5	1/8"	20,0	13	9,5	3,4
36 0530 04	6	1/8"	20,0	14	9,5	4,0
36 0530 05	8	1/8"	26,5	17	9,5	4,7
36 0530 06	10	1/8"	28,0	19	9,5	4,7
36 0530 08	4	1/4"	18,0	14	11,1	2,8
36 0530 09	5	1/4"	21,6	14	11,1	3,4
36 0530 10	6	1/4"	21,6	14	11,1	4,0
36 0530 11	8	1/4"	23,0	17	11,1	6,0
36 0530 12	10	1/4"	30,0	19	11,1	7,0
36 0530 13	12	1/4"	31,1	22	11,1	6,4
36 0530 18	6	3/8"	21,0	19	12,7	4,0
36 0530 19	8	3/8"	21,0	19	12,7	6,0
36 0530 20	10	3/8"	26,0	19	12,7	8,0
36 0530 21	12	3/8"	29,0	22	12,7	9,6
36 0530 22	16	3/8"	35,0	30	12,7	10,0
36 0530 28	8	1/2"	25,0	22	15,9	6,0
36 0530 29	10	1/2"	27,0	22	15,9	8,0
36 0530 30	12	1/2"	30,0	22	15,9	10,0
37 0530 57	15	1/2"	31,0	27	15,9	12,6
36 0530 31	16	1/2"	38,5	30	15,9	13,6
36 0530 44	12	3/4"	33,0	30	19,5	10,0
36 0530 45	16	3/4"	35,0	30	19,1	13,6
37 0530 62	18	3/4"	35,0	32	19,0	15,3

Straight Male Adaptor (NPTF)

Female O/D tube to male NPTF thread

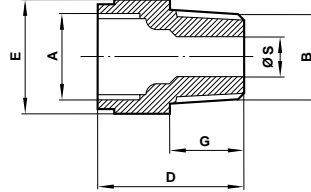

Product number	A O/D tube	B thread NPTF	D	E A/F	G	S
36 0532 03	5	1/8"	19,0	13	9,5	3,4
36 0532 04	6	1/8"	20,0	14	9,5	4,0
36 0532 05	8	1/8"	26,5	17	9,5	4,7
36 0532 09	5	1/4"	22,0	14	14,3	3,4
36 0532 10	6	1/4"	22,5	14	14,3	4,0
36 0532 11	8	1/4"	26,0	17	14,3	6,0
36 0532 12	10	1/4"	33,0	19	14,3	7,6
36 0532 13	12	1/4"	34,0	22	14,3	8,0
36 0532 19	8	3/8"	23,0	19	14,3	6,0
36 0532 20	10	3/8"	27,0	19	14,3	7,6
36 0532 21	12	3/8"	31,0	22	14,3	9,6
36 0532 29	10	1/2"	26,0	24	19,0	7,6
36 0532 30	12	1/2"	31,0	24	19,0	9,6
36 0532 31	16	1/2"	40,0	30	19,0	12,0

Straight Male Adaptor

Female O/D tube to metric male thread

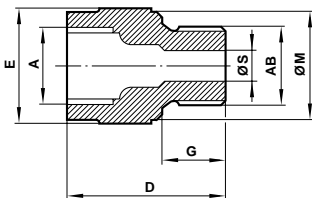

Product number	A1 O/D tube	AB thread	D	E A/F	G	M	S
36 0554 10	4	M8 x 1,0	19	13	8,1	12,0	2,8
36 0554 20	5	M8 x 1,0	21	13	8,0	12,0	3,0
36 0554 21	5	M10 x 1,0	20	14	8,0	13,5	3,4
36 0554 31	6	M10 x 1,0	20	17	8,1	14,0	4,0
36 0554 32	6	M12 x 1,0	20	17	8,1	16,5	4,0
36 0554 42	8	M12 x 1,0	25	17	8,1	16,5	5,0
36 0554 43	8	M12 X 1,5	26	17	10,0	16,5	5,5
36 0554 54	10	M14 X 1,5	28	19	10,1	18,5	6,0
36 0554 65	12	M16 X 1,5	28	22	10,1	21,0	7,6

Male Adaptor

Male metric to male taper BSP thread

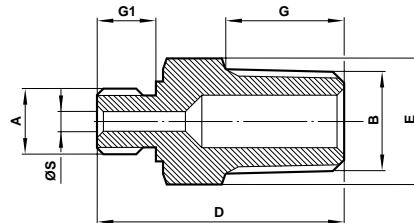

Product number	A1 thread	AB BSPT thread	D	E	G	G1	S
36 0738 02	M5 x 0,8	1/8"	20	10	9,5	5,0	2,0

Sealing washers should be ordered separately, quote 48031400.



Straight Male Adaptor

Female O/D tube to male parallel BSP thread

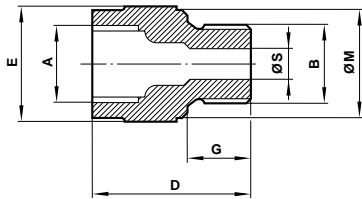

Product number	A O/D tube	B thread BSP	D	E A/F	G	M	S
36 0504 02	4	1/8"	15	13	7,4	13	2,8
36 0504 03	5	1/8"	18	13	7,4	13	3,4
36 0504 04	6	1/8"	21	17	7,4	14	4,0
36 0504 05	8	1/8"	25	17	7,4	14	5,0
36 0504 08	4	1/4"	18	19	11,0	18	2,8
36 0504 09	5	1/4"	20	19	11,0	18	3,4
36 0504 10	6	1/4"	21	19	11,0	18	4,0
36 0504 11	8	1/4"	25	19	11,0	18	6,0
36 0504 12	10	1/4"	30	19	11,0	18	7,0
36 0504 13	12	1/4"	30	22	11,0	18	7,0
36 0504 18	6	3/8"	22	22	11,4	21,5	4,0
36 0504 19	8	3/8"	23	24	11,4	22	6,0
36 0504 20	10	3/8"	24	24	11,4	22	7,6
36 0504 21	12	3/8"	29	24	11,4	22	9,6
36 0504 22	16	3/8"	34	27	11,4	22	10,0
36 0504 28	8	1/2"	25	27	15,0	26	6,0
36 0504 29	10	1/2"	25	27	15,0	26	7,6
36 0504 30	12	1/2"	27	27	15,0	26	9,6
36 0504 31	16	1/2"	36	27	15,0	26	13,6
36 0504 33	22	1/2"	44	36	15,0	26	13,6
36 0504 45	16	3/4"	32	36	16,3	32	13,6
36 0504 47	22	3/4"	43	36	16,3	32	19,0
36 0504 49	28	3/4"	53	46	16,3	32	19,0
36 0504 60	22	1"	42	41	19,1	39	19,0
36 0504 62	28	1"	52	46	19,1	39	25,0

Straight Adaptor

Female O/D tube to female parallel BSP thread

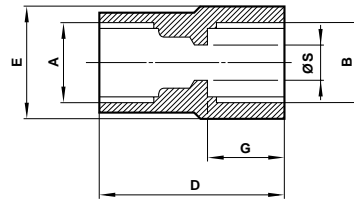

Product number	A O/D tube	B thread BSP	D	E A/F	G	S
36 0505 02	4	1/8"	23	13	9,5	2,8
36 0505 03	5	1/8"	25	13	9,5	3,4
36 0505 04	6	1/8"	25	13	9,5	4,0
36 0505 05	8	1/8"	28	17	9,5	6,0
36 0505 09	5	1/4"	27	17	11,0	3,4
36 0505 10	6	1/4"	27	17	11,0	4,0
36 0505 11	8	1/4"	30	17	11,0	6,0
36 0505 12	10	1/4"	31	19	11,0	7,6
36 0505 19	8	3/8"	32	22	12,7	6,0
36 0505 20	10	3/8"	33	22	12,7	7,6
36 0505 21	12	3/8"	33,5	22	12,7	9,6
36 0505 30	12	1/2"	37	27	16,0	9,6
36 0505 31	16	1/2"	38	30	16,0	13,6
36 0505 47	22	3/4"	48	36	17,5	19,0
36 0505 62	28	1"	55	46	19,0	25,0

Sealing washers should be ordered separately, see pages 9.6.001.42-43.

Universal Stem Elbow

O/D tube stem

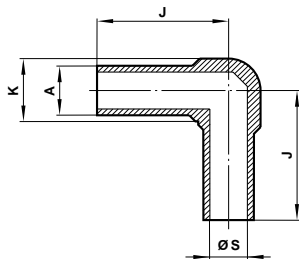

Product number	A O/D stem	J	K	S
36 0292 05	8	31,8	11,1	5,0

Stem Elbow Connector

Female O/D tube to O/D tube stem

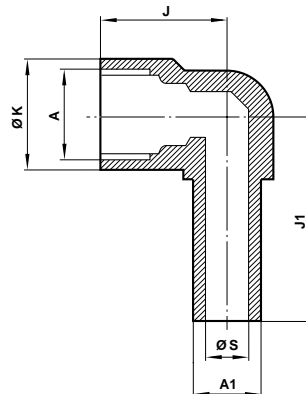

Product number	A O/D tube	A1 O/D stem	J	J1	K	S
36 0551 03	5	5	17	29,5	14,3	3
36 0551 04	6	6	19	30,6	14,3	4
36 0551 05	8	8	23	34,9	17,5	5
36 0551 06	10	10	23	41,3	23,0	7
36 0551 07	12	12	24	43,5	23,0	9
36 0551 08	16	16	30	53,0	30,0	12



Compression Fittings Metric

Elbow Connector

Female O/D tube

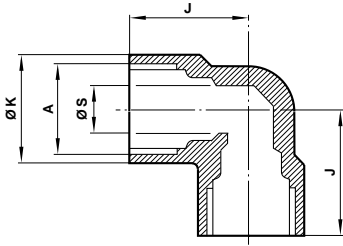

Product number	A O/D tube	D	E A/F	S
36 0511 02	4	13,5	11,1	2,8
36 0511 03	5	15,5	12,7	3,4
36 0511 04	6	16,0	14,3	4,0
36 0511 05	8	20,0	16,0	6,0
36 0511 06	10	23,0	20,0	7,6
36 0511 07	12	25,0	24,0	9,6
36 0511 15	15	29,0	27,8	12,6
36 0511 08	16	29,0	27,8	13,6
36 0511 18	18	32,0	30,9	15,3
36 0511 10	22	39,0	36,5	19,0
36 0511 12	28	45,0	47,6	25,0

Bracketed Elbow Connector

Female O/D tube

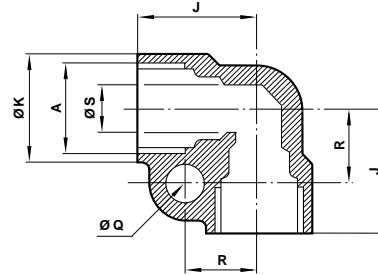

Product number	A O/D stem	J	K	Q	R	S
36 0548 02	4	13,5	10,3	5,2 x 11,9	7,1	3,0
36 0548 03	5	23,8	13,5	6,75 x 16,7	6,7	4,0
36 0548 04	6	21,0	16,7	6,75 x 19,0	7,8	4,5
36 0548 05	8	26,2	16,7	6,75 x 19,0	7,8	6,5
36 0548 06	10	25,4	22,2	6,75 x 25,4	11,2	8,0
36 0548 07	12	32,0	22,2	6,75 x 25,4	11,2	10,0

Female Elbow Adaptor

Female O/D tube to female parallel BSP thread

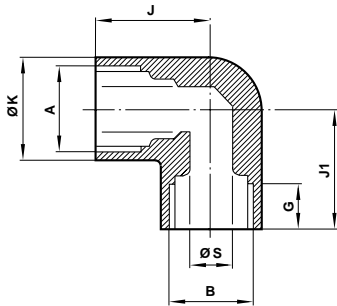

Product number	A O/D stem	B thread BSPP	G	J A/F	J1	K	S
36 0555 02	4	1/8"	7,4	14,0	12,5	12,7	2,8
36 0555 03	5	1/8"	7,4	15,5	12,5	12,7	3,4
36 0555 10	6	1/4"	11,0	16,0	17,5	17,5	4,0
36 0555 11	8	1/4"	11,0	20,0	18,5	17,5	6,0
36 0555 12	10	1/4"	11,0	22,0	18,5	20,6	7,6
36 0555 20	10	3/8"	11,4	21,5	22,0	20,6	7,6
36 0555 21	12	3/8"	11,4	24,5	22,0	23,8	9,6
36 0555 22	16	3/8"	11,4	28,0	22,0	28,5	13,6
36 0555 30	12	1/2"	15,0	24,5	26,0	24,6	9,6
36 0555 31	16	1/2"	15,0	28,0	29,0	28,5	13,6



Male Elbow Adaptor

Female O/D tube to male taper BSP thread

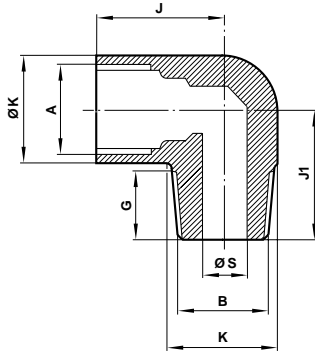

Male Elbow Adaptor

Female O/D tube to male NPTF thread

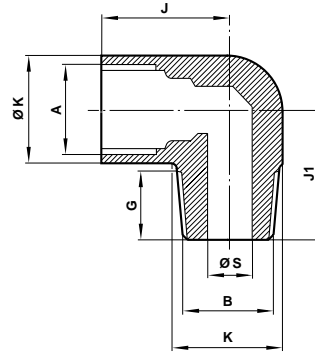

Product number	A O/D tube	B thread BSP	G	J	J1	K	S
36 0005 02	4	1/8"	9,5	14,9	15,5	11,1	4,7
36 0005 03	5	1/8"	9,5	16,5	17,0	12,7	4,7
36 0005 04	6	1/8"	9,5	16,5	18,2	14,3	4,7
36 0005 05	8	1/8"	9,5	20,0	20,0	15,9	4,7
36 0005 08	4	1/4"	11,11	15,7	19,8	14,3	6,3
36 0005 09	5	1/4"	11,11	16,5	19,8	14,3	6,3
36 0005 10	6	1/4"	11,11	17,2	19,0	14,3	6,3
36 0005 11	8	1/4"	11,11	20,6	21,0	15,9	6,3
36 0005 12	10	1/4"	11,11	21,0	23,0	20,6	6,3
36 0005 13	12	1/4"	11,11	22,2	25,0	23,8	6,3
36 0005 18	6	3/8"	12,7	18,2	24,0	17,4	9,6
36 0005 19	8	3/8"	12,7	21,8	24,0	17,4	9,6
36 0005 20	10	3/8"	12,7	22,0	24,0	20,6	9,6
36 0005 21	12	3/8"	12,7	24,5	26,0	23,8	9,6
36 0005 22	16	3/8"	12,7	25,8	28,0	28,6	9,6
36 0005 28	8	1/2"	15,9	23,4	28,5	23,8	12,7
36 0005 29	10	1/2"	15,9	24,9	28,5	23,8	12,7
36 0005 30	12	1/2"	15,9	25,4	33,0	28,6	12,6
37 0005 57	15	1/2"	15,9	27,0	32,0	28,6	12,7
36 0005 31	16	1/2"	15,9	28,0	32,0	28,6	12,7
36 0005 45	16	3/4"	19,0	29,0	34,5	28,6	17,5
37 0005 62	18	3/4"	19,1	31,0	37,5	31,8	17,5

Product number	A O/D tube	B NPTF thread	G	J	J1	K	S
36 0331 03	5	1/8"	9,5	16,5	17,4	12,7	4,7
36 0331 04	6	1/8"	9,5	16,5	18,2	14,3	4,7
36 0331 05	8	1/8"	9,5	20,0	20,0	15,9	4,7
36 0331 09	5	1/4"	14,3	17,2	24,6	15,9	6,3
36 0331 10	6	1/4"	14,3	17,2	24,6	25,9	6,3
36 0331 11	8	1/4"	14,3	20,6	24,6	15,9	6,3
36 0331 12	10	1/4"	14,3	22,0	27,0	20,6	6,3
36 0331 13	12	1/4"	14,3	23,0	28,6	24,5	6,3
36 0331 20	10	3/8"	14,3	23,5	27,0	20,6	9,6
36 0331 21	12	3/8"	14,3	24,5	28,6	24,5	9,6
36 0331 30	12	1/2"	19,1	26,0	35,0	28,6	12,7
36 0331 31	16	1/2"	19,1	27,0	35,0	28,6	12,7



Compression Fittings Metric

Stem Tee Connector

Female O/D tube to O/D tube stem

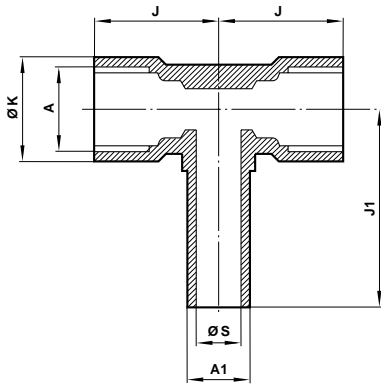

Product number	A O/D tube	A1 O/D stem	J	J1	K	S
36 0550 03	5	5	14,5	29,5	14,3	3
36 0550 04	6	6	16,8	30,6	14,3	4
36 0550 05	8	8	18,5	34,9	17,5	5
36 0550 06	10	10	21,0	41,3	23,3	7
36 0550 07	12	12	22,5	43,5	23,0	9
36 0550 08	16	16	27,5	55,0	35,0	12
36 0550 10	22	22	38,0	60,0	35,0	18
36 0550 12	28	28	45,0	75,0	45,0	23

90° Stem Tee Connector

Female O/D tube to O/D tube stem

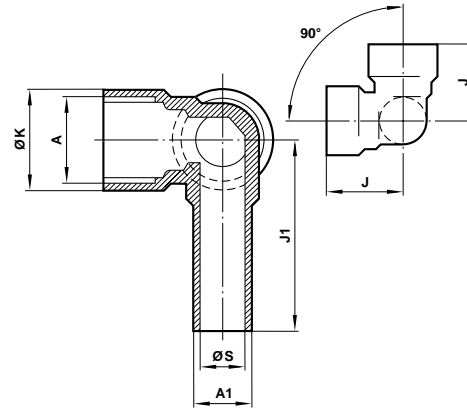

Product number	A O/D tube	A1 O/D stem	J	J1	K	S
36 0631 03	5	5	17	29,5	12,3	3
36 0631 04	6	6	19	30,6	14,3	4
36 0631 05	8	8	23	34,9	17,5	5
36 0631 06	10	10	23	41,3	23,2	7
36 0631 07	12	12	25	43,5	23,2	9

Side Stem Tee Connector

Female O/D tube to O/D tube stem

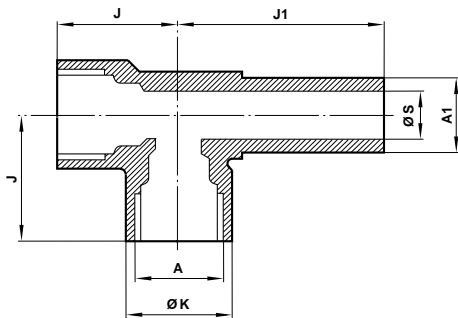

Product number	A O/D tube	A1 O/D stem	J	J1	K	S
36 0626 03	5	5	17	29,5	12,3	3
36 0626 04	6	6	19	30,6	14,3	4
36 0626 05	8	8	23	34,9	17,5	5
36 0626 06	10	10	24	41,3	23,0	7
36 0626 07	12	12	26	43,5	23,0	9

Tee Connector

Female O/D tube

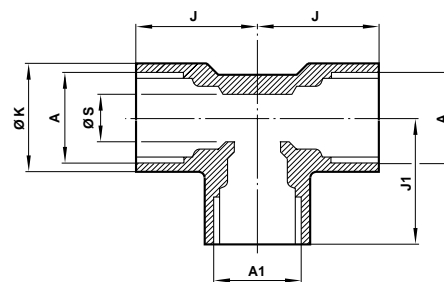

Product number	A O/D tube	A1 O/D stem	J	J1	K	S
36 0514 02	4	4	12,5	12,5	10,3	2,8
36 0514 03	5	5	15,5	15,5	12,7	3,4
36 0514 04	6	6	16,0	16,0	14,3	4,0
36 0514 05	8	8	20,0	20,0	16,0	6,0
36 0514 06	10	10	23,0	23,0	20,0	7,6
36 0514 07	12	12	25,0	25,0	24,0	9,6
36 0514 15	15	15	28,0	28,0	28,6	12,6
36 0514 08	16	16	28,0	28,0	28,6	13,6
36 0514 18	18	18	32,0	32,0	31,0	17,5
36 0514 10	22	22	39,0	39,0	36,5	19,0
36 0514 12	28	28	45,0	45,0	47,6	25,0



Bracketed Tee Connector

Female O/D tube

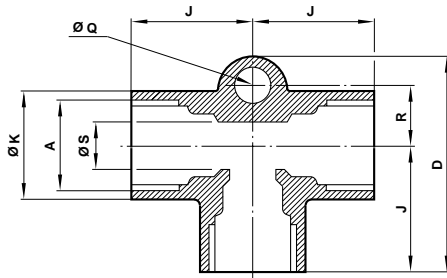

Product number	A1 O/D tube	D	J	K	Q	R	S
36 0549 02	4	23,2	13,5	10,3	5,20 x 11,9	5,5	3,0
36 0549 03	5	31,1	16,0	14,3	6,75 x 15,9	8,7	4,0
36 0549 04	6	31,6	16,5	14,3	6,75 x 15,9	8,7	4,5
36 0549 05	8	36,4	20,5	17,5	6,75 x 19,0	9,5	6,5
36 0549 06	10	40,5	23,0	23,8	6,75 x 25,4	11,1	8,0
36 0549 07	12	42,0	24,5	23,8	6,75 x 25,4	11,1	9,6

Male Tee Adaptor

Female O/D tube to male taper BSP thread

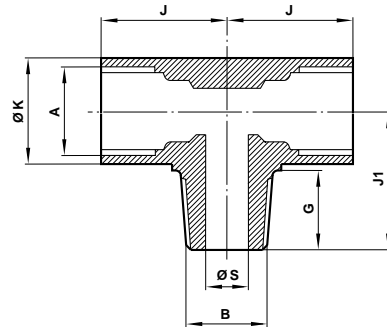

Product number	A O/D tube	B thread BSP	G	J	J1	K	S
36 0627 03	5	1/8"	9,5	16,5	17,0	12,7	3,5
36 0627 04	6	1/8"	9,5	16,5	18,0	14,3	3,5
36 0627 11	8	1/4"	11,1	21,0	20,0	15,9	6,3
36 0627 12	10	1/4"	11,1	22,0	23,0	19,0	6,3
36 0627 21	12	3/8"	12,7	24,5	26,0	23,8	9,5

Male Side Tee Adaptor

Female O/D tube to male taper BSP thread

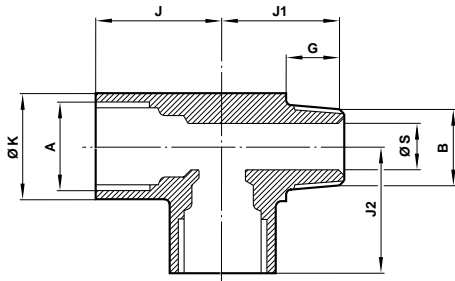

Product number	A O/D tube	B thread BSP	G	J	J1	J2	K	S
36 0628 03	5	1/8"	9,5	15,5	17,0	15,5	12,7	3,5
36 0628 04	6	1/8"	9,5	16,0	18,5	16,0	14,3	4,0
36 0628 11	8	1/4"	11,1	20,0	22,0	20,0	15,9	6,0
36 0628 12	10	1/4"	11,1	23,0	23,0	23,0	19,0	6,4
36 0628 21	12	3/8"	12,7	25,0	27,0	25,0	23,8	9,6

'Y' Connector

Female O/D tube

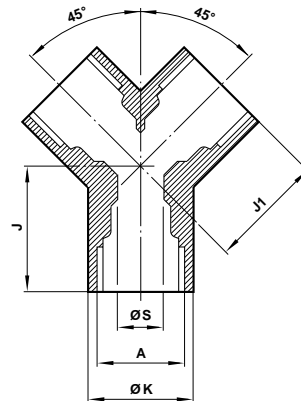

Product number	A O/D tube	J	J1	K	S
36 0558 02	4	14,0	14	11,1	2,8
36 0558 03	5	15,0	16	12,7	3,4
36 0558 04	6	16,0	17	14,3	4,0
36 0558 05	8	18,5	20	17,5	6,0
36 0558 06	10	20,5	22	23,8	7,6
36 0558 07	12	22,0	24	23,8	9,6
36 0558 08	16	25,0	29	31,8	13,6
36 0558 10	22	32,0	37	35,7	19,0
36 0558 12	28	40,0	45	44,5	25,0

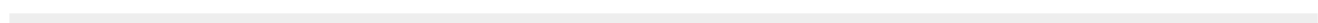



Hobbs Couplings

The design of a Hobbs coupling allows the fittings to be screwed into a parallel BSP tapping and accurately located for position in both height and direction before it is secured with the special coned locknut and polyurethane seal. Wring locknut down metal to metal to create an effective seal.

Hobbs Straight Connector

Male parallel BSP thread both ends.

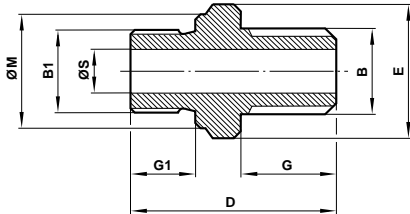

Product number	B thread BSP	B1 thread BSP	D	E A/F	G	G1	M	S
36 0543 01	1/8"	1/8"	27,0	13	14,0	14,0	13	5,0
36 0543 02	1/4"	1/4"	35,5	19	17,5	17,5	18	7,0
36 0543 03	3/8"	3/8"	40,0	24	20,0	20,0	22	10,0
36 0543 04	1/2"	1/2"	48,0	27	23,0	23,0	26	13,6
36 0543 06	3/4"	3/4"	52,5	36	25,4	25,4	32	19,0
36 0543 08	1"	1"	64,0	41	31,8	31,8	39	25,0
36 0543 11	1/4"	1/8"	31,5	17	17,5	17,5	14	5,0
36 0543 20	3/8"	1/4"	39,0	19	20,0	20,0	18	7,0
36 0543 28	1/2"	3/8"	44,0	24	23,0	23,0	22	10,0
36 0543 36	3/4"	1/2"	51,0	27	25,4	25,4	26	13,6
36 0543 47	1"	3/4"	61,0	36	31,8	31,8	32	19,0

Hobbs Elbow Adaptor

Female O/D tube to male parallel BSP thread

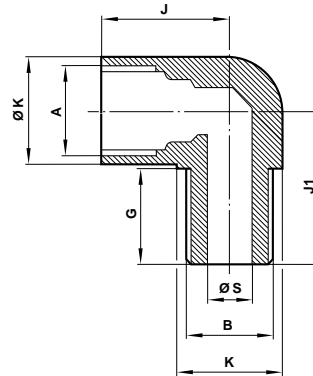

Product number	A O/D tube	B thread BSP	G	J	J1	K	S
36 0541 02	4	1/8"	14,0	14,9	22,0	11,3	4,7
36 0541 03	5	1/8"	14,0	16,5	22,0	14,3	4,7
36 0541 04	6	1/8"	14,0	16,5	22,0	14,3	4,7
36 0541 05	8	1/8"	14,0	19,4	23,8	15,8	4,7
36 0541 08	4	1/4"	17,5	15,7	25,4	14,3	6,3
36 0541 09	5	1/4"	17,5	17,2	25,4	14,3	6,3
36 0541 10	6	1/4"	17,5	17,2	25,4	14,3	6,3
36 0541 11	8	1/4"	17,5	20,6	27,0	15,8	6,3
36 0541 12	10	1/4"	17,5	21,7	30,1	23,8	6,3
36 0541 13	12	1/4"	17,5	22,2	30,1	23,8	6,3
36 0541 18	6	3/8"	20,0	18,2	30,2	17,4	9,6
36 0541 19	8	3/8"	20,0	21,8	30,2	17,4	9,6
36 0541 20	10	3/8"	20,0	23,3	33,0	20,0	9,6
36 0541 21	12	3/8"	20,0	24,5	33,0	23,8	9,6
36 0541 22	16	3/8"	20,0	25,8	35,0	28,6	9,6
36 0541 28	8	1/2"	23,0	23,4	36,5	23,8	12,7
36 0541 29	10	1/2"	23,0	24,9	36,5	23,8	12,7
36 0541 30	12	1/2"	23,0	25,4	36,5	23,8	12,7
36 0541 31	16	1/2"	23,0	28,0	38,0	28,6	12,7
36 0541 33	22	1/2"	23,0	32,9	42,0	36,5	12,7
36 0541 45	16	3/4"	25,4	29,8	43,7	31,8	17,5
36 0541 47	22	3/4"	25,4	36,5	45,2	36,5	17,5
36 0541 49	28	3/4"	25,4	40,8	49,0	44,5	17,5
36 0541 60	22	1"	32,0	38,5	50,8	36,5	24,0
36 0541 62	28	1"	32,0	45,0	56,5	44,5	24,0

Hobbs Coned Locknut

Female parallel BSP thread

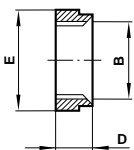

Product number	B thread BSP	D	E A/F
36 0540 02	1/8"	7,0	17
36 0540 03	1/4"	8,4	19
36 0540 04	3/8"	9,6	24
36 0540 05	1/2"	10,9	27
36 0540 06	3/4"	10,9	32
36 0540 07	1"	13,3	41

Hobbs Seal

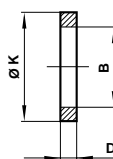

Product number	B thread BSP	D	E A/F
34 0156 02	1/8"	2	12,7
34 0156 03	1/4"	2,5	15,9
34 0156 04	3/8"	2,5	20,7
34 0156 05	1/2"	2,6	24,3
34 0156 06	3/4"	2,6	30,2
34 0156 07	1"	3,2	37,2



Compression Fittings Metric

Hobbs Tee Adaptor

Female O/D tube to male parallel BSP thread

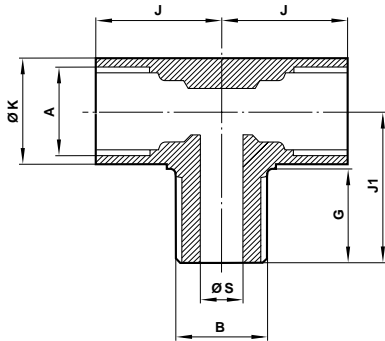

Product number	A O/D tube	B thread BSP	G	J	J1	K	S
36 0542 02	4	1/8"	14,0	14,9	22,0	14,3	4,7
36 0542 03	5	1/8"	14,0	16,5	22,0	14,3	4,7
36 0542 04	6	1/8"	14,0	16,5	22,0	14,5	4,7
36 0542 05	8	1/8"	14,0	19,4	23,8	15,8	4,7
36 0542 08	4	1/4"	17,5	15,7	25,4	14,3	6,3
36 0542 09	5	1/4"	17,5	17,2	25,4	14,3	6,3
36 0542 10	6	1/4"	17,5	17,2	25,4	14,3	6,3
36 0542 11	8	1/4"	17,5	20,6	27,0	15,8	6,3
36 0542 12	10	1/4"	17,5	21,7	30,1	23,8	6,3
36 0542 13	12	1/4"	17,5	22,2	30,1	23,8	6,3
36 0542 18	6	3/8"	20,0	19,0	30,2	17,4	9,6
36 0542 19	8	3/8"	20,0	21,8	30,2	17,4	9,6
36 0542 20	10	3/8"	20,0	23,3	33,0	23,8	9,6
36 0542 21	12	3/8"	20,0	24,5	33,0	23,8	9,6
36 0542 22	16	3/8"	20,0	25,8	35,0	28,5	9,6
36 0542 28	8	1/2"	23,0	23,4	36,5	23,8	12,7
36 0542 29	10	1/2"	23,0	24,9	36,5	23,8	12,7
36 0542 30	12	1/2"	23,0	25,4	36,5	23,8	12,7
36 0542 31	16	1/2"	23,0	28,0	38,0	28,5	12,7
36 0542 33	22	1/2"	23,0	32,9	44,0	36,5	12,7
36 0542 45	16	3/4"	25,4	29,8	43,7	31,8	17,5
36 0542 47	22	3/4"	25,4	36,5	45,2	36,5	17,5
36 0542 49	28	3/4"	25,4	40,8	50,0	44,5	17,5
36 0542 60	22	1"	32,0	38,5	51,3	36,5	24,0
36 0542 62	28	1"	32,0	45,0	56,5	44,5	24,0



Tubing Nut

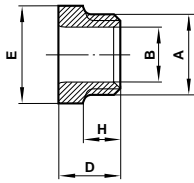

Product number	A thread	B O/D tube	D A/F	E	H
36 0500 02	M8 x 1,0	4	9,5	8	8,0
36 0500 03	M10 x 1,0	5	10,0	10	7,0
36 0500 04	M11 x 1,0	6	10,5	13	8,0
36 0500 05	M13 x 1,0	8	12,1	13	9,0
36 0500 06	M15 x 1,0	10	13,3	17	9,5
36 0500 07	M18 x 1,5	12	15,7	19	10,0
37 0500 15	M22 x 1,5	15	17,0	22	10,0
36 0500 08	M24 x 1,5	16	17,1	24	11,0
37 0500 18	M26 x 1,5	18	19,5	27	12,0
36 0500 10	M30 x 1,5	22	21,5	30	15,0
36 0500 12	M38 x 1,5	28	24,5	41	18,0

For 'A' thread details refer to page 9.6.001.03.

'O'-Ring Seal

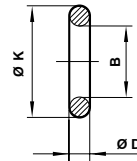

Product number	A for BSP thread	D	K
48 0261 06	1/8"	2,1	16,0
48 0261 06	1/4"	2,1	20,6
48 0261 06	3/8"	2,1	23,8
48 0261 06	1/2"	2,5	28,6
48 0261 06	5/8"	2,5	31,7
48 0261 06	3/4"	2,5	34,9

The 'O'-ring seals shown on this page are suitable for use with our metric range of parallel threaded adaptors.

Folded Copper Washer

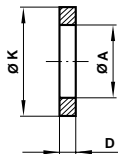

Product number	A	Suitable for			D	K
		BSP thread	or metric thread	or imperial thread		
48 0213 01	9,8	1/8"	-	3/8" x 24TPI	1,5	13,5
48 0213 02	13,2	1/4"	-	-	1,5	17,7
48 0213 03	16,7	3/8"	M16	-	1,5	21
48 0213 04	21,0	1/2"	-	-	1,5	26,4
48 0213 05	23,0	5/8"	-	-	1,8	28,6
48 0213 06	26,5	3/4"	-	-	1,8	32,4
48 0213 07	30,2	7/8"	M30	-	1,8	36,2
48 0213 08	33,3	1"	M33	-	1,8	38,9
48 0213 09	42,0	1 1/4"	-	-	2,2	49,9
48 0213 27	11,1	-	-	7/16" x 24TPI	1,5	14,6
48 0213 28	12,7	-	-	1/2" x 24TPI	1,5	17,7
48 0213 29	14,3	-	M14	9/16" x 24TPI	1,5	18,5
48 0213 30	19,1	-	-	3/4" x 24TPI	1,5	24,1
48 0213 41	8,3	-	M8	-	1,5	12
48 0213 42	10,3	-	M10	-	1,5	14
48 0213 43	12,1	-	M12	-	1,5	17

Universal Tubing Sleeve

Suitable for nylon metallic tubing

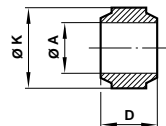

Product number	A O/D tube	D	K
36 0501 02	4	4,2	6,4
36 0501 03	5	5,2	7,5
36 0501 04	6	5,5	8,5
36 0501 05	8	6,3	10,5
36 0501 06	10	7,0	13,0
36 0501 07	12	7,7	15,5
37 0501 15	15	9,1	19,5
36 0501 08	16	9,0	20,0
37 0501 18	18	10,1	23,0
36 0501 10	10	10,5	26,5
36 0501 12	28	13,2	33,0

Sealing Washers – for use with banjo fitting

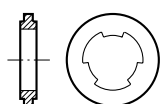

Nylon

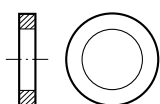

Copper

Product number	Size	Material
48 0314 00	M5	Nylon
48 0314 00	1/8"	Copper
48 0314 00	1/4"	Copper
48 0314 00	3/8"	Copper
48 0314 00	1/2"	Copper

Tubing Sleeve

Suitable for metallic tubing only

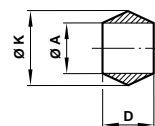

Product number	A O/D tube	D	K
36 0502 02	4	4,6	5,7
36 0502 03	5	5,0	6,8
36 0502 04	6	5,5	8,0
36 0502 05	8	6,3	10,3
36 0502 06	10	7,5	12,6
36 0502 07	12	7,5	14,9
37 0502 15	15	9,0	18,3



Compression Fittings Metric

Elbow Banjo Assembly

Non Regulating BSPP Bolt

Female O/D tube to male parallel BSP thread

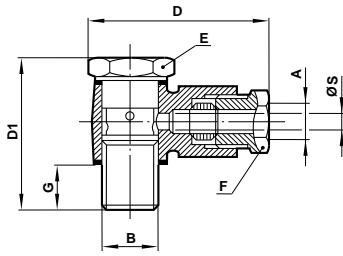

Product number	A O/D tube	B thread BSPP	D*	D1	E A/F	F A/F	G	S
36 0385 02K	4	1/8"	32	29	14	8	6,5	2,8
36 0385 03K	5	1/8"	35	29	14	10	6,5	3,4
36 0385 04K	6	1/8"	35	29	14	13	6,5	4,0
36 0385 05K	8	1/8"	39	29	14	13	6,5	6,0
36 0385 10K	6	1/4"	38	33	17	13	7,5	4,0
36 0385 11K	8	1/4"	42	33	17	13	7,5	6,0
36 0385 12K	10	1/4"	44	33	17	17	7,5	7,6
36 0385 19K	8	3/8"	48	41	22	13	10,0	6,0
36 0385 20K	10	3/8"	49	41	22	17	10,0	7,6
36 0385 21K	12	3/8"	50	41	22	19	10,0	9,6
36 0385 29K	10	1/2"	54	49	27	17	14,0	7,6
36 0385 30K	12	1/2"	56	49	27	19	14,0	9,6

*This dimension will vary with torque applied and is for guidance only.

Elbow Banjo Assembly

Regulating BSPP Bolt

Female O/D tube to male parallel BSP thread

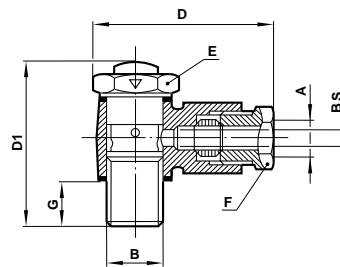

Product number	A O/D tube	B thread BSPP	D*	D1	E A/F	F A/F	G	S
36 0386 03K	5	1/8"	35	34	14	10	6,5	3,4
36 0386 05K	8	1/8"	39	34	14	13	6,5	6,0
36 0386 11K	8	1/4"	42	36,5	17	13	7,5	6,0

*This dimension will vary with torque applied and is for guidance only.
Arrow on bolt hexagon indicates free flow direction.

Tee Banjo Assembly

Non Regulating BSPP Bolt

Female O/D tube to male parallel BSP thread

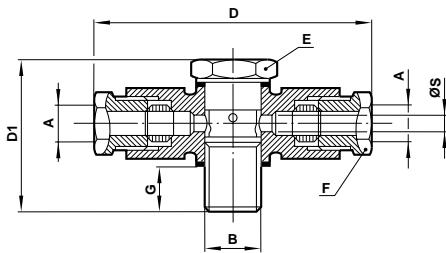

Product number	A O/D tube	B thread BSPP	D*	D1	E A/F	F A/F	G	S
36 0395 03K	5	1/8"	53	29	14	10	6,5	3,4
36 0395 04K	6	1/8"	54	29	14	13	6,5	4,0
36 0395 10K	6	1/4"	56	33	17	13	7,5	4,0
36 0395 11K	8	1/4"	64	33	17	13	7,5	6,0
36 0395 12K	10	1/4"	68	33	17	17	7,5	7,6
36 0395 19K	8	3/8"	70	41	22	13	10,0	6,0

*This dimension will vary with torque applied and is for guidance only.

Elbow Banjo Body

O/D tube

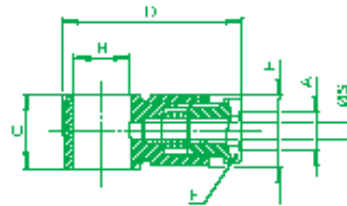

Product number	A O/D tube	B for BSP bolt	C	D*	E	F	S
36 0384 02K	4	1/8"	14,0	32	11,5	8	2,8
36 0384 03K	5	1/8"	14,0	35	13,0	10	3,4
36 0384 04K	6	1/8"	14,0	35	14,0	13	4,0
36 0384 05K†	8	1/8"	16,0	39	16,0	13	6,0
36 0384 10K	6	1/4"	16,0	38	14,0	13	4,0
36 0384 11K	8	1/4"	16,0	42	16,0	13	6,0
36 0384 12K†	10	1/4"	18,5	44	18,5	17	7,6
36 0384 19K	8	3/8"	20,5	48	17,0	13	6,0
36 0384 20K	10	3/8"	20,5	49	18,5	17	7,6
36 0384 21K	12	3/8"	21,5	50	21,5	19	9,6
36 0384 29K	10	1/2"	22,0	54	18,5	17	7,6
36 0384 30K	12	1/2"	22,0	56	21,5	19	9,6

*This dimension will vary with torque applied and is for guidance only.

† To double stack these bodies order longer bolts 36 0452 11K or 36 0452 12K, see below.



Tee Banjo Body
O/D tube

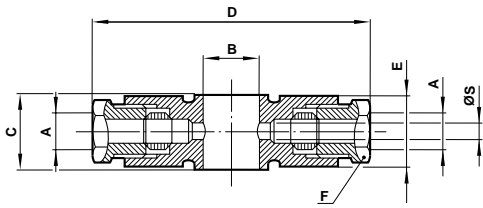

Product number	A O/D tube	B for BSP bolt	C	D*	E	F	S
36 0394 03K	5	1/8"	14,0	53	13,0	10	3,4
36 0394 04K	6	1/8"	14,0	54	14,0	13	4,0
36 0394 10K	6	1/4"	16,0	56	14,0	13	4,0
36 0394 11K	8	1/4"	16,0	64	16,0	13	6,0
36 0394 12K†	10	1/4"	18,5	68	18,5	17	7,6
36 0394 19K	8	3/8"	20,5	70	17,0	13	6,0

* This dimension will vary with torque applied and is for guidance only.
† To double stack this body order longer bolt 36 0452 12K, see below.

Banjo Bolts – Regulating

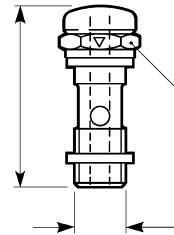

Regulating Out
Male parallel BSP thread

Product number	B thread BSP	D1	E A/F
39 0461 01K	1/8"	34	14
39 0461 02K	1/4"	37	17
39 0461 03K	3/8"	52	22
39 0461 04K	1/2"	58	27

Regulating In
Male parallel BSP thread

Product number	B thread BSP	D1	E A/F
39 0460 01K	1/8"	34	14
39 0460 02K	1/4"	37	17
39 0460 03K	3/8"	52	22
39 0460 04K	1/2"	58	27

Bi-Directional Flow
Male parallel BSP thread

Product number	B thread BSP	D1	E A/F
39 0459 01K	1/8"	34	14
39 0459 01K	1/4"	37	17
39 0459 01K	3/8"	52	22
39 0459 01K	1/2"	58	27

All banjo bolts supplied complete with sealing washers. Arrow on bolt hexagon indicates free flow direction.

Banjo Bolts - Non Regulating
Single stacking
Male parallel BSP thread

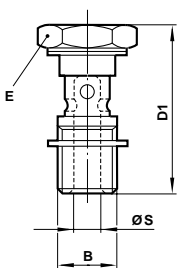

Product number	B thread BSP	D1	E A/F	S
36 0451 01K	1/8"	29	14	4,5
36 0451 02K	1/4"	33	17	5,5
36 0451 03K	3/8"	41	22	9,2
36 0451 04K	1/2"	49	27	10,5

All banjo bolts supplied complete with sealing washers.

Double stacking
Male parallel BSP thread

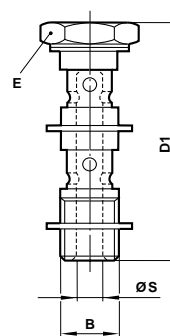

Product number	B thread BSP	D1	E A/F	S
36 0452 01K	1/8"	44,0	14	4,5
36 0452 02K	1/4"	50,0	17	5,5
36 0452 03K	3/8"	62,5	22	9,2
36 0452 04K	1/2"	74,0	27	10,5
36 0452 11K*	1/8"	47,5	14	4,5
36 0452 12K*	1/4"	55,0	17	5,5

* To be used only with bodies marked †, see tables above.

Warning

These products are intended for use in industrial compressed air systems only. Do not use these products where pressures and temperatures can exceed those listed under **Technical Data**. Before using these products with fluids other than those specified, for non-industrial applications, life-support systems, or other applications not within published specifications, consult Norgren. Through misuse, age, or malfunction, components used in fluid power systems can fail in various modes. The system designer is warned to consider the failure modes of all component parts used in fluid power systems and to provide adequate safeguards to prevent personal injury or damage to equipment in the event of such failure. **System designers must provide a warning to end users in the system instructional manual if protection against a failure mode cannot be adequately provided.** System designers and end users are cautioned to review specific warnings found in instruction sheets packed and shipped with these products where applicable.