

# Digital Temperature Controllers

## E5□N

### 1/16, 1/8, and 1/4 DIN Temperature Controllers Join the Best-selling E5□N Series

- Models available with either temperature inputs or analog inputs.
- A wide range of functions, such as three-phase heater burnout detection, two control outputs, manual outputs, and transfer outputs.
- Easy-to-read 11-segment display.
- Faster sampling at 250 ms.
- Setting Tool port provided as a standard feature for easy connection to personal computers.

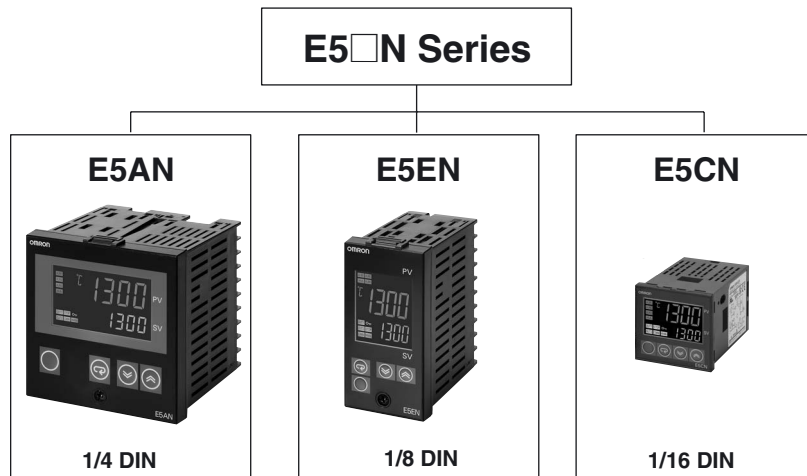

### Contents

<b>Digital Temperature Controllers</b>	
E5CN/E5CN-U .....	3
E5EN .....	16
E5AN .....	27
<b>Common to All Controllers</b>	
• Operation .....	37
• Precautions .....	43

# Lineup

**E5CN**  
(48 × 48 mm)  
Page 3

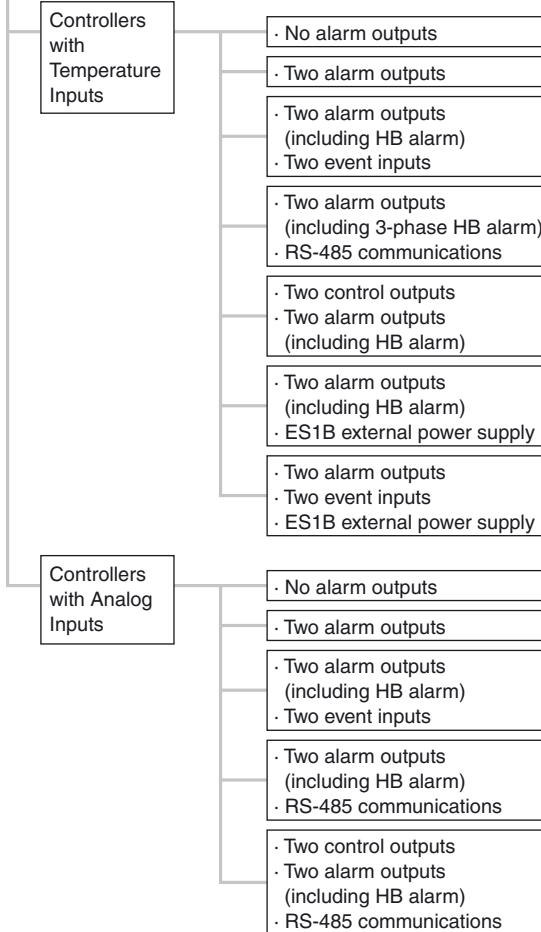
**E5EN**  
(48 × 96 mm)  
Page 16

**E5CN-U**  
Plug-in-type Controllers  
(48 × 48 mm)  
Page 3

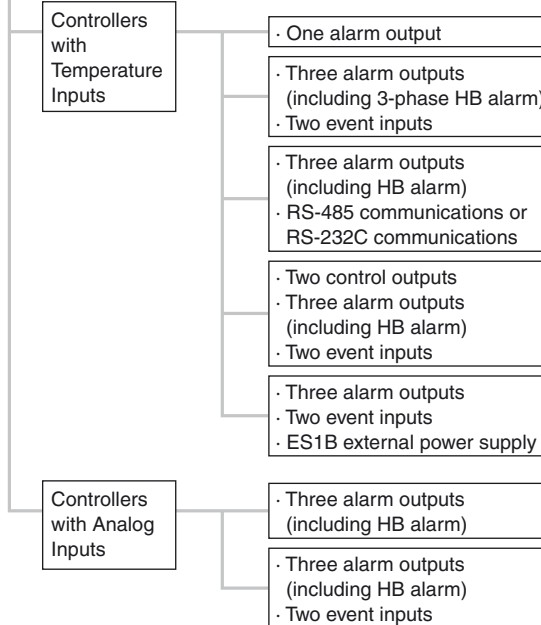
**E5AN**  
(96 × 96 mm)  
Page 27

# Digital Temperature Controllers E5CN/E5CN-U

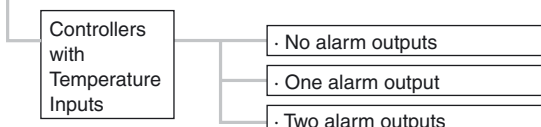
**This Best-selling General-purpose 48×48-mm Temperature Controller Is Now Even Better. USB-Serial Conversion Cable and Support Software Are Also Available.**

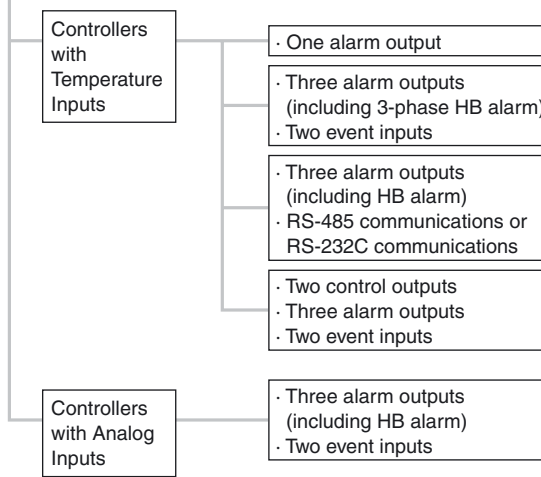
- Controllers now available with analog inputs.
- Faster sampling at 250 ms.
- Transfer output provided for easy output to recorders.
- Voltage outputs (to drive SSRs) for both heating and cooling control. Can be used for alarms to provide three alarm outputs.
- Models available with three-phase heater burnout detection and SSR fault detection.
- Easy setting with 11-segment displays.
- Connect to either a thermocouple or platinum resistance thermometer with the same model.
- Easily see the status from a distance with PV display with three-color switching function.
- Setting protection indicator informs operator when protection is enabled.
- Manual output provided.
- Controller available with long-life relay output.
- Models available with external power supply for ES1B Infrared Thermosensor.

**Note:** Refer to Precautions on page 43.

## Features

### Improved Functions for a Wider Range of Application

#### Control Analog Values, such as Pressures, Flowrates, and Levels

The E5CN Series now also includes models that accept analog inputs, enabling control applications other than for temperature, including pressure, flowrate, level, humidity, and weight control.

**Note:** E5CN-□L (Models with Analog Inputs)

#### Faster Sampling at 250 ms

The previous sampling time of 500 ms has been reduced by half to 250 ms. This enables the E5CN to handle application requiring even greater response speed and accuracy.

#### Easy Connector to a Recorder

A transfer output now makes it easy to connect to a recorder or PLC Analog I/O Unit.

**Note:** E5CN-C□ (Models with Current Outputs)



**Note:** Refer to page 40 for information on changes in comparison to previous models.

#### Voltage Outputs (to Drive SSRs) for Both Heating and Cooling Control. Can Be Used for Alarms to Provide Three Alarm Outputs.

Voltage outputs can be used for both heating and cooling for Models with Two Control Outputs. Also, control output 2 can be set for use as an alarm output, to enable using up to three alarm outputs.

**Note:** E5CN-□Q (Option Board)

#### Three-phase Heater Burnout Detection

With Models with Three-phase Heater Burnout and SSR Failure Detection, two current transformers can be connected to detect both heater burnout and SSR failure at the same time, reducing costs because a separate heater burnout alarm device is not required. SSR failure detection can be used even with Models with Single-phase Heater Burnout Alarms.

**Note:** E5CN-□HH□ (Option Board)

### E58-CIFQ1 USB-Serial Conversion Cable for Computer Connection

**A personal computer connection is possible for models without communications.**

The CX-Thermo Support Software (sold separately) can be used to set parameters, monitor operation, and parameter masks. The free ThermoMini Parameter Copy Software can be used to reach E5CN parameters using communications and copy them to another E5CN to increase onsite productivity.

**Specifications:** page 7, **Dimensions:** page 13



# Model Number Structure

---

## ■ Model Number Legend

### Controllers

E5CN-□□M□-500

1 2 3 4

#### 1. Output type

R: Relay  
 Q: Voltage (for driving SSR)  
 C: Current  
 Y: Long-life relay

#### 2. Number of alarms

Blank: No alarm  
 2: Two alarms

#### 3. Option Unit

M: Option Unit can be mounted

#### 4. Input type

T: Thermocouple/platinum resistance thermometer (multi-input)  
 L: Analog input

### Option Units

E53-CN-□N

1

#### 1. Functions

H03: Communications and heater burnout/SSR failure detection  
 03: Communications  
 HB: Heater burnout/SSR failure detection and event inputs  
 B: Event inputs  
 HH03: Communications and 3-phase heater burnout/SSR failure detection  
 Q03: Communications and control output 2 (voltage output)  
 QH: Heater burnout/SSR failure detection and control output 2 (voltage output)  
 PB: External power supply for ES1B and event inputs  
 PH: External power supply for ES1B and heater burnout/SSR failure detection.

- Note:**
- The heating and cooling function is available for models with two alarm points.
  - Current transformers (CTs) are not provided with the Units. Be sure to order CTs when ordering the E5CN and the Option Units.
  - Specify the power supply specifications when ordering.

This data sheet is provided as a guideline for selecting products. Be sure to refer to the following user manuals for application precautions and other information required for operation before attempting to use the product.

E5CN/E5CN-U/AN/EN Temperature Controller User's Manual (Cat. No. H134)

E5CN/EN/AN Temperature Controller Communications User's Manual (Cat. No. H135)

# Ordering Information

## ■ Controllers with Temperature Inputs (Multi-input)

Size	Power supply voltage	Number of alarm points	Control outputs	Model
1/16 DIN 48 × 48 × 78 (W × H × D)	100 to 240 VAC	0	Relay	E5CN-RMT-500
			Voltage (for driving SSR)	E5CN-QMT-500
			Current	E5CN-CMT-500
		2	Relay	E5CN-R2MT-500
			Voltage (for driving SSR)	E5CN-Q2MT-500
			Current	E5CN-C2MT-500
	24 VAC/VDC	0	Relay	E5CN-RMT-500
			Voltage (for driving SSR)	E5CN-QMT-500
			Current	E5CN-CMT-500
		2	Relay	E5CN-R2MT-500
			Voltage (for driving SSR)	E5CN-Q2MT-500
			Current	E5CN-C2MT-500

## ■ Controllers with Analog Inputs

Size	Power supply voltage	Number of alarm points	Control outputs	Model
1/16 DIN 48 × 48 × 78 (W × H × D)	100 to 240 VAC	0	Relay	E5CN-RML-500
			Voltage (for driving SSR)	E5CN-QML-500
			Current	E5CN-CML-500
		2	Relay	E5CN-R2ML-500
			Voltage (for driving SSR)	E5CN-Q2ML-500
			Current	E5CN-C2ML-500
	24 VAC/VDC	2	Relay	E5CN-R2ML-500
			Voltage (for driving SSR)	E5CN-Q2ML-500
			Current	E5CN-C2ML-500

## ■ Option Units

The E5CN provides optional functionality when one of the following Option Units is mounted.

Functions			Model
Communications	Heater burnout/SSR failure detection		E53-CNH03N
Communications			E53-CN03N
	Heater burnout/SSR failure detection	Event inputs	E53-CNHBN
		Event inputs	E53-CNBN
Communications	3-phase heater burnout/SSR failure detection		E53-CNH03N
Communications		Control output 2 (voltage output)	E53-CNQ03N
	Heater burnout/SSR failure detection	Control output 2 (voltage output)	E53-CNQHN
		Event inputs	E53-CNPBN (See note 1.)
	Heater burnout/SSR failure detection	External power supply for ES1B	E53-CNPHN (See note 1.)

**Note: 1.** E53-CNPBN and E53-CNPHN cannot be mounted on E5CN-C□□□ (current output models).

**2.** Option Units cannot be used for Plug-in models.  
These Option Units can be used for the new E5CN models only.

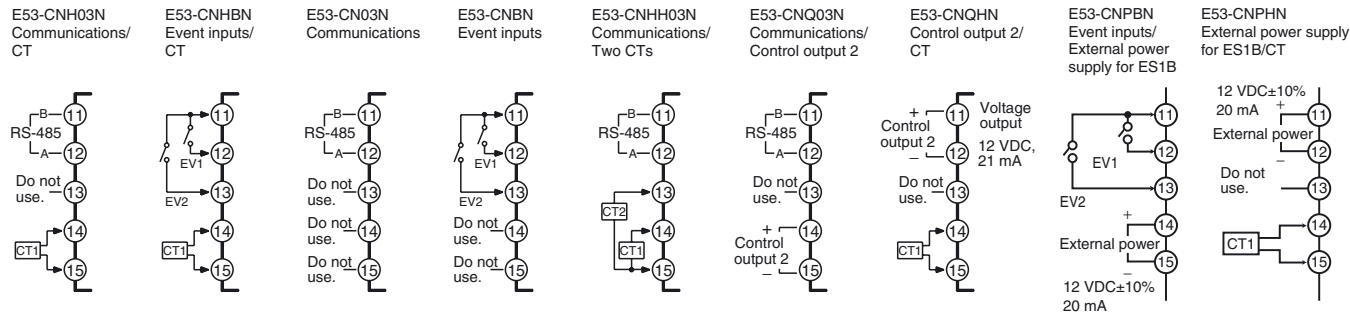

# Model Number Structure

## Model Number Legend (Plug-in-type Controllers)

E5CN-□□□□U  
1 2 3 4

### 1. Output type

R: Relay  
Q: Voltage

### 2. Number of alarms

Blank: No alarm  
1: One alarm  
2: Two alarms

### 3. Input type

T: Thermocouple/platinum resistance thermometer (multi-input)

### 4. Plug-in type

U: Plug-in type

## Ordering Information (Plug-in-type Controllers)

### Controllers with Temperature Inputs (Multi-input)

Size	Power supply voltage	Number of alarm points	Control outputs	Model
1/16 DIN	100 to 240 VAC	0	Relay	E5CN-RTU
			Voltage (for driving SSR)	E5CN-QTU
		1	Relay	E5CN-R1TU
			Voltage (for driving SSR)	E5CN-Q1TU
		2	Relay	E5CN-R2TU
			Voltage (for driving SSR)	E5CN-Q2TU
	24 VAC/VDC	0	Relay	E5CN-RTU
			Voltage (for driving SSR)	E5CN-QTU
		1	Relay	E5CN-R1TU
			Voltage (for driving SSR)	E5CN-Q1TU
		2	Relay	E5CN-R2TU
			Voltage (for driving SSR)	E5CN-Q2TU

Note: Option Units (E53-CN□□N) cannot be used for Plug-in models.

### Accessories (Order Separately)

#### USB-Serial Conversion Cable

Model
E58-CIFQ1

#### Terminal Cover

Connectable models	Terminal type
Model	E53-COV10

Note: The Terminal Cover comes with the E5CN-□□□-500 models.

#### Current Transformers (CTs)

Model	E54-CT1	E54-CT3
Hole diameter	5.8 dia.	12.0 dia.

#### Adapter

Connectable models	Terminal type
Model	Y92F-45

Note: Use this Adapter when the panel has been previously prepared for the E5B□.

#### Sockets

#### (for Models with Plug-in Connectors)

Model	P2CF-11	P2CF-11-E	P3GA-11	Y92A-48G
Type	Front-connecting Socket	Front-connecting Socket with Finger Protection	Back-connecting Socket	Terminal Cover for Finger Protection

# Specifications

## ■ Ratings

Item		Power supply voltage	100 to 240 VAC, 50/60 Hz	24 VAC, 50/60 Hz or 24 VDC
<b>Operating voltage range</b>		85% to 110% of rated supply voltage		
<b>Power consumption</b>	<b>E5CN</b>	7.5 VA max. (E5CN-R2T: 3.0 VA at 100 VAC)		5 VA/3 W max. (E5CN-R2T: 2.7 VA at 24 VAC)
	<b>E5CN-U</b>	6 VA max.		3 VA/2 W max.
<b>Sensor input</b>		<p>Models with temperature inputs</p> <p>Thermocouple: K, J, T, E, L, U, N, R, S, or B</p> <p>Platinum resistance thermometer: Pt100 or JPt100</p> <p>Infrared temperature sensor: 10 to 70°C, 60 to 120°C, 115 to 165°C, or 160 to 260°C</p> <p>Voltage input: 0 to 50 mV</p> <p>Models with analog inputs</p> <p>Current input: 4 to 20 mA or 0 to 20 mA</p> <p>Voltage input: 1 to 5 V, 0 to 5 V, or 0 to 10 V</p>		
<b>Input impedance</b>		Current input: 150 Ω, Voltage input: 1 MΩ (Use a 1:1 connection when connecting the ES2-HB.)		
<b>Control output</b>	<b>Relay output</b>	<b>E5CN</b>	SPST-NO, 250 VAC, 3 A (resistive load), electrical life: 100,000 operations, minimum applicable load: 5 V, 10 mA	
		<b>E5CN-U</b>	SPDT, 250 VAC, 3 A (resistive load), electrical life: 100,000 operations, minimum applicable load: 5 V, 10 mA	
	<b>Voltage output</b>	<b>E5CN</b> <b>E5CN-U</b>	Output voltage: 12 VDC ±15% (PNP), max. load current: 21 mA, with short-circuit protection circuit	
	<b>Current output</b>	<b>E5CN</b>	4 to 20 mA DC/0 to 20 mA DC, load: 600 Ω max., resolution: approx. 2,700	
	<b>Long-life relay output</b>	<b>E5CN</b>	SPST-NO, 250 VAC, 3 A (resistive load), electrical life: 1,000,000 operations, load power supply voltage: 75 to 250 VAC (DC loads cannot be connected.), minimum applicable load: 5 V, 10 mA, leakage current: 5 mA max. (250 VAC, 60 Hz)	
<b>Alarm output</b>		SPST-NO, 250 VAC, 1 A (resistive load), electrical life: 100,000 operations, minimum applicable load: 1 V, 1 mA		
<b>Event input</b>	<b>Contact input</b>	ON: 1 kΩ max., OFF: 100 kΩ min.		
	<b>Non-contact input</b>	ON: Residual voltage: 1.5 V max., OFF: Leakage current: 0.1 mA max.		
		Outflow current: Approx. 7 mA per point		
<b>External power supply for ES1B</b>		12 VDC ±10%, 20 mA, Short-circuit protection provided.		
<b>Control method</b>		ON/OFF control or 2-PID control (with auto-tuning)		
<b>Setting method</b>		Digital setting using front panel keys		
<b>Indication method</b>		11-segment digital display and individual indicators (7-segments displays also possible) Character height: PV: 11 mm, SV: 6.5 mm		
<b>Other functions</b>		Manual output, heating/cooling control, transfer output (on some models), loop break alarm, multi SP, MV limiter, input digital filter, self-tuning, temperature input shift, run/stop, protection functions, etc.		
<b>Ambient operating temperature</b>		-10 to 55°C (with no icing or condensation), for 3-year warranty: -10 to 50°C		
<b>Ambient operating humidity</b>		25% to 85%		
<b>Storage temperature</b>		-25 to 65°C (with no icing or condensation)		





## Alarm Types

Select alarm types out of the 12 alarm types listed in the following table.

Set value	Alarm type	Alarm output operation	
		When X is positive	When X is negative
0	Alarm function OFF	Output OFF	
1 (See note 1.)	Upper- and lower-limit		(See note 2.)
2	Upper limit		
3	Lower limit		
4 (See note 1.)	Upper- and lower-limit range		(See note 3.)
5 (See note 1.)	Upper- and lower-limit with standby sequence		(See note 4.)
6	Upper-limit with standby sequence		
7	Lower-limit with standby sequence		
8	Absolute-value upper-limit		
9	Absolute-value lower-limit		
10	Absolute-value upper-limit with standby sequence		
11	Absolute-value lower-limit with standby sequence		
12 (See note 6.)	LBA (for alarm 1 only)	---	

**Note: 1.** With set values 1, 4 and 5, the upper and lower limit values can be set independently for each alarm type, and are expressed as “L” and “H.”

**2.** Set value: 1, Upper- and lower-limit alarm

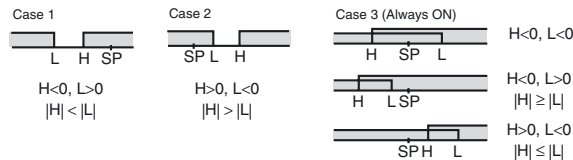

**3.** Set value: 4, Upper- and lower-limit range

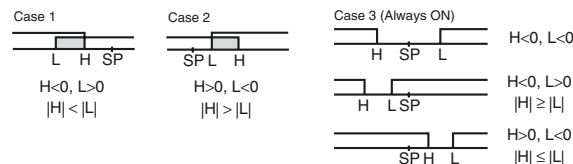

**4.** Set value: 5, Upper- and lower-limit with standby sequence  
For Upper- and Lower-Limit Alarm Described Above

• Case 1 and 2

Always OFF when the upper-limit and lower-limit hysteresis overlaps.

• Case 3: Always OFF

**5.** Set value: 5, Upper- and lower-limit with standby sequence  
Always OFF when the upper-limit and lower-limit hysteresis overlaps.

**6.** Set value: 12, LBA can be set only for alarm 1.

Set the alarm types for alarms 1 to 3 independently in the initial setting level. The default setting is 2 (upper limit).

## ■ Characteristics

<b>Indication accuracy</b>	Thermocouple: (See note 1.) E5CN: (±0.5% of indicated value or ±1°C, whichever is greater) ±1 digit max. E5CN-U: (±1% of indicated value or ±2°C, whichever is greater) ±1 digit max. Platinum resistance thermometer: (±0.5% of indicated value or ±1°C, whichever is greater) ±1 digit max. Analog input: ±0.5% FS ±1 digit max. CT input: ±5% FS ±1 digit max.	
<b>Influence of temperature (See note 2.)</b>	R, S, and B thermocouple inputs: (±1% of PV or ±10°C, whichever is greater) ±1 digit max. Other thermocouple inputs: (±1% of PV or ±4°C, whichever is greater) ±1 digit max. Platinum resistance thermometer inputs: (±1% of PV or ±2°C, whichever is greater) ±1 digit max. Analog inputs: (±1% of FS) ±1 digit max.	
<b>Influence of voltage (See note 2.)</b>		
<b>Hysteresis</b>	Models with thermocouple/platinum resistance thermometer (multi-input) input: 0.1 to 999.9 EU (in units of 0.1 EU) Models with analog input: 0.01 to 99.99% FS (in units of 0.01% FS)	
<b>Proportional band (P)</b>	Models with thermocouple/platinum resistance thermometer (multi-input) input: 0.1 to 999.9 EU (in units of 0.1 EU) Models with analog input: 0.1 to 999.9% FS (in units of 0.1% FS)	
<b>Integral time (I)</b>	0 to 3999 s (in units of 1 s)	
<b>Derivative time (D)</b>	0 to 3999 s (in units of 1 s) (See note 3.)	
<b>Control period</b>	0.5, 1 to 99 s (in units of 1 s)	
<b>Manual reset value</b>	0.0 to 100.0% (in units of 0.1%)	
<b>Alarm setting range</b>	-1999 to 9999 (decimal point position depends on input type)	
<b>Sampling period</b>	250 ms	
<b>Affect of signal source resistance</b>	Thermocouple: 0.1°C/Ω max. (100 Ω max.) (See note 4.) Platinum resistance thermometer: 0.4°C/Ω max. (10 Ω max.)	
<b>Insulation resistance</b>	20 MΩ min. (at 500 VDC)	
<b>Dielectric strength</b>	2,000 VAC, 50 or 60 Hz for 1 min (between terminals with different charge)	
<b>Vibration resistance</b>	<b>Malfunction</b>	10 to 55 Hz, 20 m/s <sup>2</sup> for 10 min each in X, Y, and Z directions
	<b>Destruction</b>	10 to 55 Hz, 0.75-mm single amplitude for 2 hrs each in X, Y, and Z directions
<b>Shock resistance</b>	<b>Malfunction</b>	100 m/s <sup>2</sup> min., 3 times each in X, Y, and Z directions
	<b>Destruction</b>	300 m/s <sup>2</sup> min., 3 times each in X, Y, and Z directions
<b>Weight</b>	<b>E5CN</b>	Controller: Approx. 150 g, Mounting Bracket: Approx. 10 g
	<b>E5CN-U</b>	Controller: Approx. 110 g, Mounting Bracket: Approx. 10 g
<b>Degree of protection</b>	<b>E5CN</b>	Front panel: NEMA4X for indoor use (equivalent to IP66) Rear case: IP20, Terminal section: IP00
	<b>E5CN-U</b>	Front panel: Equivalent to IP50, rear case: IP20, terminals: IP00
<b>Memory protection</b>	Non-volatile memory (number of writes: 1,000,000 operations)	
<b>EMC</b>	Emission Enclosure: EN55011 Group1 Class A Emission AC Mains: EN55011 Group1 Class A Immunity ESD: EN61000-4-2 4 kV contact discharge (level 2) 8 kV air discharge (level 3) Immunity RF-interference: EN61000-4-3 10 V/m (80-1000 MHz, 1.4-2.0 GHz amplitude modulated) (level 3) 10 V/m (900 MHz pulse modulated) Immunity Conducted Disturbance: EN61000-4-6 3 V (0.15 to 80 MHz) (level 2) Immunity Burst: EN61000-4-4 2 kV Power-line (level 3) 1 kV I/O signal-line (level 3) Immunity Surge: EN61000-4-5 1kV line to line Power line, output line (relay output) 2 kV line to ground Power line, output line (relay output) 1 kV line to ground Input line (communication) Immunity Voltage Dip/Interrupting: EN61000-4-11 0.5 cycle, 100% (rated voltage)	
<b>Approved standards</b>	UL 61010C-1 CSA C22.2 No.1010.1	
<b>Conformed standards</b>	EN61326, EN61010-1, IEC61010-1 VDE0106 Part 100 (Finger protection), when the terminal cover is mounted.	

- Note:**
- The indication accuracy of K thermocouples in the -200 to 1300°C range, T and N thermocouples at a temperature of -100°C max., and U and L thermocouples at any temperature is ±2°C ±1 digit maximum. The indication accuracy of the B thermocouple at a temperature of 400°C max. is not specified. The indication accuracy of the R and S thermocouples at a temperature of 200°C max. is ±3°C ±1 digit max.
  - “EU” stands for Engineering Unit and is used as the unit after scaling. For a temperature sensor, the EU is °C or °F.
  - When robust tuning (RT) is ON, the differential time is 0.0 to 999.9 (in units of 0.1 s).
  - B, R, and S sensors: 0.2°C/Ω max. (100 Ω max.)

## ■ USB-Serial Conversion Cable

<b>Applicable OS</b>	Windows 2000/XP
<b>Applicable software</b>	Thermo Mini, CX-Thermo
<b>Applicable models</b>	E5CN/E5CN-U/E5AN/E5EN
<b>USB interface standard</b>	Conforms to USB Specification 1.1.
<b>DTE speed</b>	38400 bps
<b>Connector specifications</b>	Computer: USB (type A plug) Temperature Controller: Serial
<b>Power supply</b>	Bus power (Supplied from USB host controller.)
<b>Power supply voltage</b>	5 VDC
<b>Current consumption</b>	70 mA
<b>Ambient operating temperature</b>	0 to 55°C (with no condensation or icing)
<b>Ambient operating humidity</b>	10% to 80%
<b>Storage temperature</b>	-20 to 60°C (with no condensation or icing)
<b>Storage humidity</b>	10% to 80%
<b>Altitude</b>	2,000 m max.
<b>Weight</b>	Approx. 100 g

**Note:** A driver must be installed in the personal computer. Refer to installation information in the operation manual for the Conversion Cable.

## ■ Communications Specifications

<b>Transmission line connection method</b>	RS-485 multipoint
<b>Communications</b>	RS-485 (two-wire, half duplex)
<b>Synchronization method</b>	Start-stop synchronization
<b>Baud rate</b>	1200, 2400, 4800, 9600, 19200, or 38400 bps
<b>Transmission code</b>	ASCII
<b>Data bit length</b>	7 or 8 bits
<b>Stop bit length</b>	1 or 2 bits
<b>Error detection</b>	Vertical parity (none, even, odd) Frame check sequence (FCS) with SYSWAY Block check character (BCC) with CompoWay/F or CRC-16 Modbus
<b>Flow control</b>	None
<b>Interface</b>	RS-485
<b>Retry function</b>	None
<b>Communications buffer</b>	40 bytes
<b>Communications response wait time</b>	0 to 99 ms Default: 20 ms

**Note:** The baud rate, data bit length, stop bit length, and vertical parity can be individually set using the Communications Setting Level.

## ■ Current Transformer (Sold Separately)

### Ratings

Dielectric strength	1,000 VAC for 1 min
Vibration resistance	50 Hz, 98 m/s <sup>2</sup>
Weight	E54-CT1: Approx. 11.5 g, E54-CT3: Approx. 50 g
Accessories (E54-CT3 only)	Armatures (2) Plugs (2)

## ■ Heater Burnout Alarms and SSR Failure Detection Alarms

Maximum heater current	50 A AC
Input current indication accuracy	±5% FS ±1 digit max.
Heater burnout alarm setting range	0.1 to 49.9 A (in units of 0.1 A) 0.0 A: Heater burnout/SSR failure alarm output turned OFF. 50.0 A: Heater burnout/SSR failure alarm output turned ON. Minimum detection ON time: 190 ms (See note 1.)
SSR failure detection alarm setting range	0.1 to 49.9 A (in units of 0.1 A) 0.0 A: Heater burnout/SSR failure alarm output turned ON. 50.0 A: Heater burnout/SSR failure alarm output turned OFF. Minimum detection OFF time: 190 ms (See note 2.)

- Note:** 1. If the ON time of control output 1 is less than 190 ms, heater burnout detection and the heater current will not be measured.  
2. If the OFF time of control output 1 is less than 190 ms, SSR failure detection and the heater current will not be measured.

## ■ Electrical Life Expectancy Curve for Relays (Reference Values)

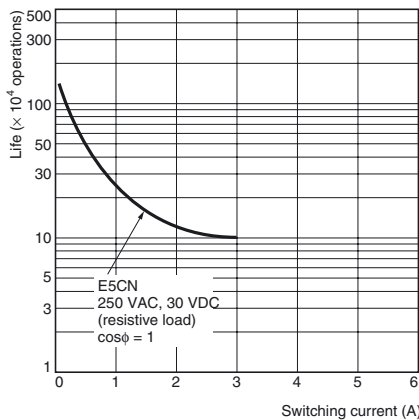

**Note:** Do not connect a DC load to a Controller with a Long-life Relay Output.

## E54-CT1 Thru-current (Io) vs. Output Voltage (Eo) (Reference Values)

Maximum continuous heater current: 50 A (50/60 Hz)  
Number of windings: 400±2  
Winding resistance: 18±2 Ω

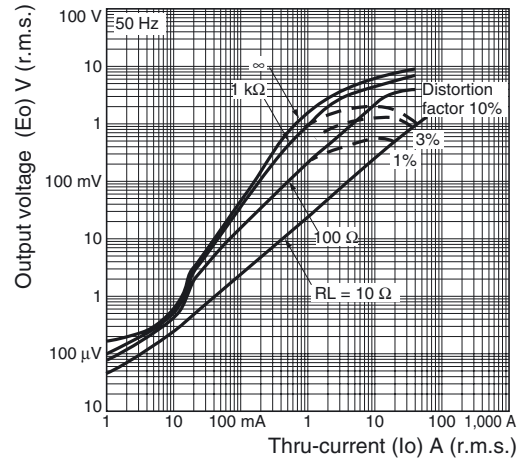

## E54-CT3 Thru-current (Io) vs. Output Voltage (Eo) (Reference Values)

Maximum continuous heater current: 120 A (50/60 Hz)  
(Maximum continuous heater current for an OMRON Temperature Controller is 50 A.)  
Number of windings: 400±2  
Winding resistance: 8±0.8 Ω

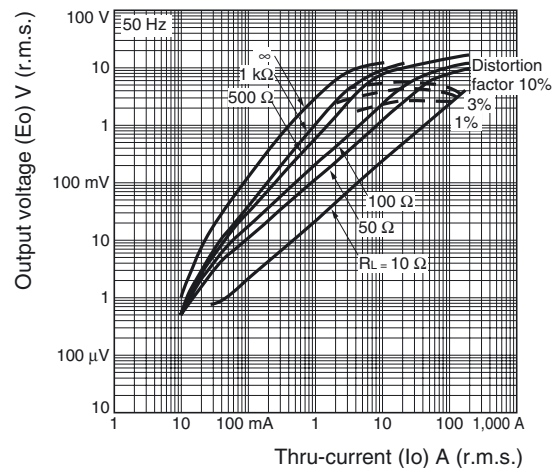

# External Connections

- A voltage output (control output) is not electrically insulated from the internal circuits. When using a grounding thermocouple, do not connect any of the control output terminals to ground. If the control output terminals are connected to ground, errors will occur in the measured temperature values as a result of leakage current.
- Standard insulation is applied between any of the following: power supply terminals, input terminals, output terminals, and communications terminals (for models with communications). If reinforced insulation is required, provide additional insulation, such as spacial distance or material insulation, as defined by IEC 60664 suitable for the maximum operating voltage.
- Consult with your OMRON representative before using the external power supply for the ES1B for any other purpose.

## E5CN

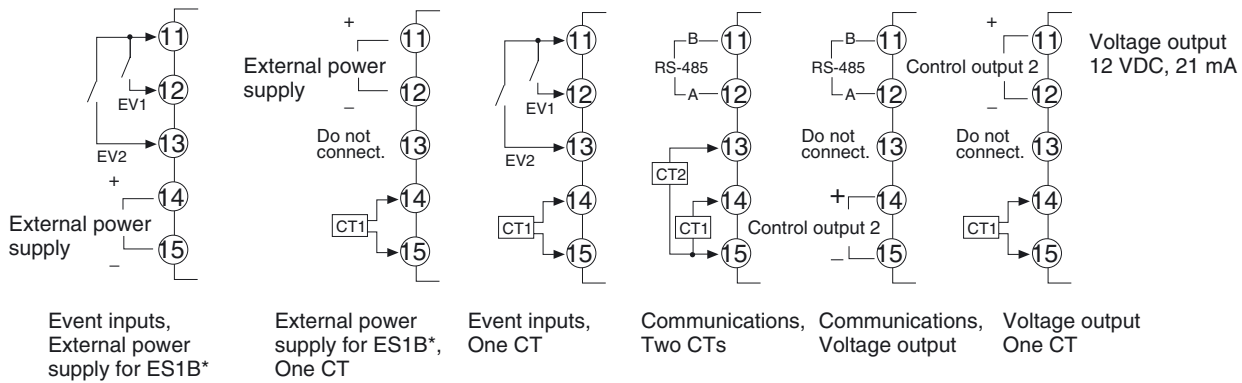
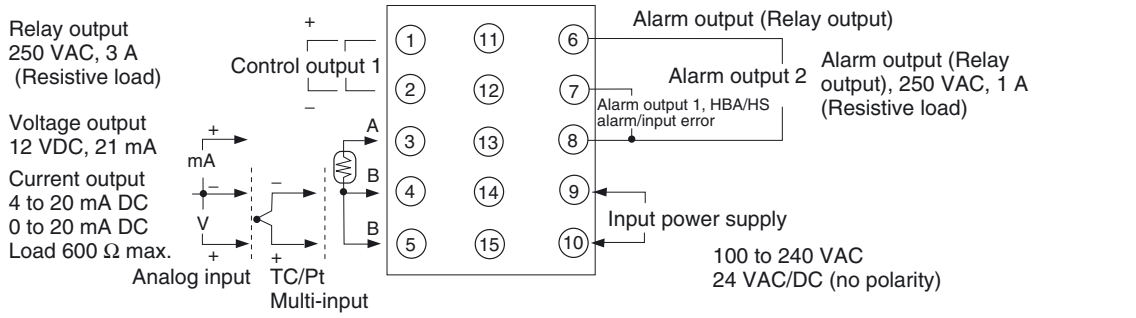

## E5CN-U

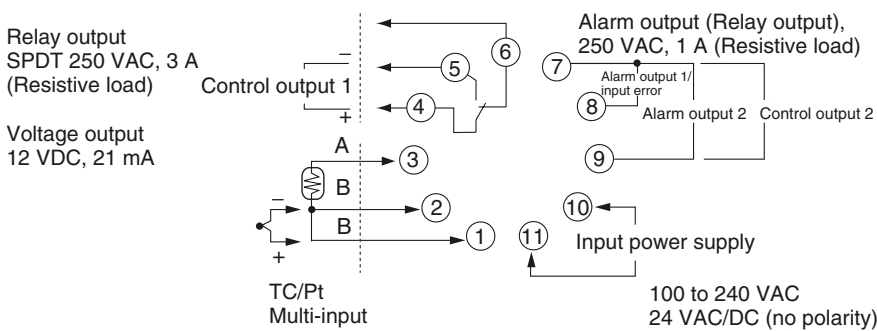

# Nomenclature

E5CN  
E5CN-U

The front panel is the same for the E5CN and E5CN-U.

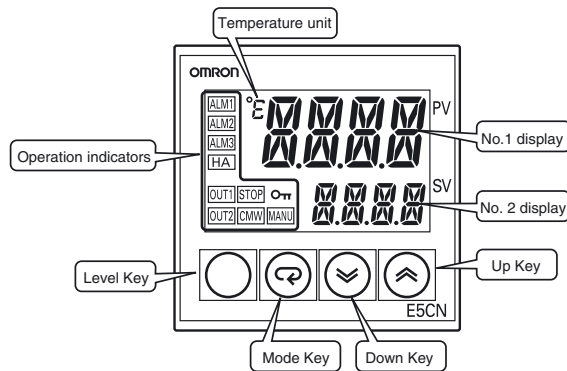

# Dimensions

E5CN  
Terminal Models

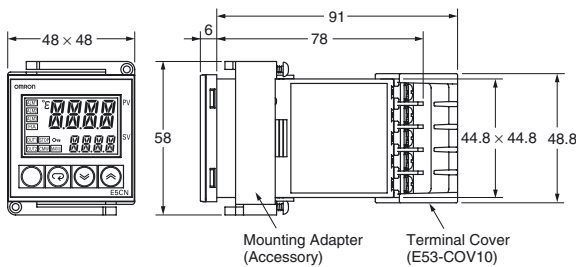

**Note:** The terminal block cannot be removed.  
The suffix "-500" is added to the model number of each Controller provided with a E53-COV10 Terminal Cover.

### Panel Cutout

Mounted Separately

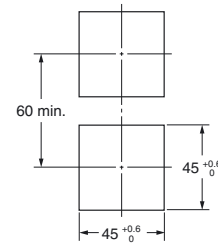

Group Mounted

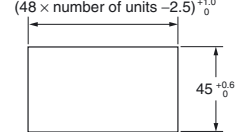

- Group mounting does not allow waterproofing.
- Recommended panel thickness is 1 to 5 mm.
- Group mounting is not possible in the vertical direction. (Maintain the specified mounting space between Controllers.)
- To mount the Controller so that it is waterproof, insert the waterproof packing onto the Controller.
- When two or more Controllers are mounted, make sure that the surrounding temperature does not exceed the allowable operating temperature specified in the specifications.

E5CN-U  
Plug-in Models

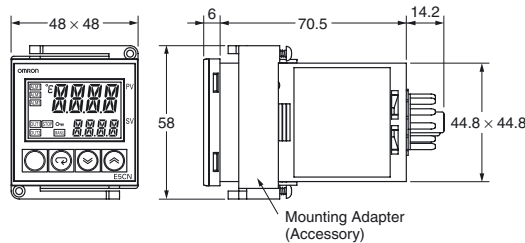
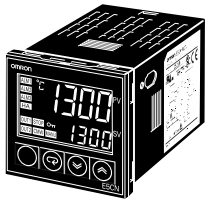

### Panel Cutout

Mounted Separately

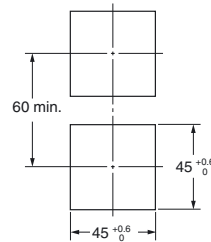

Group Mounted



- Recommended panel thickness is 1 to 5 mm.
- Group mounting is not possible in the vertical direction. (Maintain the specified mounting space between Controllers.)
- When two or more Controllers are mounted, make sure that the surrounding temperature does not exceed the allowable operating temperature specified in the specifications.

## ■ Accessories

### USB-Serial Conversion Cable (Sold Separately)

E58-CIFQ1

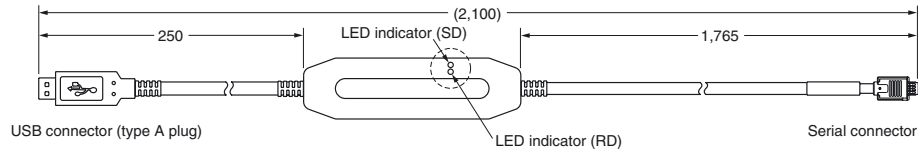
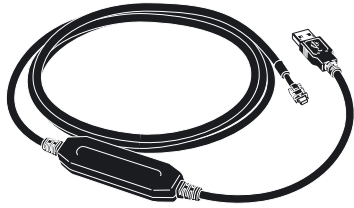

### Terminal Cover

E53-COV10

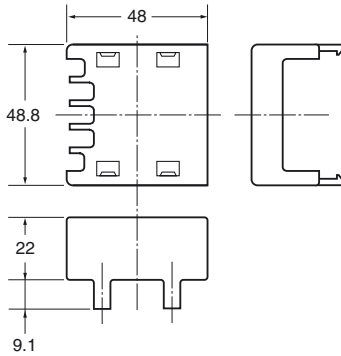
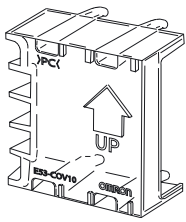

**Note:** The suffix "-500" is added to the model number of each Controller provided with a E53-COV10 Terminal Cover.

### Current Transformers (Sold Separately)

E54-CT1

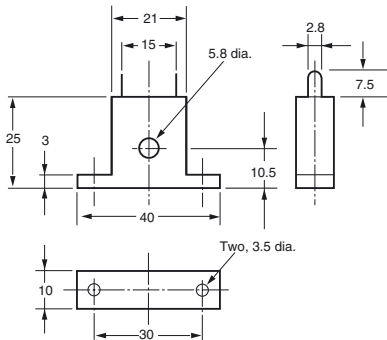
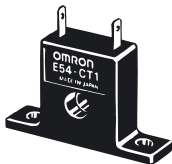

E54-CT3

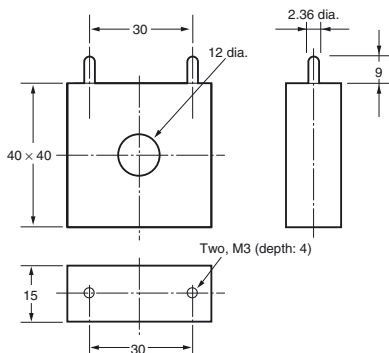

#### E54-CT3 Accessory

##### • Armature

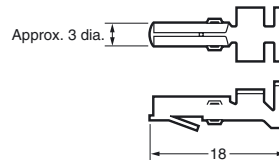

##### • Plug



#### Connection Example

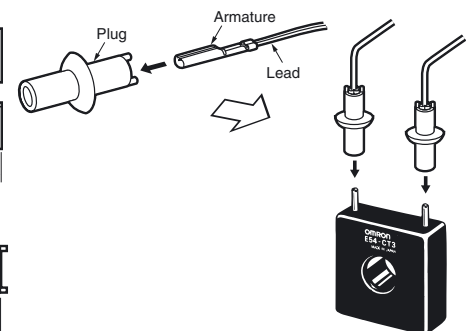

## Adapter (Sold Separately)

**Note:** Use this Adapter when the panel has already been prepared for the E5B□.

Y92F-45

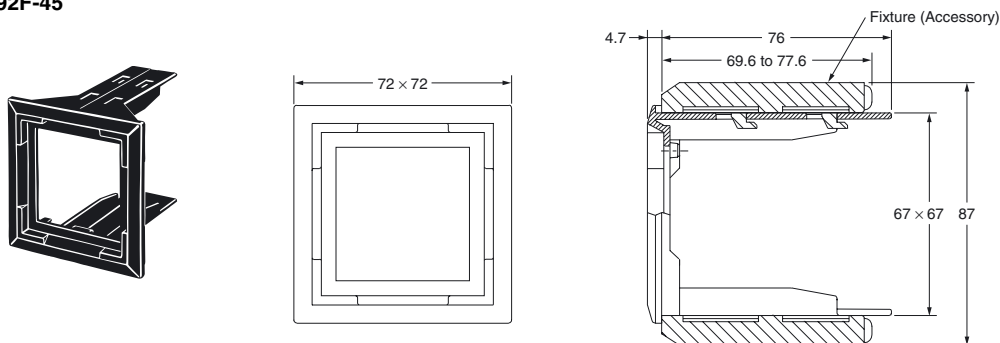

Mounted to E5CN

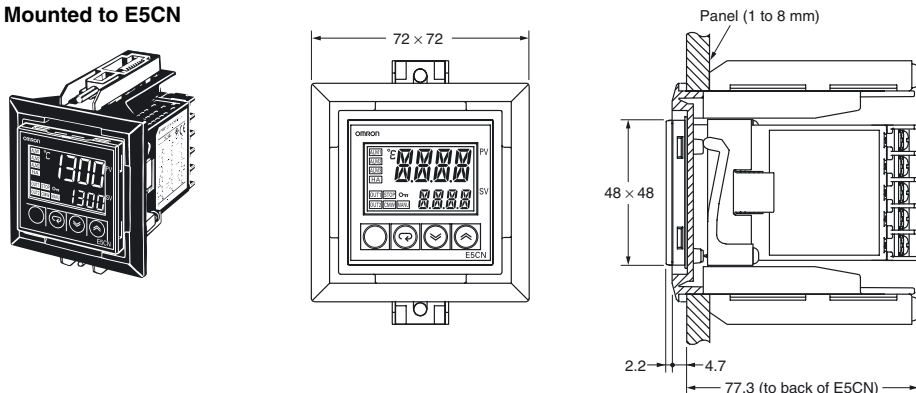

## E5CN-U Wiring Socket (Sold Separately)

Front-connecting Socket

P2CF-11

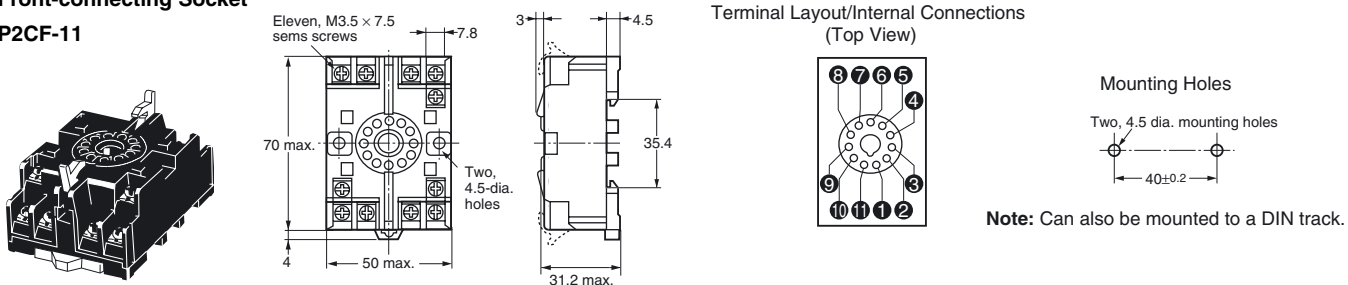

**Note:** A model with finger protection (P2CF-11-E) is also available.

Back-connecting Socket

P3GA-11

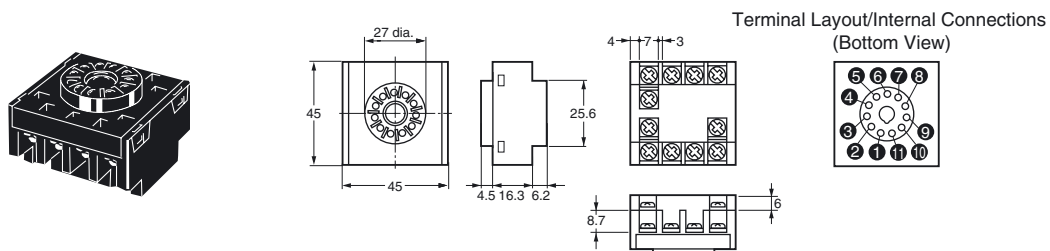

**Note:** 1. Using any other sockets will adversely affect accuracy. Use only the specified sockets.  
2. A Protective Cover for finger protection (Y92A-48G) is also available.

## Digital Temperature Controllers E5EN

**This Best-selling General-purpose Temperature Controller Is Now Even Better. USB-Serial Conversion Cable and Support Software Are Also Available.**

- Controllers now available with analog inputs.
- Faster sampling at 250 ms.
- Transfer output provided for easy output to recorders.
- Voltage outputs (to drive SSRs) for both heating and cooling control.
- Models available with three-phase heater burnout detection and SSR fault detection.
- Manual output provided.
- Controller available with long-life relay output.
- Models available with external power supply for ES1B Infrared Thermosensor.
- Easy setting with 11-segment displays.
- Connect to either a thermocouple or platinum resistance thermometer with the same model.
- Easily see the status from a distance with PV display with three-color switching function.

**Note:** Refer to Precautions on page 43.



**NEW**

**Note:** Refer to page 40 for information on changes in comparison to previous models.

## Features

### Improved Functions for a Wider Range of Application

#### Control Analog Values, such as Pressures, Flowrates, and Levels

The E5EN Series now also includes models that accept analog inputs, enabling control applications other than for temperature, including pressure, flowrate, level, humidity, and weight control.

#### Faster Sampling at 250 ms

The previous sampling time of 500 ms has been reduced by half to 250 ms. This enables the E5EN to handle application requiring even greater response speed and accuracy.

#### Easy Connector to a Recorder

A transfer output now makes it easy to connect to a recorder or PLC Analog I/O Unit.

#### Voltage Outputs (to Drive SSRs) for Both Heating and Cooling Control.

Voltage outputs can be used for both heating and cooling for Models with Two Control Outputs.

#### Three-phase Heater Burnout Detection

With Models with Three-phase Heater Burnout and SSR Failure Detection, two current transformers can be connected to detect both heater burnout and SSR failure at the same time, reducing costs because a separate heater burnout alarm device is not required. SSR failure detection can be used even with Models with Single-phase Heater Burnout Alarms.

### E58-CIFQ1 USB-Serial Conversion Cable for Computer Connection

**A personal computer connection is possible for models without communications.**

The CX-Thermo Support Software (sold separately) can be used to set parameters, monitor operation, and parameter masks. (CX-Thermo support of the E5EN is scheduled for March 2005.)

**Specifications: page 19, Dimensions: page 25**





# Model Number Structure

## Model Number Legend

E5EN-□□□M□-500  
 1 2 3 4 5

**1. Output 1 type**

- R: Relay
- Q: Voltage for driving SSR
- C: Current

**2. Number of alarms**

3: 3 alarms

**3. Fixed option**

- H: Heater burnout/SSR failure detection (1 CT)
- HH: Heater burnout/SSR failure detection (2 CT)
- Q: Voltage for driving SSR
- Y: Long-life Relay
- P: External Power supply for ES1B
- Blank: Not available

**4. Option Unit**

**5. Input type**

- T: Thermocouple/platinum resistance thermometer (multi-input)
- L: Analog input

## Ordering Information

### Temperature Input (Multi Input) Standard Models

Size	Power supply voltage	Number of alarm points	Control output	Heater alarm	Model
1/8 DIN 48 × 96 × 78 (W × H × D)	100 to 240 VAC	3	Relay	No	E5EN-R3MT-500
				Yes (1 CT)	E5EN-R3HMT-500
				Yes (2 CT)	E5EN-R3HHMT-500
			Voltage (for driving SSR)	No	E5EN-Q3MT-500
				Yes (1 CT)	E5EN-Q3HMT-500
				Yes (2 CT)	E5EN-Q3HHMT-500
	24 VAC/VDC	3	Relay	No	E5EN-R3MT-500
				Yes (1 CT)	E5EN-R3HMT-500
				Yes (2 CT)	E5EN-R3HHMT-500
			Voltage (for driving SSR)	No	E5EN-Q3MT-500
				Yes (1 CT)	E5EN-Q3HMT-500
				Yes (2 CT)	E5EN-Q3HHMT-500
Current	No	E5EN-C3MT-500			
	Yes (1 CT)	E5EN-C3HMT-500			
	Yes (2 CT)	E5EN-C3HHMT-500			

### Temperature Input (Multi Input) 2 Outputs Models

Size	Power supply voltage	Number of alarm points	Control output 1	Control output 2	Power supply for ES1B	Model	
1/8 DIN 48 × 96 × 78 (W × H × D)	100 to 240 VAC	3	Relay	Voltage (for driving SSR)	No	E5EN-R3QMT-500	
				Voltage (for driving SSR)		Voltage (for driving SSR)	E5EN-Q3QMT-500
						Ling-life Relay	E5EN-Q3YMT-500
			Current	Voltage (for driving SSR)		E5EN-C3QMT-500	
				Ling-life Relay		E5EN-C3YMT-500	
			Relay	No		Yes	E5EN-R3PMT-500
					Voltage (for driving SSR)		E5EN-Q3PMT-500

## ■ Analog Input Models

Size	Power supply voltage	Number of alarm points	Control output 1	Heater alarm	Control output 2	Model
1/8 DIN 48 × 96 × 78 (W × H × D)	100 to 240 VAC	3	Relay	No	No	E5EN-R3ML-500
			Voltage (for driving SSR)	No		E5EN-Q3ML-500
			Current	No		E5EN-C3ML-500
			Relay	Yes (1 CT)		E5EN-R3HML-500
			Voltage (for driving SSR)	Yes (1 CT)		E5EN-Q3HML-500
			Voltage (for driving SSR)	No	Long-life Relay	E5EN-Q3YML-500

## ■ Option Units

Name	Function	Model
Communication Unit	RS-232C Communication	E53-EN01
	RS-485 Communication	E53-EN03
Event Input Unit	Event Input	E53-AKB

# Specifications











## ■ Ratings

Item	Power supply voltage	100 to 240 VAC, 50/60 Hz	24 VAC, 50/60 Hz or 24 VDC
<b>Operating voltage range</b>		85% to 110% of rated supply voltage	
<b>Power consumption</b>		Approx. 10 VA	Approx. 5.5 VA (24 VAC)/approx. 4 W (24 VDC)
<b>Sensor input</b>		Models with temperature inputs Thermocouple: K, J, T, E, L, U, N, R, S, or B Platinum resistance thermometer: Pt100 or JPt100 Infrared temperature sensor: 10 to 70°C, 60 to 120°C, 115 to 165°C, or 160 to 260°C Voltage input: 0 to 50 mV Models with analog inputs Current input: 4 to 20 mA or 0 to 20 mA Voltage input: 1 to 5 V, 0 to 5 V, or 0 to 10 V	
<b>Input impedance</b>		Current input: 150 Ω, Voltage input: 1 MΩ (Use a 1:1 connection when connecting the ES2-HB.)	
<b>Control output</b>	<b>Relay output</b>	SPST-NO, 250 VAC, 5 A (resistive load), electrical life: 100,000 operations, minimum applicable load: 5 V, 10 mA	
	<b>Voltage output</b>	Output voltage: 12 VDC +15%/–20% (PNP), max. load current: 40 mA, with short-circuit protection circuit (max. load current of control output 2: 21 mA)	
	<b>Current output</b>	4 to 20 mA DC/0 to 20 mA DC, load: 600 Ω max., resolution: approx. 2,700	
	<b>Long-life relay output</b>	SPST-NO, 250 VAC, 3 A (resistive load), electrical life: 1,000,000 operations, load power supply voltage: 75 to 250 VAC (DC loads cannot be connected.), minimum applicable load: 5 V, 10 mA, leakage current: 5 mA max. (250 VAC, 60 Hz)	
<b>Alarm output</b>		SPST-NO, 250 VAC, 3 A (resistive load), electrical life: 100,000 operations, minimum applicable load: 1 V, 1 mA	
<b>Event input</b>	<b>Contact input</b>	ON: 1 kΩ max., OFF: 100 kΩ min.	
	<b>Non-contact input</b>	ON: Residual voltage: 1.5 V max., OFF: Leakage current: 0.1 mA max.	
		Outflow current: Approx. 7 mA per point	
<b>External power supply for ES1B</b>		12 VDC ±10%, 20 mA, Short-circuit protection provided.	
<b>Control method</b>		ON/OFF control or 2-PID control (with auto-tuning)	
<b>Setting method</b>		Digital setting using front panel keys	
<b>Indication method</b>		11-segment digital display and individual indicators (7-segments displays also possible) Character height: PV: 14 mm, SV: 9.5 mm	
<b>Other functions</b>		Manual output, heating/cooling control, transfer output (on some models), loop break alarm, multi SP, MV limiter, input digital filter, self-tuning, temperature input shift, run/stop, protection functions, etc.	
<b>Ambient operating temperature</b>		–10 to 55°C (with no icing or condensation), for 3-year warranty: –10 to 50°C	
<b>Ambient operating humidity</b>		25% to 85%	
<b>Storage temperature</b>		–25 to 65°C (with no icing or condensation)	

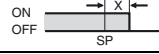
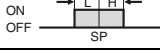

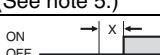
## Alarm Types

Select alarm types out of the 12 alarm types listed in the following table.

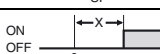
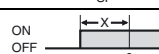
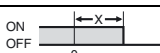
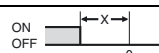
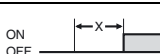
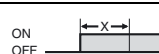
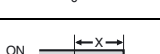
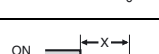
Set value	Alarm type	Alarm output operation	
		When X is positive	When X is negative
0	Alarm function OFF	Output OFF	
1 (See note 1.)	Upper- and lower-limit		(See note 2.)
2	Upper limit		
3	Lower limit		
4 (See note 1.)	Upper- and lower-limit range		(See note 3.)
5 (See note 1.)	Upper- and lower-limit with standby sequence		(See note 4.)
6	Upper-limit with standby sequence		
7	Lower-limit with standby sequence		
8	Absolute-value upper-limit		
9	Absolute-value lower-limit		
10	Absolute-value upper-limit with standby sequence		
11	Absolute-value lower-limit with standby sequence		
12 (See note 6.)	LBA (for alarm 1 only)	---	

**Note: 1.** With set values 1, 4 and 5, the upper and lower limit values can be set independently for each alarm type, and are expressed as “L” and “H.”

**2.** Set value: 1, Upper- and lower-limit alarm

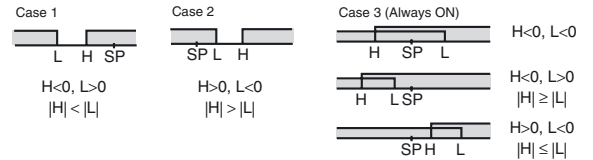

**3.** Set value: 4, Upper- and lower-limit range

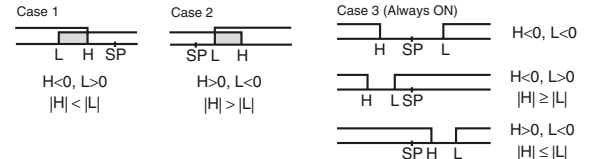

**4.** Set value: 5, Upper- and lower-limit with standby sequence  
For Upper- and Lower-Limit Alarm Described Above

- Case 1 and 2

Always OFF when the upper-limit and lower-limit hysteresis overlaps.

- Case 3: Always OFF

**5.** Set value: 5, Upper- and lower-limit with standby sequence  
Always OFF when the upper-limit and lower-limit hysteresis overlaps.

**6.** Set value: 12, LBA can be set only for alarm 1.

Set the alarm types for alarms 1 to 3 independently in the initial setting level. The default setting is 2 (upper limit).

## ■ Characteristics

<b>Indication accuracy</b>	Thermocouple: (See note 1.) (±0.5% of indicated value or ±1°C, whichever is greater) ±1 digit max. Platinum resistance thermometer: (±0.5% of indicated value or ±1°C, whichever is greater) ±1 digit max. Analog input: ±0.5% FS ±1 digit max. CT input: ±5% FS ±1 digit max.
<b>Influence of temperature (See note 2.)</b>	R, S, and B thermocouple inputs: (±1% of PV or ±10°C, whichever is greater) ±1 digit max. Other thermocouple inputs: (±1% of PV or ±4°C, whichever is greater) ±1 digit max. ±10°C for -100°C or less for K sensors Platinum resistance thermometer inputs: (±1% of PV or ±2°C, whichever is greater) ±1 digit max. Analog inputs: (±1% of FS) ±1 digit max.
<b>Influence of voltage (See note 2.)</b>	
<b>Hysteresis</b>	Models with thermocouple/platinum resistance thermometer (multi-input) input: 0.1 to 999.9 EU (in units of 0.1 EU) (See note 3.) Models with analog input: 0.01 to 99.99% FS (in units of 0.01% FS)
<b>Proportional band (P)</b>	Models with thermocouple/platinum resistance thermometer (multi-input) input: 0.1 to 999.9 EU (in units of 0.1 EU) (See note 3.) Models with analog input: 0.1 to 999.9% FS (in units of 0.1% FS)
<b>Integral time (I)</b>	0 to 3999 s (in units of 1 s)
<b>Derivative time (D)</b>	0 to 3999 s (in units of 1 s) (See note 4.)
<b>Control period</b>	0.5, 1 to 99 s (in units of 1 s)
<b>Manual reset value</b>	0.0 to 100.0% (in units of 0.1%)
<b>Alarm setting range</b>	-1999 to 9999 (decimal point position depends on input type)
<b>Sampling period</b>	250 ms
<b>Affect of signal source resistance</b>	Thermocouple: 0.1°C/Ω max. (100 Ω max.) (See note 5.) Platinum resistance thermometer: 0.4°C/Ω max. (10 Ω max.)
<b>Insulation resistance</b>	20 MΩ min. (at 500 VDC)
<b>Dielectric strength</b>	2,000 VAC, 50 or 60 Hz for 1 min (between terminals with different charge)
<b>Vibration resistance</b>	<b>Malfunction</b>
	<b>Destruction</b>
<b>Shock resistance</b>	<b>Malfunction</b>
	<b>Destruction</b>
<b>Weight</b>	Controller: Approx. 260 g, Mounting Bracket: Approx. 100 g
<b>Degree of protection</b>	Front panel: NEMA4X for indoor use (equivalent to IP66) Rear case: IP20, Terminal section: IP00
<b>Memory protection</b>	Non-volatile memory (number of writes: 1,000,000 operations)
<b>EMC</b>	Emission Enclosure: EN55011 Group1 Class A Emission AC Mains: EN55011 Group1 Class A Immunity ESD: EN61000-4-2 4 kV contact discharge (level 2) 8 kV air discharge (level 3) Immunity RF-interference: EN61000-4-3 10 V/m (80-1000 MHz, 1.4-2.0 GHz amplitude modulated) (level 3) 10 V/m (900 MHz pulse modulated) Immunity Conducted Disturbance: EN61000-4-6 3 V (0.15 to 80 MHz) (level 2) EN61000-4-4 2 kV Power-line (level 3) 1 kV I/O signal-line (level 3) Immunity Surge: EN61000-4-5 1kV line to line Power line, output line (relay output) 2 kV line to ground Power line, output line (relay output) 1 kV line to ground Input line (communication) Immunity Voltage Dip/Interrupting: EN61000-4-11 0.5 cycle, 100% (rated voltage)
<b>Approved standards</b>	UL 61010C-1 CSA C22.2 No.1010.1
<b>Conformed standards</b>	EN61326, EN61010-1, IEC61010-1 VDE0106 Part 100 (Finger protection), when the terminal cover is mounted.

**Note: 1.** The indication accuracy of K thermocouples in the -200 to 1300°C range, T and N thermocouples at a temperature of -100°C max., and U and L thermocouples at any temperature is ±2°C ±1 digit maximum. The indication accuracy of the B thermocouple at a temperature of 400°C max. is not specified. The indication accuracy of the R and S thermocouples at a temperature of 200°C max. is ±3°C ±1 digit max.

- Conditions: Ambient temperature: -10°C to 23°C to 55°C, Voltage range: -15% to +10% of rated voltage
- “EU” stands for Engineering Unit and is used as the unit after scaling. For a temperature sensor, the EU is °C or °F.
- When robust tuning (RT) is ON, the differential time is 0.0 to 999.9 (in units of 0.1 s).
- B, R, and S sensors: 0.2°C/Ω max. (100 Ω max.)

## ■ USB-Serial Conversion Cable

<b>Applicable OS</b>	Windows 2000/XP
<b>Applicable software</b>	Thermo Mini, CX-Thermo
<b>Applicable models</b>	E5CN/E5CN-U/E5AN/E5EN
<b>USB interface standard</b>	Conforms to USB Specification 1.1.
<b>DTE speed</b>	38400 bps
<b>Connector specifications</b>	Computer: USB (type A plug) Temperature Controller: Serial
<b>Power supply</b>	Bus power (Supplied from USB host controller.)
<b>Power supply voltage</b>	5 VDC
<b>Current consumption</b>	70 mA
<b>Ambient operating temperature</b>	0 to 55°C (with no condensation or icing)
<b>Ambient operating humidity</b>	10% to 80%
<b>Storage temperature</b>	-20 to 60°C (with no condensation or icing)
<b>Storage humidity</b>	10% to 80%
<b>Altitude</b>	2,000 m max.
<b>Weight</b>	Approx. 100 g

**Note:** A driver must be installed in the personal computer. Refer to installation information in the operation manual for the Conversion Cable.

## ■ Communications Specifications

<b>Transmission line connection method</b>	RS-485 multipoint RS-232C
<b>Communications</b>	RS-485 (two-wire, half duplex), RS-232C
<b>Synchronization method</b>	Start-stop synchronization
<b>Baud rate</b>	1200, 2400, 4800, 9600, 19200, or 38400 bps
<b>Transmission code</b>	ASCII
<b>Data bit length (See note.)</b>	7 or 8 bits
<b>Stop bit length (See note.)</b>	1 or 2 bits
<b>Error detection</b>	Vertical parity (none, even, odd) Frame check sequence (FCS) with SYSWAY Block check character (BCC) with CompoWay/F or CRC-16 Modbus
<b>Flow control</b>	None
<b>Interface</b>	RS-485, RS-232C
<b>Retry function</b>	None
<b>Communications buffer</b>	40 bytes
<b>Communications response wait time</b>	0 to 99 ms Default: 20 ms

**Note:** The baud rate, data bit length, stop bit length, and vertical parity can be individually set using the Communications Setting Level.

## ■ Current Transformer (Sold Separately)

### Ratings

<b>Dielectric strength</b>	1,000 VAC for 1 min
<b>Vibration resistance</b>	50 Hz, 98 m/s <sup>2</sup>
<b>Weight</b>	E54-CT1: Approx. 11.5 g, E54-CT3: Approx. 50 g
<b>Accessories (E54-CT3 only)</b>	Armatures (2) Plugs (2)

## Heater Burnout Alarms and SSR Failure Detection Alarms

<b>Maximum heater current</b>	50 A AC
<b>Input current indication accuracy</b>	±5% FS ±1 digit max.
<b>Heater burnout alarm setting range</b>	0.1 to 49.9 A (in units of 0.1 A) 0.0 A: Heater burnout/SSR failure alarm output turned OFF. 50.0 A: Heater burnout/SSR failure alarm output turned ON. Minimum detection ON time: 190 ms (See note 1.)
<b>SSR failure detection alarm setting range</b>	0.1 to 49.9 A (in units of 0.1 A) 0.0 A: Heater burnout/SSR failure alarm output turned ON. 50.0 A: Heater burnout/SSR failure alarm output turned OFF. Minimum detection OFF time: 190 ms (See note 2.)

- Note:**
1. If the ON time of control output 1 is less than 190 ms, heater burnout detection and the heater current will not be measured.
  2. If the OFF time of control output 1 is less than 190 ms, SSR failure detection and the heater current will not be measured.

## Electrical Life Expectancy Curve for Relays (Reference Values)

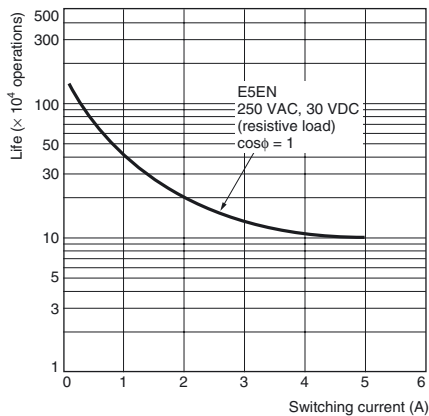

**Note:** Do not connect a DC load to a Controller with a Long-life Relay Output.

## E54-CT1 Thru-current ( $I_o$ ) vs. Output Voltage ( $E_o$ ) (Reference Values)

Maximum continuous heater current: 50 A (50/60 Hz)  
Number of windings:  $400 \pm 2$   
Winding resistance:  $18 \pm 2 \Omega$

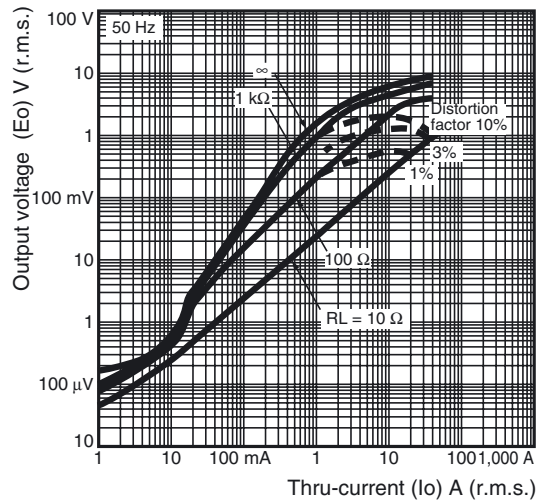

## E54-CT3 Thru-current ( $I_o$ ) vs. Output Voltage ( $E_o$ ) (Reference Values)

Maximum continuous heater current: 120 A (50/60 Hz)  
(Maximum continuous heater current for an OMRON Temperature Controller is 50 A.)  
Number of windings:  $400 \pm 2$   
Winding resistance:  $8 \pm 0.8 \Omega$

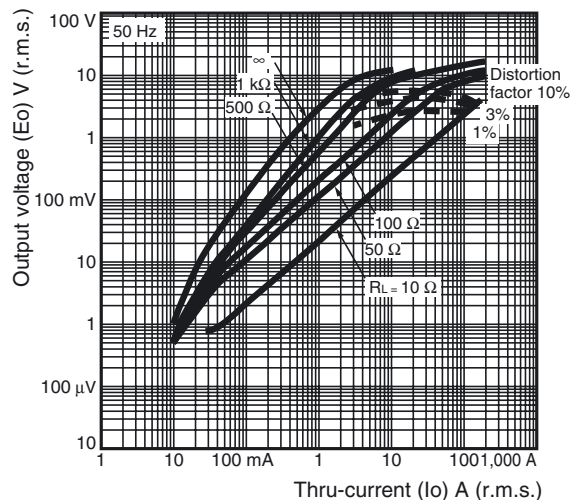

# External Connections

- The voltage output for control output 1 is not electrically insulated from the internal circuits. When using a grounding thermocouple, do not connect any of the control output terminals to ground. If the control output terminals are connected to ground, errors will occur in the measured temperature values as a result of leakage current. The voltage output for control output 2 is electrically insulated from the internal circuits with standard insulation.
- An R on the end of the lot number indicates that reinforced insulation is provided between the input power supply, relay outputs, and other terminals.
- Consult with your OMRON representative before using the external power supply for the ES1B for any other purpose.

## E5EN

Relay output  
250 VAC, 5 A  
(Resistive load)

100 to 240 VAC  
24 VAC/VDC (No polarity)

Voltage output  
12 VDC, 40 mA

Current output  
4 to 20 mA DC  
0 to 20 mA DC  
Load 600 Ω max.

Alarm output  
(Relay output),  
250 VAC, 3 A  
(Resistive load)

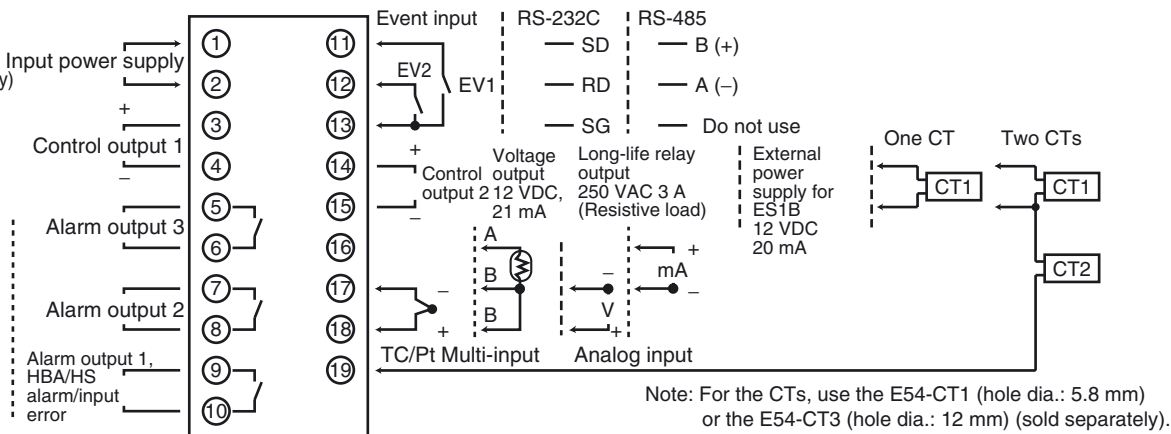

# Nomenclature

## E5EN

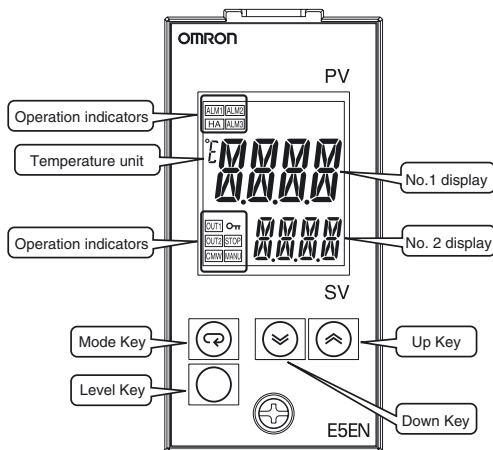



# Dimensions

## E5EN Terminal Models

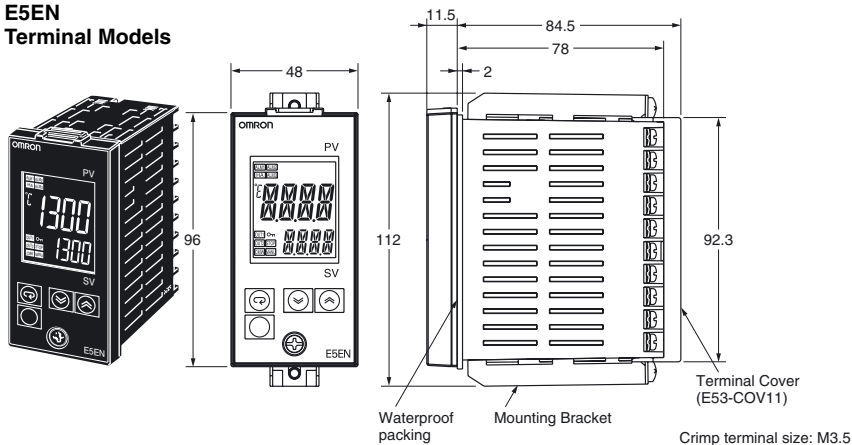

**Note:** To remove the Controller from the case, loosen the screw at the bottom of the front panel with a screwdriver while pressing down on the hook at the top of the front panel.

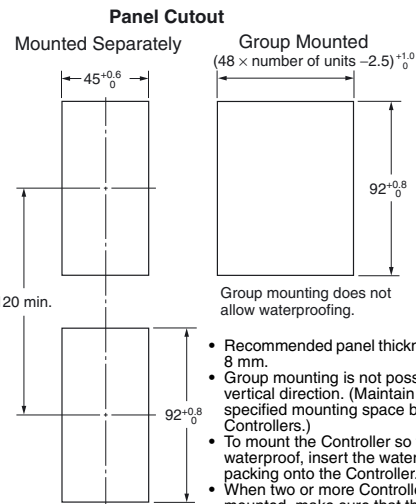

- Recommended panel thickness is 1 to 8 mm.
- Group mounting is not possible in the vertical direction. (Maintain the specified mounting space between Controllers.)
- To mount the Controller so that it is waterproof, insert the waterproof packing onto the Controller.
- When two or more Controllers are mounted, make sure that the surrounding temperature does not exceed the allowable operating temperature specified in the specifications.

## Accessories

### USB-Serial Conversion Cable (Sold Separately)

E58-CIFQ1

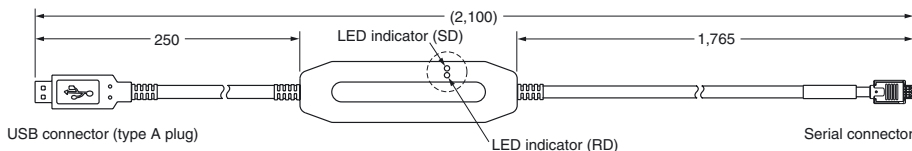

### Terminal Covers

E53-COV11  
(Two Covers provided.)

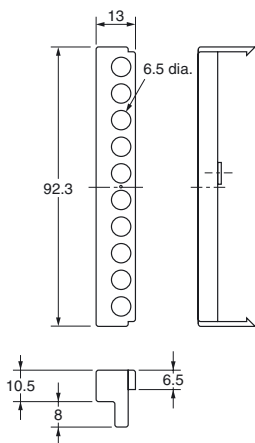
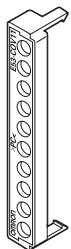

## Current Transformers (Sold Separately)

### E54-CT1

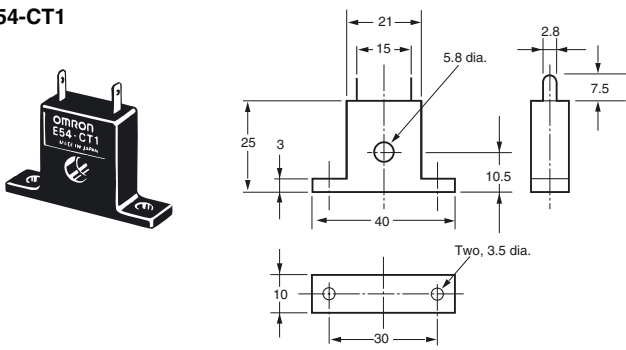

### E54-CT3

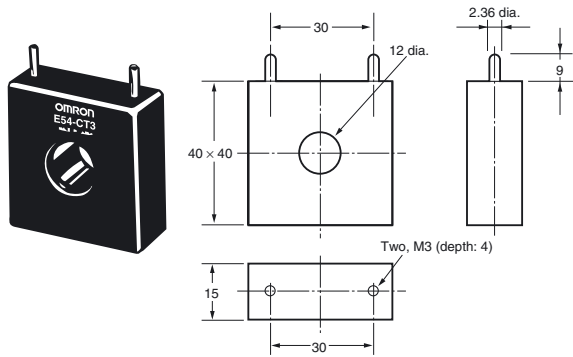

#### E54-CT3 Accessory

- Armature

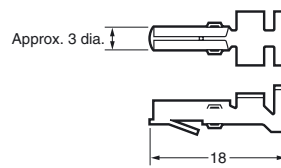

- Plug

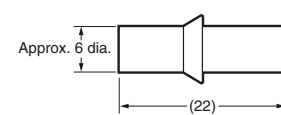

#### Connection Example

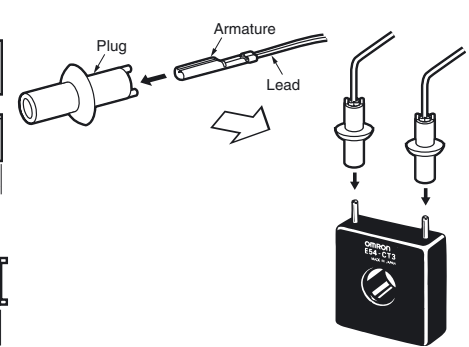

## Digital Temperature Controllers E5AN

**This Best-selling General-purpose Temperature Controller Is Now Even Better. USB-Serial Conversion Cable and Support Software Are Also Available.**

- Controllers now available with analog inputs.
- Faster sampling at 250 ms.
- Transfer output provided for easy output to recorders.
- Voltage outputs (to drive SSRs) for both heating and cooling control.
- Models available with three-phase heater burnout detection and SSR fault detection.
- Manual output provided.
- Controller available with long-life relay output.
- Easy setting with 11-segment displays.
- Connect to either a thermocouple or platinum resistance thermometer with the same model.
- Easily see the status from a distance with PV display with three-color switching function.

**Note:** Refer to Precautions on page 43.



**Note:** Refer to page 40 for information on changes in comparison to previous models.

## Features

### Improved Functions for a Wider Range of Application

#### Control Analog Values, such as Pressures, Flowrates, and Levels

The E5AN Series now also includes models that accept analog inputs, enabling control applications other than for temperature, including pressure, flowrate, level, humidity, and weight control.

#### Faster Sampling at 250 ms

The previous sampling time of 500 ms has been reduced by half to 250 ms. This enables the E5AN to handle application requiring even greater response speed and accuracy.

#### Easy Connector to a Recorder

A transfer output now makes it easy to connect to a recorder or PLC Analog I/O Unit.

#### Voltage Outputs (to Drive SSRs) for Both Heating and Cooling Control.

Voltage outputs can be used for both heating and cooling for Models with Two Control Outputs.

#### Three-phase Heater Burnout Detection

With Models with Three-phase Heater Burnout and SSR Failure Detection, two current transformers can be connected to detect both heater burnout and SSR failure at the same time, reducing costs because a separate heater burnout alarm device is not required. SSR failure detection can be used even with Models with Single-phase Heater Burnout Alarms.

### E58-CIFQ1 USB-Serial Conversion Cable for Computer Connection

**A personal computer connection is possible for models without communications.**

The CX-Thermo Support Software (sold separately) can be used to set parameters, monitor operation, and parameter masks. (CX-Thermo support of the E5AN is scheduled for March 2005.)

**Specifications:** page 29, **Dimensions:** page 35



# Model Number Structure

## Model Number Legend

E5AN-□□□M□-500  
 1 2 3 4 5

### 1. Output 1 type

- R: Relay
- Q: Voltage for driving SSR
- C: Current

### 2. Number of alarms

3: 3 alarms

### 3. Fixed option

- H: Heater burnout/SSR failure detection (1 CT)
- HH: Heater burnout/SSR failure detection (2 CT)
- Q: Voltage for driving SSR
- Y: Long-life Relay
- Blank: Not available

### 4. Option Unit

### 5. Input type

- T: Thermocouple/platinum resistance thermometer (multi-input)
- L: Analog input

## Ordering Information

### Temperature Input (Multi Input) Standard Models

Size	Power supply voltage	Number of alarm points	Control output	Heater alarm	Model
1/4 DIN 96 × 96 × 78 (W × H × D)	100 to 240 VAC	3	Relay	No	E5AN-R3MT-500
				Yes (1 CT)	E5AN-R3HMT-500
				Yes (2 CT)	E5AN-R3HHMT-500
			Voltage (for driving SSR)	No	E5AN-Q3MT-500
				Yes (1 CT)	E5AN-Q3HMT-500
				Yes (2 CT)	E5AN-Q3HHMT-500
	24 VAC/VDC	3	Current	No	E5AN-C3MT-500
			Relay	No	E5AN-R3MT-500
				Yes (1 CT)	E5AN-R3HMT-500
Voltage (for driving SSR)	No	E5AN-Q3MT-500			
	Yes (1 CT)	E5AN-Q3HMT-500			
Current	No	E5AN-C3MT-500			

### Temperature Input (Multi Input) 2 Outputs Models

Size	Power supply voltage	Number of alarm points	Control output 1	Control output 2	Model
1/4 DIN 96 × 96 × 78 (W × H × D)	100 to 240 VAC	3	Relay	Voltage (for driving SSR)	E5AN-R3QMT-500
			Voltage (for driving SSR)	Voltage (for driving SSR)	E5AN-Q3QMT-500
				Long-life Relay	E5AN-Q3YMT-500
			Current	Voltage (for driving SSR)	E5AN-C3QMT-500
				Long-life Relay	E5AN-C3YMT-500

### Analog Input Models

Size	Power supply voltage	Number of alarm points	Control output	heater alarm	Model
1/4 DIN 96 × 96 × 78 (W × H × D)	100 to 240 VAC	3	Relay	Yes (1 CT)	E5AN-R3HML-500
			Voltage (for driving SSR)	Yes (1 CT)	E5AN-Q3HML-500

### Option Units

Name	Function	Model
Communication Unit	RS-232C Communication	E53-EN01
	RS-485 Communication	E53-EN03
Event Input Unit	Event Input	E53-AKB

# Specifications











## ■ Ratings

Item		Power supply voltage	100 to 240 VAC, 50/60 Hz	24 VAC, 50/60 Hz or 24 VDC
<b>Operating voltage range</b>		85% to 110% of rated supply voltage		
<b>Power consumption</b>		Approx. 11 VA		Approx. 5.5 VA (24 VAC)/approx. 4 W (24 VDC)
<b>Sensor input</b>		Models with temperature inputs Thermocouple: K, J, T, E, L, U, N, R, S, or B Platinum resistance thermometer: Pt100 or JPt100 Infrared temperature sensor: 10 to 70°C, 60 to 120°C, 115 to 165°C, or 160 to 260°C Voltage input: 0 to 50 mV Models with analog inputs Current input: 4 to 20 mA or 0 to 20 mA Voltage input: 1 to 5 V, 0 to 5 V, or 0 to 10 V		
<b>Input impedance</b>		Current input: 150 Ω, Voltage input: 1 MΩ (Use a 1:1 connection when connecting the ES2-HB.)		
<b>Control output</b>	<b>Relay output</b>	SPST-NO, 250 VAC, 5 A (resistive load), electrical life: 100,000 operations, minimum applicable load: 5 V, 10 mA		
	<b>Voltage output</b>	Output voltage: 12 VDC +15/-20% (PNP), max. load current: 40 mA, with short-circuit protection circuit (max. load current for control output 2: 21 mA)		
	<b>Current output</b>	4 to 20 mA DC/0 to 20 mA DC, load: 600 Ω max., resolution: approx. 2,700		
	<b>Long-life relay output</b>	SPST-NO, 250 VAC, 3 A (resistive load), electrical life: 1,000,000 operations, load power supply voltage: 75 to 250 VAC (DC loads cannot be connected.), minimum applicable load: 5 V, 10 mA, leakage current: 5 mA max. (250 VAC, 60 Hz)		
<b>Alarm output</b>		SPST-NO, 250 VAC, 3 A (resistive load), electrical life: 100,000 operations, minimum applicable load: 1 V, 1 mA		
<b>Event input</b>	<b>Contact input</b>	ON: 1 kΩ max., OFF: 100 kΩ min.		
	<b>Non-contact input</b>	ON: Residual voltage: 1.5 V max., OFF: Leakage current: 0.1 mA max.		
		Outflow current: Approx. 7 mA per point		
<b>Control method</b>		ON/OFF control or 2-PID control (with auto-tuning)		
<b>Setting method</b>		Digital setting using front panel keys		
<b>Indication method</b>		11-segment digital display and individual indicators (7-segments displays also possible) Character height: PV: 15 mm, SV: 9.5 mm		
<b>Other functions</b>		Manual output, heating/cooling control, transfer output (on some models), loop break alarm, multi SP, MV limiter, input digital filter, self-tuning, temperature input shift, run/stop, protection functions, etc.		
<b>Ambient operating temperature</b>		-10 to 55°C (with no icing or condensation), for 3-year warranty: -10 to 50°C		
<b>Ambient operating humidity</b>		25% to 85%		
<b>Storage temperature</b>		-25 to 65°C (with no icing or condensation)		

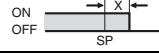
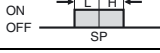

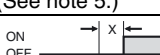
## Alarm Types

Select alarm types out of the 12 alarm types listed in the following table.

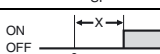
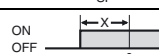
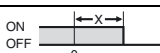
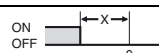
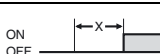
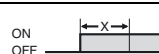
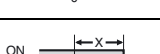
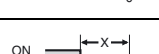
Set value	Alarm type	Alarm output operation	
		When X is positive	When X is negative
0	Alarm function OFF	Output OFF	
1 (See note 1.)	Upper- and lower-limit		(See note 2.)
2	Upper limit		
3	Lower limit		
4 (See note 1.)	Upper- and lower-limit range		(See note 3.)
5 (See note 1.)	Upper- and lower-limit with standby sequence		(See note 4.)
6	Upper-limit with standby sequence		
7	Lower-limit with standby sequence		
8	Absolute-value upper-limit		
9	Absolute-value lower-limit		
10	Absolute-value upper-limit with standby sequence		
11	Absolute-value lower-limit with standby sequence		
12 (See note 6.)	LBA (for alarm 1 only)	---	

**Note: 1.** With set values 1, 4 and 5, the upper and lower limit values can be set independently for each alarm type, and are expressed as “L” and “H.”

**2.** Set value: 1, Upper- and lower-limit alarm

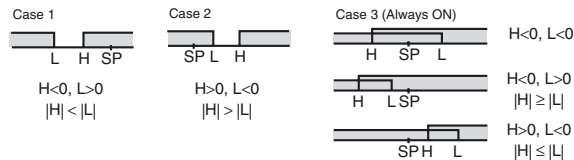

**3.** Set value: 4, Upper- and lower-limit range

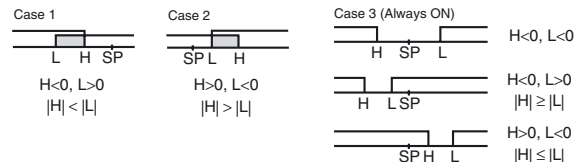

**4.** Set value: 5, Upper- and lower-limit with standby sequence  
For Upper- and Lower-Limit Alarm Described Above

- Case 1 and 2  
Always OFF when the upper-limit and lower-limit hysteresis overlaps.
- Case 3: Always OFF

**5.** Set value: 5, Upper- and lower-limit with standby sequence  
Always OFF when the upper-limit and lower-limit hysteresis overlaps.

**6.** Set value: 12, LBA can be set only for alarm 1.

Set the alarm types for alarms 1 to 3 independently in the initial setting level. The default setting is 2 (upper limit).

## ■ Characteristics

<b>Indication accuracy</b>	Thermocouple: (See note 1.) (±0.5% of indicated value or ±1°C, whichever is greater) ±1 digit max. Platinum resistance thermometer: (±0.5% of indicated value or ±1°C, whichever is greater) ±1 digit max. Analog input: ±0.5% FS ±1 digit max. CT input: ±5% FS ±1 digit max.
<b>Influence of temperature (See note 2.)</b>	R, S, and B thermocouple inputs: (±1% of PV or ±10°C, whichever is greater) ±1 digit max. Other thermocouple inputs: (±1% of PV or ±4°C, whichever is greater) ±1 digit max. ±10°C for -100°C or less for K sensors Platinum resistance thermometer inputs: (±1% of PV or ±2°C, whichever is greater) ±1 digit max. Analog inputs: (±1% of FS) ±1 digit max.
<b>Influence of voltage (See note 2.)</b>	
<b>Hysteresis</b>	Models with thermocouple/platinum resistance thermometer (multi-input) input: 0.1 to 999.9 EU (in units of 0.1 EU) (See note 3.) Models with analog input: 0.01 to 99.99% FS (in units of 0.01% FS)
<b>Proportional band (P)</b>	Models with thermocouple/platinum resistance thermometer (multi-input) input: 0.1 to 999.9 EU (in units of 0.1 EU) (See note 3.) Models with analog input: 0.1 to 999.9% FS (in units of 0.1% FS)
<b>Integral time (I)</b>	0 to 3999 s (in units of 1 s)
<b>Derivative time (D)</b>	0 to 3999 s (in units of 1 s) (See note 4.)
<b>Control period</b>	0.5, 1 to 99 s (in units of 1 s)
<b>Manual reset value</b>	0.0 to 100.0% (in units of 0.1%)
<b>Alarm setting range</b>	-1999 to 9999 (decimal point position depends on input type)
<b>Sampling period</b>	250 ms
<b>Affect of signal source resistance</b>	Thermocouple: 0.1°C/Ω max. (100 Ω max.) (See note 5.) Platinum resistance thermometer: 0.4°C/Ω max. (10 Ω max.)
<b>Insulation resistance</b>	20 MΩ min. (at 500 VDC)
<b>Dielectric strength</b>	2,000 VAC, 50 or 60 Hz for 1 min (between terminals with different charge)
<b>Vibration resistance</b>	<b>Malfunction</b>
	<b>Destruction</b>
<b>Shock resistance</b>	<b>Malfunction</b>
	<b>Destruction</b>
<b>Weight</b>	Controller: Approx. 310 g, Mounting Bracket: Approx. 100 g
<b>Degree of protection</b>	Front panel: NEMA4X for indoor use (equivalent to IP66) Rear case: IP20, Terminal section: IP00
<b>Memory protection</b>	Non-volatile memory (number of writes: 1,000,000 operations)
<b>EMC</b>	Emission AClosure: EN55011 Group1 Class A Emission AC Mains: EN55011 Group1 Class A Immunity ESD: EN61000-4-2 4 kV contact discharge (level 2) 8 kV air discharge (level 3) Immunity RF-interference: EN61000-4-3 10 V/m (80-1000 MHz, 1.4-2.0 GHz amplitude modulated) (level 3) 10 V/m (900 MHz pulse modulated) Immunity Conducted Disturbance: EN61000-4-6 3 V (0.15 to 80 MHz) (level 2) EN61000-4-4 2 kV Power-line (level 3) 1 kV I/O signal-line (level 3) Immunity Burst: EN61000-4-4 2 kV Power-line (level 3) 1 kV I/O signal-line (level 3) Immunity Surge: EN61000-4-5 1kV line to line Power line, output line (relay output) 2 kV line to ground Power line, output line (relay output) 1 kV line to ground Input line (communication) Immunity Voltage Dip/Interrupting: EN61000-4-11 0.5 cycle, 100% (rated voltage)
<b>Approved standards</b>	UL 61010C-1 CSA C22.2 No.1010.1
<b>Conformed standards</b>	EN61326, EN61010-1, IEC61010-1 VDE0106 Part 100 (Finger protection), when the terminal cover is mounted.

**Note: 1.** The indication accuracy of K thermocouples in the -200 to 1300°C range, T and N thermocouples at a temperature of -100°C max., and U and L thermocouples at any temperature is ±2°C ±1 digit maximum. The indication accuracy of the B thermocouple at a temperature of 400°C max. is not specified. The indication accuracy of the R and S thermocouples at a temperature of 200°C max. is ±3°C ±1 digit max.

2. Conditions: Ambient temperature: -10°C to 23°C to 55°C, Voltage range: -15% to +10% of rated voltage
3. "EU" stands for Engineering Unit and is used as the unit after scaling. For a temperature sensor, the EU is °C or °F.
4. When robust tuning (RT) is ON, the differential time is 0.0 to 999.9 (in units of 0.1 s).
5. B, R, and S sensors: 0.2°C/Ω max. (100 Ω max.)

## ■ USB-Serial Conversion Cable

<b>Applicable OS</b>	Windows 2000/XP
<b>Applicable software</b>	Thermo Mini, CX-Thermo
<b>Applicable models</b>	E5CN/E5CN-U/E5AN/E5EN
<b>USB interface standard</b>	Conforms to USB Specification 1.1.
<b>DTE speed</b>	38400 bps
<b>Connector specifications</b>	Computer: USB (type A plug) Temperature Controller: Serial
<b>Power supply</b>	Bus power (Supplied from USB host controller.)
<b>Power supply voltage</b>	5 VDC
<b>Current consumption</b>	70 mA
<b>Ambient operating temperature</b>	0 to 55°C (with no condensation or icing)
<b>Ambient operating humidity</b>	10% to 80%
<b>Storage temperature</b>	-20 to 60°C (with no condensation or icing)
<b>Storage humidity</b>	10% to 80%
<b>Altitude</b>	2,000 m max.
<b>Weight</b>	Approx. 100 g

**Note:** A driver must be installed in the personal computer. Refer to installation information in the operation manual for the Conversion Cable.

## ■ Communications Specifications

<b>Transmission line connection method</b>	RS-485 multipoint RS-232C
<b>Communications</b>	RS-485 (two-wire, half duplex), RS-232C
<b>Synchronization method</b>	Start-stop synchronization
<b>Baud rate</b>	1200, 2400, 4800, 9600, 19200, or 38400 bps
<b>Transmission code</b>	ASCII
<b>Data bit length</b>	7 or 8 bits
<b>Stop bit length</b>	1 or 2 bits
<b>Error detection</b>	Vertical parity (none, even, odd) Frame check sequence (FCS) with SYSWAY Block check character (BCC) with CompoWay/F or CRC-16 Modbus
<b>Flow control</b>	None
<b>Interface</b>	RS-485, RS-232C
<b>Retry function</b>	None
<b>Communications buffer</b>	40 bytes
<b>Communications response wait time</b>	0 to 99 ms Default: 20 ms

**Note:** The baud rate, data bit length, stop bit length, and vertical parity can be individually set using the Communications Setting Level.

## ■ Current Transformer (Sold Separately) Ratings

<b>Dielectric strength</b>	1,000 VAC for 1 min
<b>Vibration resistance</b>	50 Hz, 98 m/s <sup>2</sup>
<b>Weight</b>	E54-CT1: Approx. 11.5 g, E54-CT3: Approx. 50 g
<b>Accessories (E54-CT3 only)</b>	Armatures (2) Plugs (2)



## Heater Burnout Alarms and SSR Failure Detection Alarms

<b>Maximum heater current</b>	50 A AC
<b>Input current indication accuracy</b>	±5% FS ±1 digit max.
<b>Heater burnout alarm setting range</b>	0.1 to 49.9 A (in units of 0.1 A) 0.0 A: Heater burnout/SSR failure alarm output turned OFF. 50.0 A: Heater burnout/SSR failure alarm output turned ON. Minimum detection ON time: 190 ms (See note 1.)
<b>SSR failure detection alarm setting range</b>	0.1 to 49.9 A (in units of 0.1 A) 0.0 A: Heater burnout/SSR failure alarm output turned ON. 50.0 A: Heater burnout/SSR failure alarm output turned OFF. Minimum detection OFF time: 190 ms (See note 2.)

- Note:**
- If the ON time of control output 1 is less than 190 ms, heater burnout detection and the heater current will not be measured.
  - If the OFF time of control output 1 is less than 190 ms, SSR failure detection and the heater current will not be measured.

## Electrical Life Expectancy Curve for Relays (Reference Values)

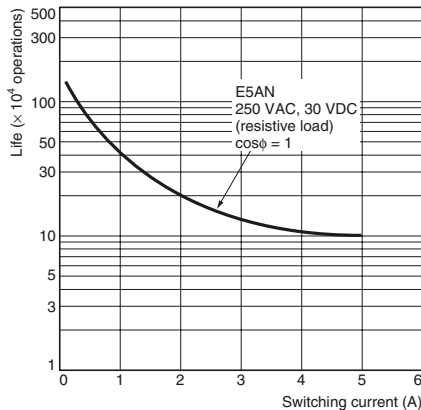

**Note:** Do not connect a DC load to a Controller with a Long-life Relay Output.

## E54-CT1 Thru-current (Io) vs. Output Voltage (Eo) (Reference Values)

Maximum continuous heater current: 50 A (50/60 Hz)  
Number of windings: 400±2  
Winding resistance: 18±2 Ω

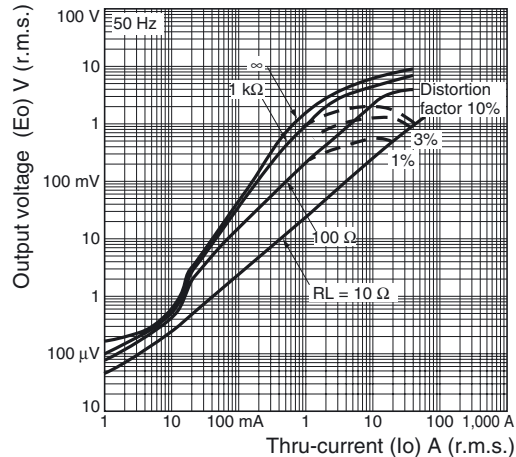

## E54-CT3 Thru-current (Io) vs. Output Voltage (Eo) (Reference Values)

Maximum continuous heater current: 120 A (50/60 Hz)  
(Maximum continuous heater current for an OMRON Temperature Controller is 50 A.)  
Number of windings: 400±2  
Winding resistance: 8±0.8 Ω

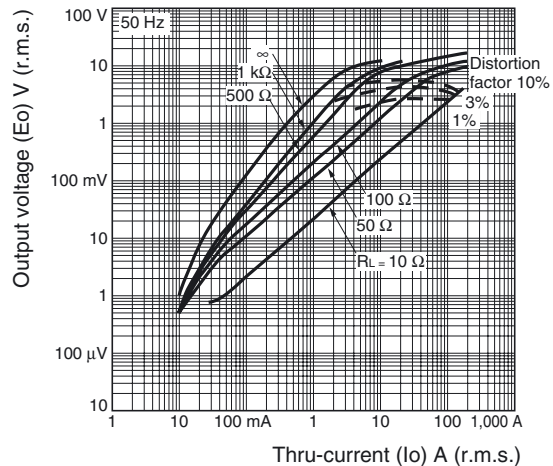

# External Connections

- The voltage output for control output 1 is not electrically insulated from the internal circuits. When using a grounding thermocouple, do not connect any of the control output terminals to ground. If the control output terminals are connected to ground, errors will occur in the measured temperature values as a result of leakage current. The voltage output for control output 2 is electrically insulated from the internal circuits with standard insulation.
- An R on the end of the lot number indicates that reinforced insulation is provided between the input power supply, relay outputs, and other terminals.

## E5AN

Relay output  
250 VAC, 5 A  
(Resistive load)

100 to 240 VAC  
24 VAC/VDC (no polarity)

Voltage output  
12 VDC, 40 mA

Current output  
4 to 20 mA DC  
0 to 20 mA DC  
Load 600 Ω max.

Alarm output  
(Relay output),  
250 VAC, 3 A  
(Resistive load)

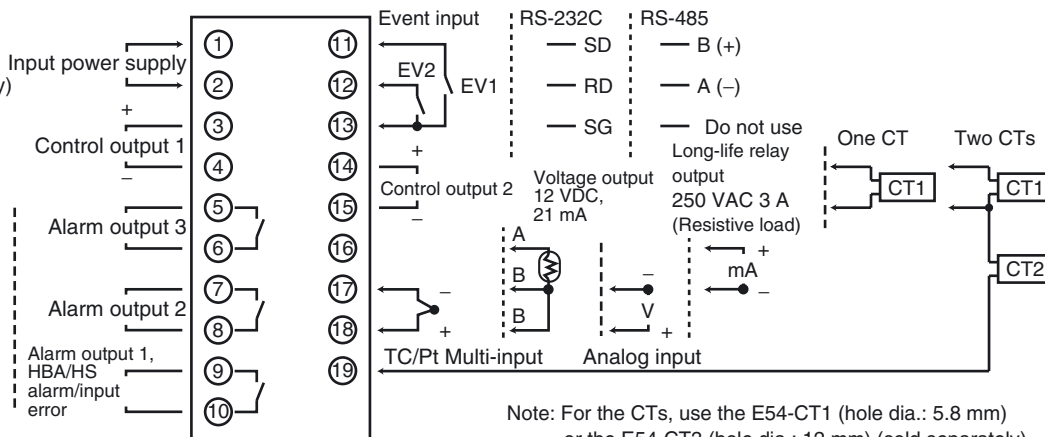

Note: For the CTs, use the E54-CT1 (hole dia.: 5.8 mm) or the E54-CT3 (hole dia.: 12 mm) (sold separately).

# Nomenclature

## E5AN

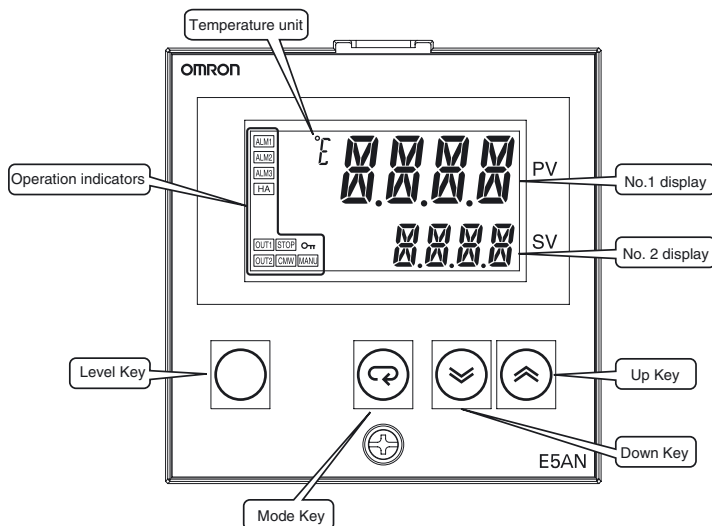

# Dimensions

## E5AN

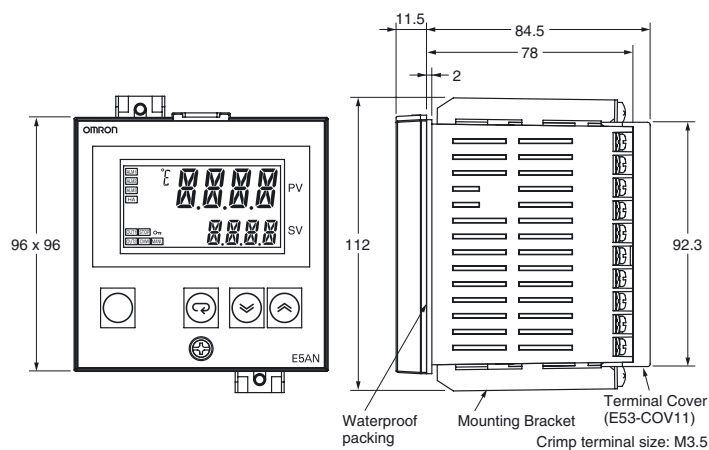

**Note:** To remove the Controller from the case, loosen the screw at the bottom of the front panel with a screwdriver while pressing down on the hook at the top of the front panel.

### Panel Cutout

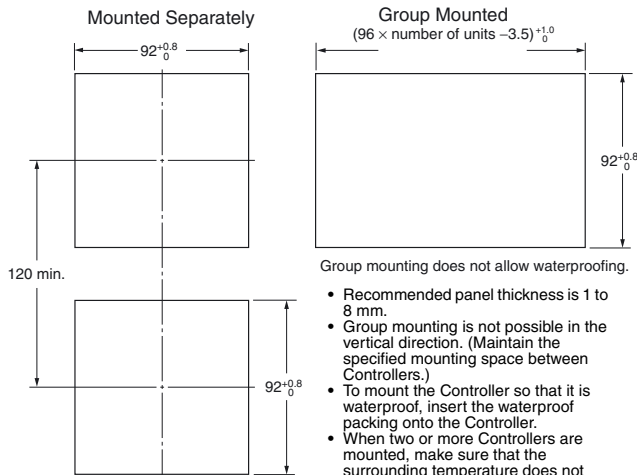

Group mounting does not allow waterproofing.

- Recommended panel thickness is 1 to 8 mm.
- Group mounting is not possible in the vertical direction. (Maintain the specified mounting space between Controllers.)
- To mount the Controller so that it is waterproof, insert the waterproof packing onto the Controller.
- When two or more Controllers are mounted, make sure that the surrounding temperature does not exceed the allowable operating temperature specified in the specifications.

## ■ Accessories

### USB-Serial Conversion Cable (Sold Separately)

E58-CIFQ1

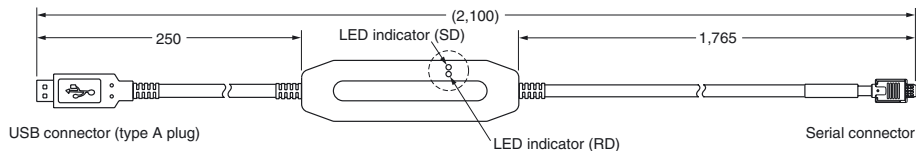

### Terminal Cover (Sold Separately)

E53-COV11  
(Two Covers provided.)

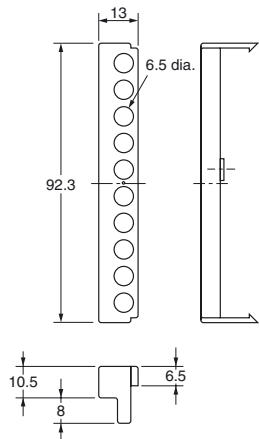
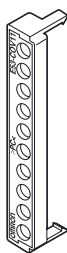

### Current Transformers (Sold Separately)

E54-CT1

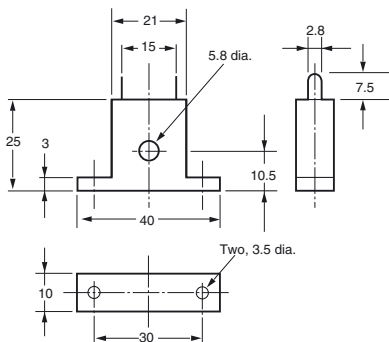
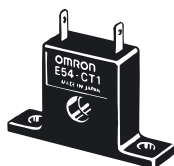

E54-CT3

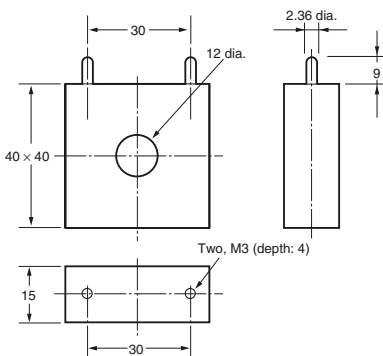
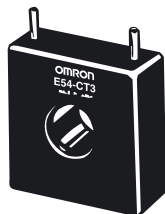

#### E54-CT3 Accessory

##### • Armature

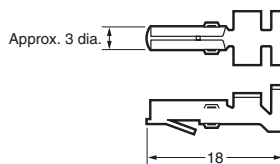

##### • Plug

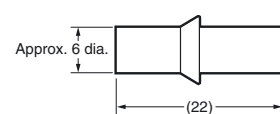

#### Connection Example

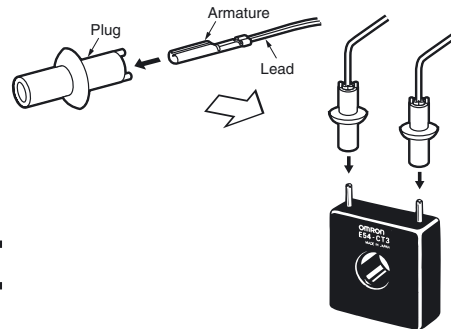

# Operation

## Outline of Operation Procedures

The following diagram illustrates the entire setting level. A password is required to enter the advance function setting level and the calibration level. Some parameters may not be displayed depending on the protection settings and operation conditions. The control operation will stop when switching from operation level to initial setting level.

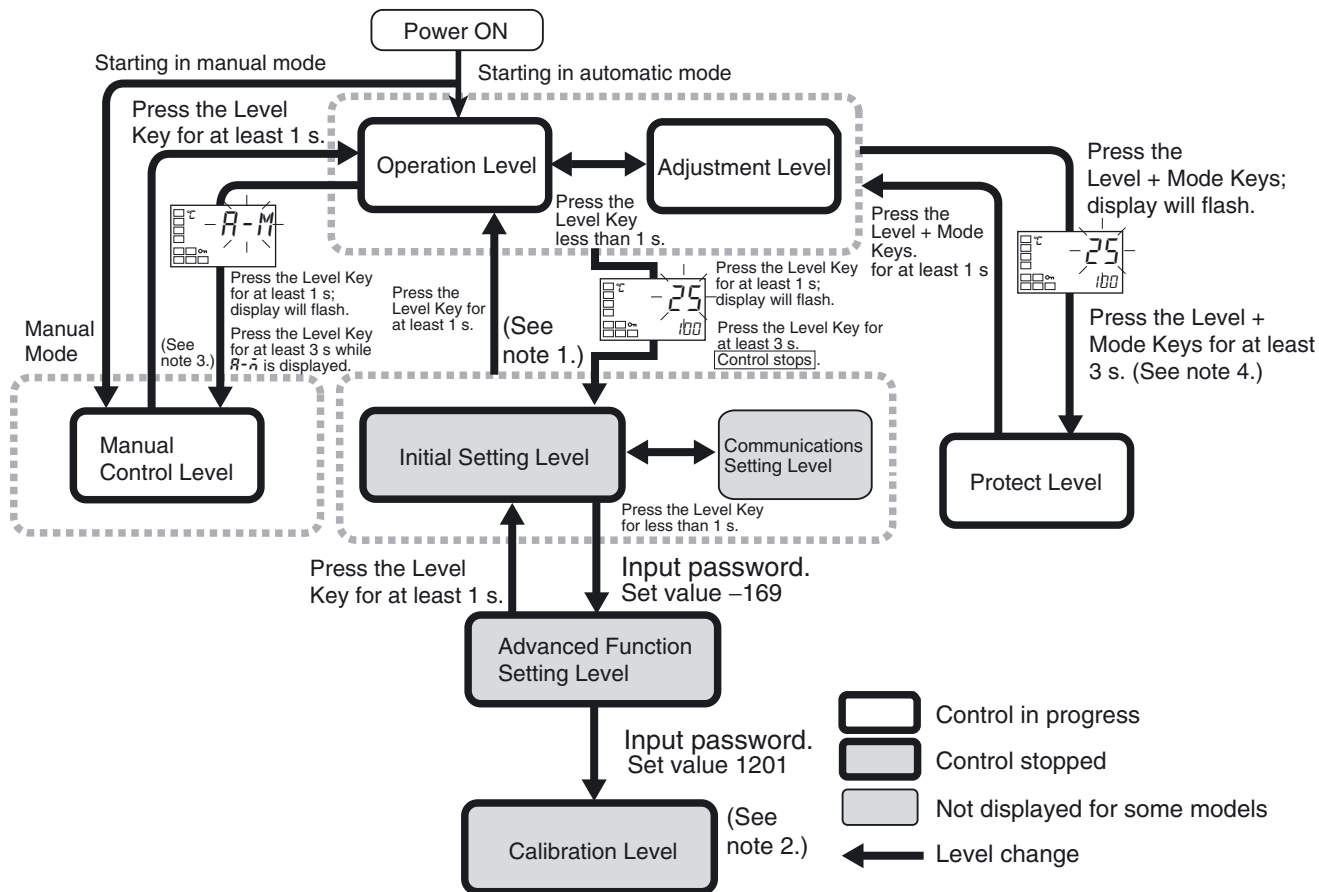

- Note:**
1. Operation level entered for software reset.
  2. You cannot move to other levels by operating the keys on the front panel from the calibration level. You must turn OFF the power supply.
  3. You can move only to the operation level by operating the keys on the front panel from the manual control level.
  4. The time taken to move to the protect level can be adjusted by changing the “Move to protect level time” setting.

## Troubleshooting

If an error occurs, an error message will be displayed on the No. 1 display. Use the error message to check the type of error and correct the error accordingly.

No. 1 display	Error	Correction	Output status at error	
			Control outputs	Alarm outputs
S.ERR (S. Err)	Input error (See note 2.)	Check for input wiring errors, broken wires, short-circuits, and input type error.	OFF	Handled as abnormally high temperature
	A/D converter error (See note 2.)	Check for an input error and then cycle the power supply. If the same error is still displayed, repairs will be necessary. If the Temperature Controller is normal after cycling the power supply, the error may have been caused by noise. Check for noise being generated nearby.	OFF	OFF
E111 (E111)	Memory error	Cycle the power supply. If the same error is still displayed, repairs will be necessary. If the Temperature Controller is normal after cycling the power supply, the error may have been caused by noise. Check for noise being generated nearby.	OFF	OFF
H.ERR (H. Err)	Internal circuit error (See note 2.)		OFF	OFF

- Note:**
1. If the input exceeds its within the controllable range but exceeds the display range (–1999 to 9999),  $\overline{\text{CCCC}}$  will be displayed if the temperature is less than –1999 and  $\overline{\text{9999}}$  will be displayed if the temperature is more than 9999. The control and alarm outputs will function normally during these displays. Refer to the E5CN/E5CN-U/E5AN/E5EN Temperature Controller User’s Manual (Cat. No. H134) for information on the controllable range.
  2. These errors are displayed only when the PV/SP is displayed. Errors are not displayed in other display modes.

# Parameters

Some parameters are not displayed depending on the model of the Controller and parameter settings. For details, refer to the E5CN/E5AN/E5EN/ Temperature Controller User's Manual (Cat. No. H134).

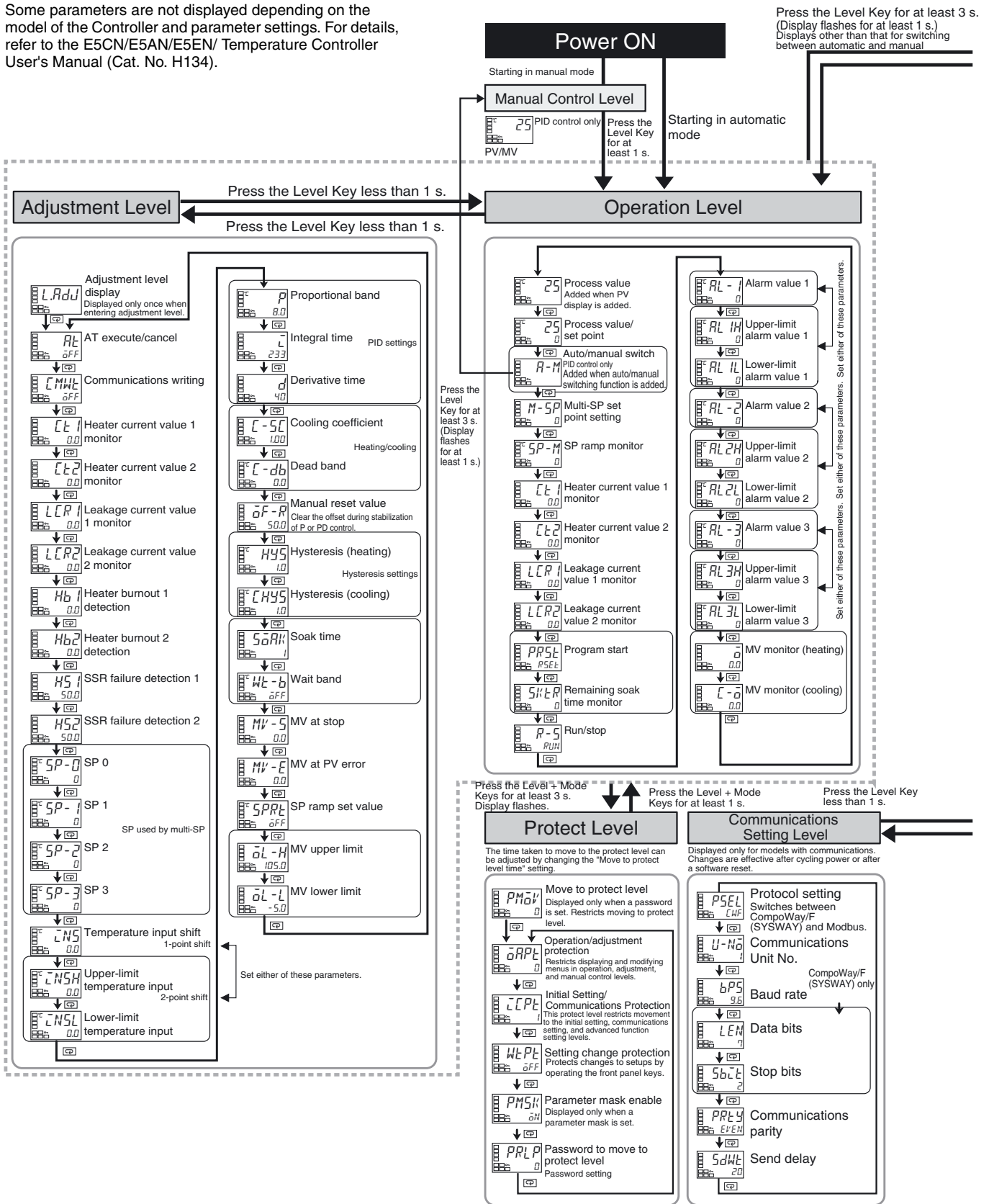

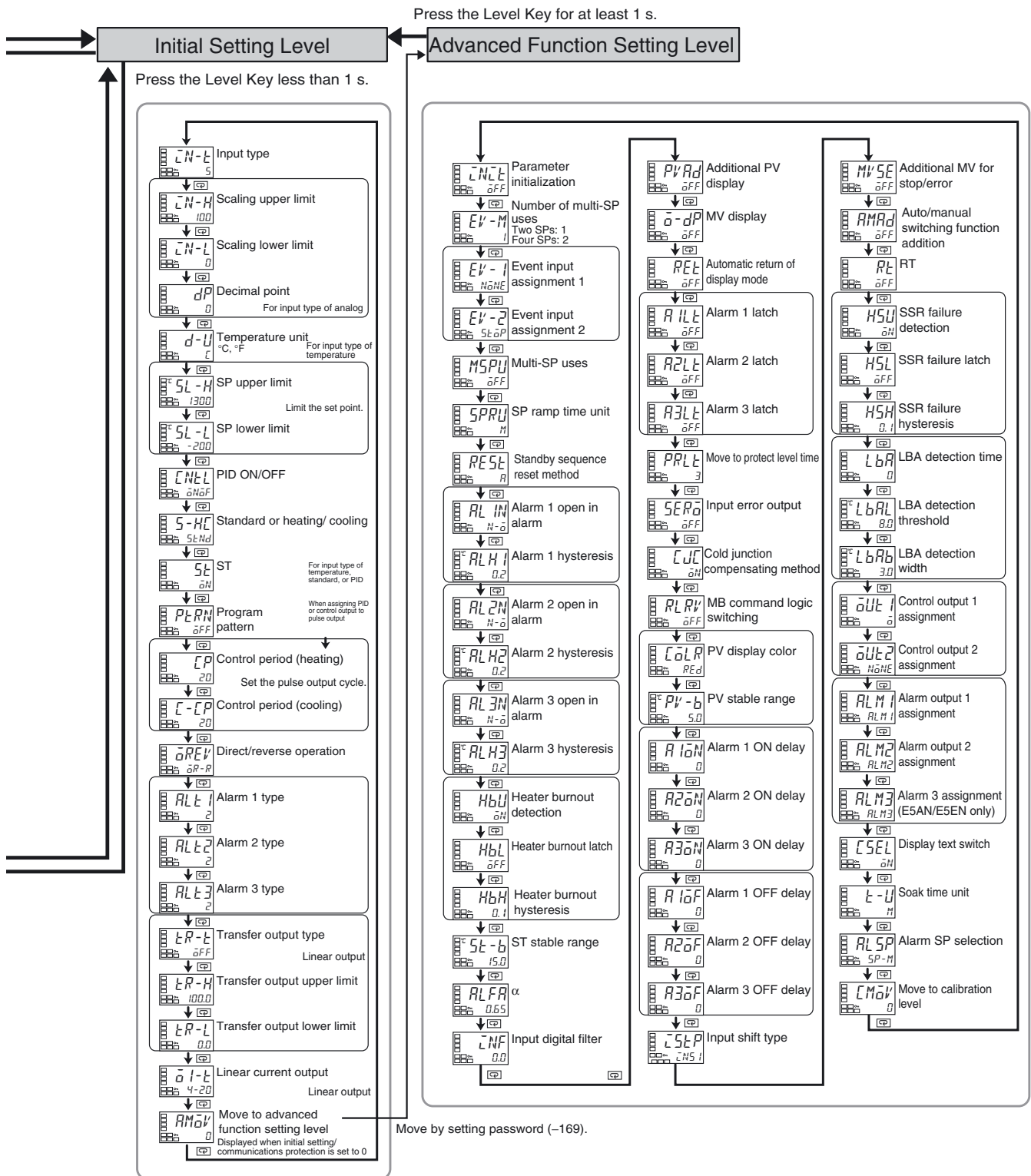

# Improvements to E5□N Functionality

## ■ Changes

Model numbers have been changed to allow for multi-input specifications.

### Before Change

E5□N-□□□TC (models for thermocouples)  
E5□N-□□□P (models for platinum resistance thermometers)



### After Change

E5□N-□□□T  
(Models that support both thermocouples and platinum resistance thermometers)

## Precautions in Replacing Previous Controllers

- The input type setting numbers have changed to allow for multi-input specifications. (The default setting is for a K sensor between -200 and 1,300°C.)
- Previous E5□N Controllers cannot be removed from the case for replacement with new models. Replace the case at the same time.
- The previous ThermoTools cannot be used with the new Controller models. Use CX-Thermo Support Software.
- The height of the front panel that extends when the Controller is mounted to a panel has been reduced from 9 to 6 mm for only the E5CN.

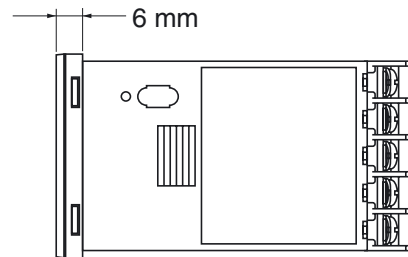

The following items have not changed in comparison to the previous E5□N models: Panel cutout, Internal panel dimensions for panel mounting, wiring screw sizes, wiring terminal arrangement, and parameter setting methods.

## ■ Improved Functions

The previous and new models can be easily differentiated by looking at the front panel. The OMRON logo is in a different position.

Item	Previous models (OMRON logo: lower left)	Improved models (OMRON logo: upper left)
Front panel (E5CN)		

Basically, the Controllers are upwardly compatible. The terminal arrangement, terminal sizes, and depth for panel mounting have not been changed. Changes are listed in the following tables. For details, refer to the E5CN/E5CN-U/E5AN/E5EN Temperature Controller User's Manual (Cat. No. H134).



## ■ Specifications (Main Changes)

### Ratings

Item		Previous models	Improved models
Sensor input		E5□N-□□TC Thermocouple: K, J, T, E, L, U, N, R, S, or B Infrared temperature sensor: 10 to 70°C, 60 to 120°C or 115 to 165°C (160 to 260°C) Voltage input: 0 to 50 mV	E5□N-□□T (Multi-input models) Thermocouple: K, J, T, E, L, U, N, R, S, or B Infrared temperature sensor: 10 to 70°C, 60 to 120°C or 115 to 165°C (160 to 260°C) Voltage input: 0 to 50 mV Platinum resistance thermometer: Pt100 or JPt100
		E5□N-□□P Platinum resistance thermometer: Pt100 or JPt100	
		(No models with analog inputs)	E5□N-□□L (Models with analog inputs added.) Current input: 4 to 20 mA or 0 to 20 mA Voltage input: 1 to 5 V, 0 to 5 V, or 0 to 10 V
Control output	Relay	E5CN SPST-NO, 250 VAC, 3 A (resistive load) Electrical life: 100,000 operations min. E5EN/E5AN SPST-NO, 250 VAC, 5 A (resistive load) Electrical life: 100,000 operations min.	E5CN SPST-NO, 250 VAC, 3 A (resistive load) Electrical life: 100,000 operations min. E5EN/E5AN SPST-NO, 250 VAC, 5 A (resistive load) Electrical life: 100,000 operations min.
	Long-life relay	---	E5□N-Y□□ (Added models with long-life relay outputs.) SPST-NO, 250 VAC, 3 A (resistive load) Electrical life: 1,000,000 operations min. DC loads cannot be connected.
	Voltage	E5CN 12 VDC ±15% (PNP) Max. load current: 21 mA With short-circuit protection E5EN/E5AN 12 VDC ±15%/–20% (PNP) Max. load current: 40 mA With short-circuit protection	E5CN 12 VDC ±15% (PNP) Max. load current: 21 mA With short-circuit protection E5EN/E5AN 12 VDC ±15%/–20% (PNP) Max. load current: 40 mA With short-circuit protection
	Current	E5□N-C□□ 4 to 20 mA DC Load: 600 Ω max. Resolution: Approx. 2,600	E5□N-C□□ 4 to 20 mA DC or 0 to 20 mA DC Load: 600 Ω max. Resolution: Approx. 2,700
Control output 2	Voltage	(No models with two control outputs)	E5CN-□Q□ 12 VDC ±15% (PNP) Max. load current: 21 mA With short-circuit protection E5EN/E5AN 12 VDC ±15%/–20% (PNP) Max. load current: 21 mA With short-circuit protection
Display method		7-segment digital display and single-LED indicators	11-segment digital display and single-LED indicator (Improved visibility) (A 7-segment digital display also possible.)
Transfer output		(No models with transfer outputs)	Allocated to current output 4 to 20 mA DC or 0 to 20 mA DC Load: 600 Ω max. Resolution: Approx. 2,700
External power supply for ES1B		---	E5CN/E5EN 12 VDC ±10%, 20 mA, With short-circuit protection

## Other Functions

Item	Previous models	Improved models
Display	---	Parameter mask function (provided with CX-Thermo Support Software)
	PV display switch between 2 colors (red/green)	PV display switch between 3 colors (red/amber/green)
	---	Display character switch (7-segment/11-segment)
Input	Temperature input shift (1-point shift for temperature input, 2-point shift for no-contact sensor input)	Temperature input shift (2-point shift also possible for temperature input)
Output	---	Manual outputs
	---	MV at stop
	---	MV at PV error
	---	Loop break alarm
Control	Control period: 1 to 99 s	Control period: 0.5 or 1 to 99 s
	---	Robust tuning
Alarm	---	Alarm delays
	---	Alarm SP selection (selection of alarm operation during SP ramp)
Other	---	Simple programming function
	---	Password to move to protect level
	---	Communications port for Support Software

## Characteristics

Item	Previous models	Improved models
Sampling period	500 ms	250 ms

## Communications Specifications

Item	Previous models	Improved models
Communications protocols	CompoWay/F (SYSWAY)	CompoWay/F (SYSWAY), Modbus
Baud rate	1200, 2400, 4800, 9600, 19200 bps	1200, 2400, 4800, 9600, 19200, 38400 bps

## Heater Burnout/SSR Failure Detection Characteristics

Item	Previous models	Improved models
Maximum heater current	Option Units Single-phase 50 A VAC	Option Units Single-phase 50 A AC
	---	Option Units (two CT inputs) Three-phase 50 A AC
SSR failure detection	---	SSR failure detection

# Precautions

## ⚠ CAUTION

Do not touch the terminals while power is being supplied. Doing so may occasionally result in minor injury due to electric shock.



Do not allow pieces of metal, wire clippings, or fine metallic shavings or filings from installation to enter the product. Doing so may occasionally result in electric shock, fire, or malfunction.



Do not use the product where subject to flammable or explosive gas. Otherwise, minor injury from explosion may occasionally occur.



Do not leave the conversion cable connected to the product. Malfunction may occur due to noise in the cable.



Do not use the Temperature Controller or Conversion Cable if it is damaged. Doing so may occasionally result in minor electric shock or fire.



Never disassemble, modify, or repair the product or touch any of the internal parts. Minor electric shock, fire, or malfunction may occasionally occur.



### CAUTION - Risk of Fire and Electric Shock

- a) This product is UL listed as Open Type Process Control Equipment. It must be mounted in an enclosure that does not allow fire to escape externally.
- b) More than one disconnect switch may be required to de-energize the equipment before servicing the product.
- c) Signal inputs are SELV, limited energy. (See note 1.)
- d) Caution: To reduce the risk of fire or electric shock, do not interconnect the outputs of different Class 2 circuits. (See note 2.)



If the output relays are used past their life expectancy, contact fusing or burning may occasionally occur. Always consider the application conditions and use the output relays within their rated load and electrical life expectancy. The life expectancy of output relays varies considerably with the output load and switching conditions.



Tighten the terminal screws to between 1.13 and 1.36 N·m. Loose screws may occasionally result in fire. (See note 3.)



Set the parameters of the product so that they are suitable for the system being controlled. If they are not suitable, unexpected operation may occasionally result in property damage or accidents.



A malfunction in the product may occasionally make control operations impossible or prevent alarm outputs, resulting in property damage. To maintain safety in the event of malfunction of the product, take appropriate safety measures, such as installing a monitoring device on a separate line.



A semiconductor is used in the output section of long-life relays. If excessive noise or surge is impressed on the output terminals, a short-circuit failure is likely to occur. If the output remains shorted, fire will occur due to overheating of the heater or other cause. Take measures in the overall system to prevent excessive temperature increase and to prevent fire from spreading.



Do not allow pieces of metal or wire cuttings to get inside connectors. Failure to do so may occasionally result in minor electric shock, fire, or damage to equipment.



Do not allow dust and dirt to collect between the pins in the connector on the Conversion Cable. Failure to do so may occasionally result in fire.



- Note:**
1. An SELV circuit is one separated from the power supply with double insulation or reinforced insulation, that does not exceed 30 V r.m.s. and 42.4 V peak or 60 VDC.
  2. A class 2 power supply is one tested and certified by UL as have the current and voltage of the secondary output restricted to specific levels.
  3. The tightening torque for E5CN-U is 0.5 N·m.

## Precautions for Safe Use

Be sure to observe the following precautions to prevent malfunction or adverse effects on the performance or functionality of the product. Not doing so may occasionally result in faulty operation.

- This product is specifically designed for indoor use only. Do not use this product in the following places:
  - Places directly subject to heat radiated from heating equipment.
  - Places subject to splashing liquid or oil atmosphere.
  - Places subject to direct sunlight.
  - Places subject to dust or corrosive gas (in particular, sulfide gas and ammonia gas).
  - Places subject to intense temperature change.
  - Places subject to icing and condensation.
  - Places subject to vibration and large shocks.
- Use and store the product within the rated ambient temperature and humidity. Gang-mounting two or more Temperature Controllers, or mounting Temperature Controllers above each other may cause heat to build up inside the Temperature Controllers, which will shorten their service life. In such a case, use forced cooling by fans or other means of air ventilation to cool down the Temperature Controllers.
- To allow heat to escape, do not block the area around the product. Do not block the ventilation holes on the product.
- Be sure to wire properly with correct polarity of terminals.
- Use the specified size (M3.5, width 7.2 mm or less) crimped terminals for wiring. To connect bare wires to the terminal block, use stranded or solid copper wires with a gage of AWG24 to AWG14 (equal to a cross-sectional area of 0.205 to 2.081 mm<sup>2</sup>). (The stripping length is 5 to 6 mm.) Up to two wires or two crimp terminals can be inserted into a single terminal.
- Do not wire the terminals that are not used.
- To avoid inductive noise, keep the wiring for the product's terminal block away from power cables carry high voltages or large currents. Also, do not wire power lines together with or parallel to product wiring. Using shielded cables and using separate conduits or ducts is recommended. Attach a surge suppressor or noise filter to peripheral devices that generate noise (in particular, motors, transformers, solenoids, magnetic coils, or other equipment that have an inductance component).  
When a noise filter is used at the power supply, first check the voltage or current, and attach the noise filter as close as possible to the product.  
Allow as much space as possible between the product and devices that generate powerful high frequencies (high-frequency welders, high-frequency sewing machines, etc.) or surge.
- Use this product within the rated load and power supply.
- Make sure that the rated voltage is attained within two seconds of turning ON the power using a switch or relay contact. If the voltage is applied gradually, the power may not be reset or output malfunctions may occur.
- Make sure that the Temperature Controller has 30 minutes or more to warm up after turning ON the power before starting actual control operations to ensure the correct temperature display.
- When executing self-tuning, turn ON power to the load (e.g., heater) at the same time as or before supplying power to the product. If power is turned ON to the product before turning ON power to the load, self-tuning will not be performed properly and optimum control will not be achieved.
- A switch or circuit breaker must be provided close to the product. The switch or circuit breaker must be within easy reach of the operator, and must be marked as a disconnecting means for this unit.
- Always turn OFF the power supply before pulling out the interior of the product, and never touch nor apply shock to the terminals or electronic components. When inserting the interior of the product, do not allow the electronic components to touch the case.
- Do not use paint thinner or similar chemical to clean with. Use standard grade alcohol.

- Design the system (e.g., control panel) considering the 2 seconds of delay that the product's output to be set after power ON.
- The output may turn OFF when shifting to certain levels. Take this into consideration when performing control.
- The EEPROM has a limited write life. When overwriting data frequently, e.g., via communications, use RAM Mode.
- Check the orientation of the connectors on the Conversion Cable before connecting the Conversion Cable. Do not force a connector if it does not connect smoothly. Using excessive force may damage the connector.
- Do not place heavy object on the Conversion Cable, bend the cable past its natural bending radius, or pull on the cable with undue force.
- Do not connect or disconnect the Conversion Cable while communications are in progress. Product faults or malfunction may occur.
- Make sure that the Conversion Cable's metal components are not touching the external power terminals.
- Do not touch the connectors on the Conversion Cable with wet hands. Electrical shock may result.

## Precautions for Correct Use

### Service Life

- Use the product within the following temperature and humidity ranges:
  - Temperature: -10 to 55°C (with no icing or condensation)
  - Humidity: 25% to 85%
 If the product is installed inside a control board, the ambient temperature must be kept to under 55°C, including the temperature around the product.
- The service life of electronic devices like Temperature Controllers is determined not only by the number of times the relay is switched but also by the service life of internal electronic components. Component service life is affected by the ambient temperature: the higher the temperature, the shorter the service life and, the lower the temperature, the longer the service life. Therefore, the service life can be extended by lowering the temperature of the Temperature Controller.
- When two or more Temperature Controllers are mounted horizontally close to each other or vertically next to one another, the internal temperature will increase due to heat radiated by the Temperature Controllers and the service life will decrease. In such a case, use forced cooling by fans or other means of air ventilation to cool down the Temperature Controllers. When providing forced cooling, however, be careful not to cool down the terminals sections alone to avoid measurement errors.

### Measurement Accuracy

- When extending or connecting the thermocouple lead wire, be sure to use compensating wires that match the thermocouple types.
- When extending or connecting the lead wire of the platinum resistance thermometer, be sure to use wires that have low resistance and keep the resistance of the three lead wires the same.
- Mount the product so that it is horizontally level.
- If the measurement accuracy is low, check to see if input shift has been set correctly.

### Waterproofing

The degree of protection is as shown below. Sections without any specification on their degree of protection or those with IP□0 are not waterproof.

Front panel: NEMA4X for indoor use (equivalent to IP66)  
 Rear case: IP20, Terminal section: IP00  
 (E5CN-U: Front panel: Equivalent to IP50, rear case: IP20, terminals: IP00)

## Operating Precautions

1. It takes approximately two seconds for the outputs to turn ON from after the power supply is turned ON. Due consideration must be given to this time when incorporating Temperature Controllers in a sequence circuit.
2. When using self-tuning, turn ON power for the load (e.g., heater) at the same time as or before supplying power to the Temperature Controller. If power is turned ON for the Temperature Controller before turning ON power for the load, self-tuning will not be performed properly and optimum control will not be achieved.
3. When starting operation after the Temperature Controller has warmed up, turn OFF the power and then turn it ON again at the same time as turning ON power for the load. (Instead of turning the Temperature Controller OFF and ON again, switching from STOP mode to RUN mode can also be used.)
4. Avoid using the Controller in places near a radio, television set, or wireless installing. These devices can cause radio disturbances which adversely affect the performance of the Controller.

## USB-Serial Conversion Cable

1. The disk that is included with the Conversion Cable is designed for a computer CD-ROM driver. Never attempt to play the disk in a general-purpose audio player.
2. Do not connect or disconnect the Conversion Cable connector repeatedly over a short period of time. The computer may malfunction.
3. After connecting the Conversion Cable to the computer, check the COM port number before starting communications. The computer requires time to recognize the cable connection. This delay does not indicate failure.
4. Do not connect the Conversion Cable through a USB hub. Doing so may damage the Conversion Cable.
5. Do not use an extension cable to extend the Conversion Cable length when connecting to the computer. Doing so may damage the Conversion Cable.
6. For models with communications, the same port is used by the Setting Tool port and for communications via the communications terminals. Do not use communications via the communications terminals when using the Setting Tool port.

## Mounting

### Mounting to a Panel

For waterproof mounting, waterproof packing must be installed on the Controller. Waterproofing is not possible when group mounting several Controllers. Waterproof packing is not necessary when there is no need for the waterproofing function.

#### E5CN

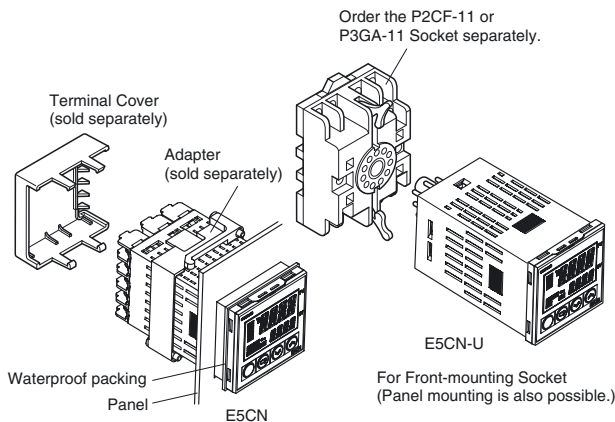

1. The Panel Mounting Adapter is also included with the E5CN-U. There is no waterproof packing included with the E5CN-U.
2. Insert the E5CN/E5CN-U into the mounting hole in the panel.

3. Push the adapter from the terminals up to the panel, and temporarily fasten the E5CN/E5CN-U.
4. Tighten the two fastening screws on the adapter. Alternately tighten the two screws little by little to maintain a balance. Tighten the screws to a torque of 0.29 to 0.39 N·m.

#### E5EN/E5AN

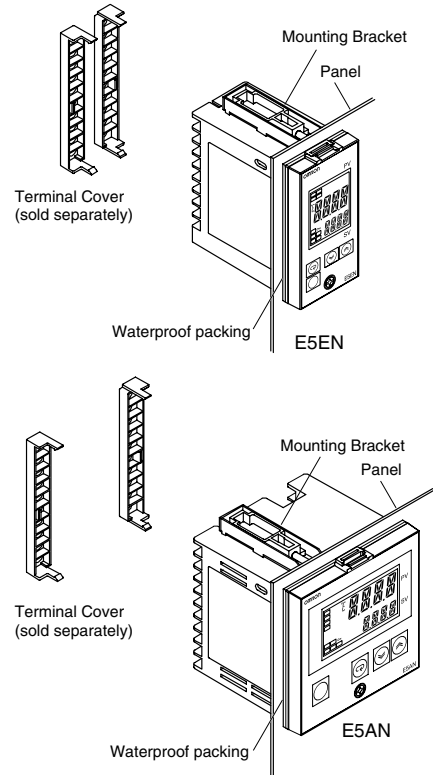

1. Insert the E5AN/E5EN into the square mounting hole in the panel (thickness: 1 to 8 mm). Attach the Mounting Brackets provided with the product to the mounting grooves on the top and bottom surfaces of the rear case.
2. Use a ratchet to alternately tighten the screws on the top and bottom Mounting Brackets little by little to maintain balance, until the ratchet turns freely.

### Mounting the Terminal Cover

For the E5CN, make sure the "UP" characters on the Cover are in the correct position and insert the Cover into the holes at the top and bottom.

For the E5EN or E5AN, fit the E53-COV11 Terminal Cover over the upper hook. Mount it in the direction shown in the above diagram. If the Terminal Cover is mounted in the opposite direction, proper mounting of the fixtures may not be possible.

## Removing the Temperature Controller from the Case

### E5CN

The Temperature Controller can be removed from the case to perform maintenance without removing the terminal leads. This is possible for only the E5CN, and not for the E5CN-U.

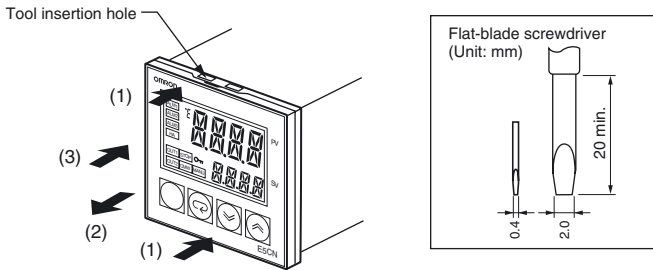

1. Insert the tool into the two tool insertion holes (one on the top and one on the bottom) and release the hooks.
2. Insert the tool in the gap between the front panel and rear case, and pull out the front panel slightly. Hold the top and bottom of the front panel and carefully pull it out toward you, without applying unnecessary force.
3. When inserting the E5CN, check to make sure that the sealing rubber is in place and push the E5CN toward the rear case until it snaps into position. While pushing the E5CN into place, push down on the hooks on the top and bottom surfaces of the rear case so that the hooks are securely locked in place. Be sure that electronic components do not come into contact with the case.

### E5EN/E5AN

Prepare a Phillips screwdriver suitable for the screw on the front panel to remove the Temperature Controller.

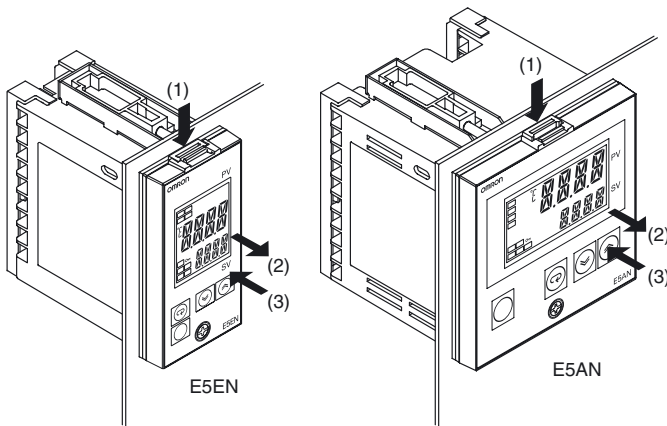

1. Push on the hooks on the top of the front panel, and at the same time, turn the Phillips screwdriver to the left to loosen the screw on the bottom of the front panel.
2. Pull out the front panel gripping both sides.
3. When inserting the E5AN/E5EN Temperature Controller, check to make sure that the sealing rubber is in place. Then, while pushing the front panel into place, turn the Phillips screwdriver to the right in the opposite direction used when removing the panel to tighten the screws on the top and bottom surfaces (tightening torque: 0.3 to 0.5 N·m). Make sure that electronic components do not come into contact with the case.

## Precautions when Wiring

- Separate input leads and power lines in order to prevent external noise.
- Use wires with a gage of AWG24 (cross-sectional area: 0.205 mm<sup>2</sup>) to AWG14 (cross-sectional area: 2.081 mm<sup>2</sup>) twisted-pair cable (stripping length: 5 to 6 mm).
- Use crimp terminals when wiring the terminals.

- Tighten the terminal screws to a torque of 1.13 to 1.36 N·m.
- Use the following types of crimp terminals for M3.5 screws.



- Do not remove the terminal block. Doing so will result in malfunction or failure.



ALL DIMENSIONS SHOWN ARE IN MILLIMETERS.

To convert millimeters into inches, multiply by 0.03937. To convert grams into ounces, multiply by 0.03527.

Cat. No. H136-E2-01-X

**In the interest of product improvement, specifications are subject to change without notice.**

---

## **OMRON EUROPE B.V.**

Wegalaan 67-69,  
NL-2132 JD, Hoofddorp,  
The Netherlands  
Phone: +31 23 568 13 00  
Fax: +31 23 568 13 88  
[www.eu.omron.com](http://www.eu.omron.com)

---