

Contents

EASY control relay, MFD-Titan

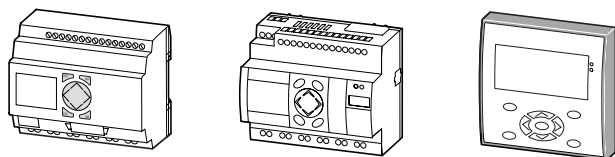

	Page
System overview	4/2
Description	4/4
EASY800 networking	4/4
EASY control relay	4/5
Basic units	4/5
Expansion units	4/9
Multi-function display	4/8
Display/operator unit	4/8
Power supply/CPU modules	4/8
I/O modules	4/8
Accessories	4/9
Documentation	4/11
Technical data	4/12
Dimensions	4/36



System overview EASY control relay

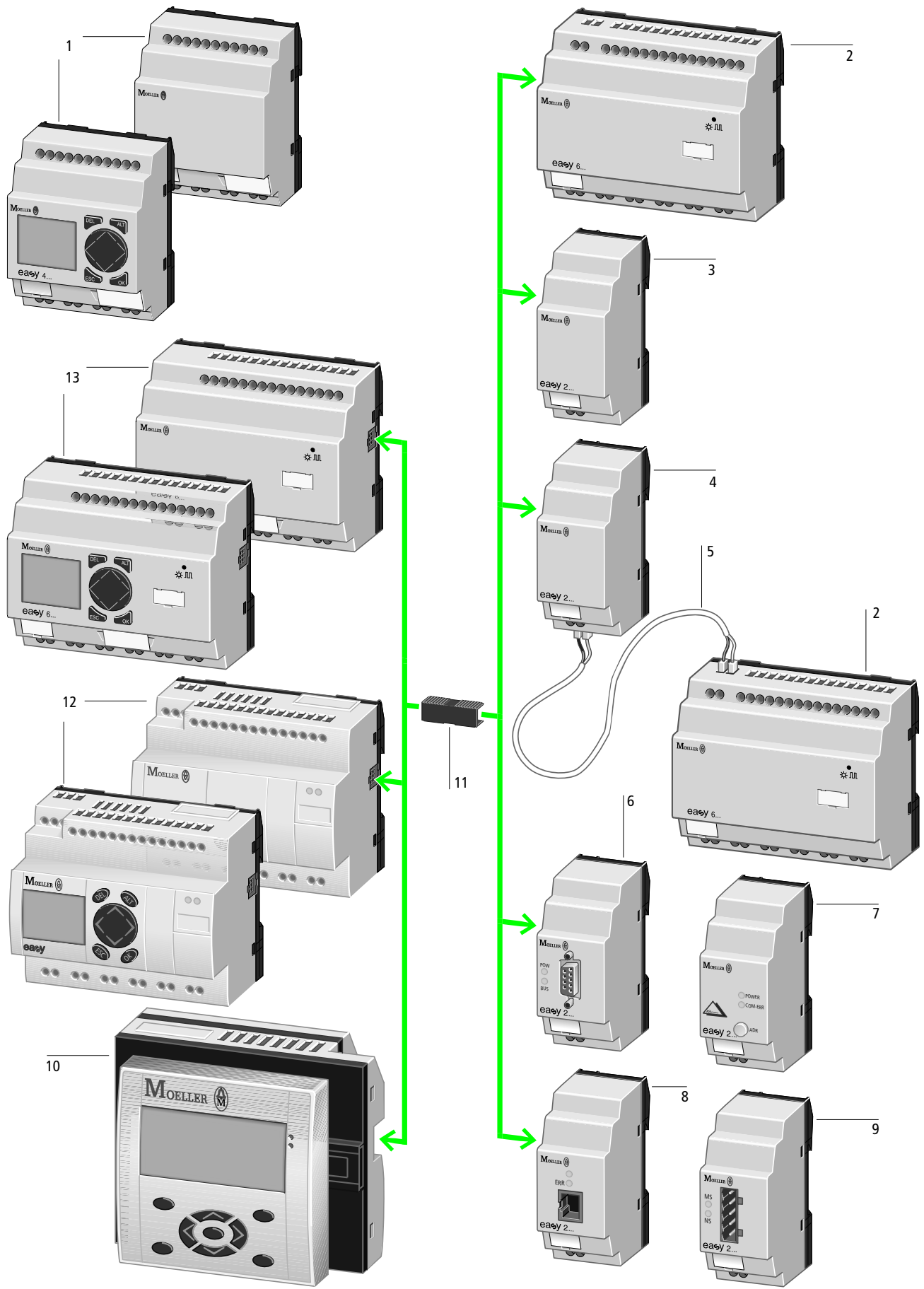

System overview

EASY control relay

Basic units 1	Networking / bus interfaces 9	Features of the easy control relay, MFD-Titan
AC or DC operated	EASY222-DN	<ul style="list-style-type: none"> Wide operational temperature range -25 °C to +55 °C Standard front dimension for fitting into service distribution boards, 18 mm space unit Electronic wiring via pushbuttons, LCD lines, LCD and keypad or software (PC) Internal and external saving of circuit diagram in EEPROM memory 3 contacts (easy400, easy600), 4 contacts (easy800) (make or break contacts) in series plus one coil per circuit connection Series and parallel connection 41 circuit connections, easy412 121 circuit connections, easy600 256 circuit connections, easy800, MFD-Titan Integral password protection for circuit diagram and relay value presets Power flow display for testing the circuit diagram (LCD types) Ten menu languages (easy600, easy800), MFD-Titan and five menu languages (easy412) D, GB, F, I, E, (P, NL, S, PL, TR) LCD versions allow the circuit diagram to be saved on a memory card
Power supply AC 100 (115) – 240 V, 50/60 Hz DC 24 V DC DA 12 V DC	DeviceNet interface (in preparation for easy800, MFD-Titan) PROFIBUS-DP slave connection	
8 digital inputs (2 inputs usable as analog inputs [DC/DA versions only])	→ Page 4/9	
4 relay outputs (max. 10 A)	MFD-Titan®, expandable 10	
4 transistor outputs	DC operated	
LCD display, X versions without LCD	Power supply 24 V DC	
Screw fixing and snap fitting	12 digital inputs (4 inputs usable as analog inputs [DC versions only])	
Screw terminals	4 relay outputs (max. 10 A)	
→ Page 4/5	4 transistor outputs	
Expansion device 2	1 analog output 0 – 10 V (10 Bit)	
I/O expansion	LCD display, full-graphic capability, monochrome	
AC or DC operated	Screw and top-hat rail fitting (2 × 22.5 mm, the display is fitted with two mounting rings)	
Power supply AC 100 – 240 V, 50/60 Hz DC 24 V DC	Cage-clamp spring-loaded terminals	
12 digital inputs	NET network integrated	
6 relay outputs (max. 10 A)	→ Page 4/8	
8 transistor outputs	EASY-LINK-DS data plug 11	
Screw fixing and snap fitting	For connecting the basic unit with the expansion unit	
Screw terminals	→ Page 4/10	
→ Page 4/9	Basic units, expandable easy819, ...822 12	
Expansion device 3	As with easy600 but with additional: 4 analog inputs usable easy-Net interface high-speed counter frequency counter incremental encoder 1 analog output (optional)	
EASY202-RE	→ Page 4/5	
Output expansion	Basic units, expandable easy619/621 13	
2 relay outputs (max. 10 A)	AC or DC operated	
Screw fixing and snap fitting	Power supply AC 100 – 240 V, 50/60 Hz DC 24 V DC	
Screw terminals	12 digital inputs (2 inputs usable as analog inputs [DC versions only])	
→ Page 4/9	6 relay outputs (max. 10 A)	
Coupling unit 4	8 transistor outputs	
→ Page 4/9	LCD display, X versions without LCD	
Connection cable 5	Screw fixing and snap fitting	
e.g. NYM 3 × 1.5 mm ²	Screw terminals	
Networking / bus interfaces 6	→ Page 4/5	
EASY204-DP (in preparation for easy800, MFD-Titan) PROFIBUS-DP slave connection	Networking / bus interfaces 7	
→ Page 4/9	EASY205-ASI AS-Interface slave connection	
Networking / bus interfaces 7	→ Page 4/9	
EASY221-CO CANopen interface (in preparation for easy800, MFD-Titan) PROFIBUS-DP slave connection	Networking / bus interfaces 8	
→ Page 4/9	EASY221-CO CANopen interface (in preparation for easy800, MFD-Titan) PROFIBUS-DP slave connection	
	→ Page 4/9	
		<ul style="list-style-type: none"> 8 timing relays 0.01 s to 99 h 59 min <ul style="list-style-type: none"> On-delay On-delay, random switching Off-delayed Off-delayed with random switching Single pulse Flashing 32 timing relays (easy800) <ul style="list-style-type: none"> On-delayed On-delayed, random switching Off-delayed Off-delayed with random switching On and off-delayed, random switching Single pulse Flashing 8 up and down counter relays, 0000 to 9999 32 counter relays (easy800) <ul style="list-style-type: none"> Value range ± 2³¹ 4 frequency counters (easy800) <ul style="list-style-type: none"> Max. counter frequency ~5kHz/3 kHz MFD 4 high-speed counters 4(easy800) <ul style="list-style-type: none"> Max. counter frequency ~5kHz/3 kHz MFD 2 incremental encoders (easy800) <ul style="list-style-type: none"> Max. counter frequency ~3kHz/2 kHz MFD 4 operating hours counters (easy800), retentive 4 seven-day time switches (4 channels per time switch, one On/Off point per channel, optional on types with clock) 32 seven-day time switches (easy800), (4 channels per time switch, one ON/OFF point per channel) 32 year time switches (easy800), (4 channels per time switch, one ON/OFF point per channel) 8 analog value comparators range 0 – 10 V (only easy4..-D..-, easy6..-D..- types) 32 analog value comparators, range 0 – 10 V (easy8..-D... types only) 8 user-definable text displays easy600 with LCD), using EASY-SOFT 32 user-definable text displays (not MFD) (easy800 with LCD display), using EASY-SOFT 16 auxiliary relays (easy412), up to 32 auxiliary relays (easy600) 96 markers (easy800) 32 arithmetic function blocks (easy800) <ul style="list-style-type: none"> ADD; SUB; MUL; DIV 32 Boolean sequences (easy800) <ul style="list-style-type: none"> AND; NOT; OR Retentive actual values easy412-D... <ul style="list-style-type: none"> 4 markers, 1 timing relay, 1 counter Retentive actual values easy600 <ul style="list-style-type: none"> 12 markers, 2 timing relays, 4 counters (e.g. for operating hours counters) Retentive actual values easy800 <ul style="list-style-type: none"> 184 bytes possible, Data = MB (marker byte), function blocks = C; CF; CH; CI; DB; T, i.e. 80 MB and up to 40 function blocks depending on memory required 4 operating hours counters 0 to 10⁶ hours (resolution: minutes)



Description

easy800 control relay

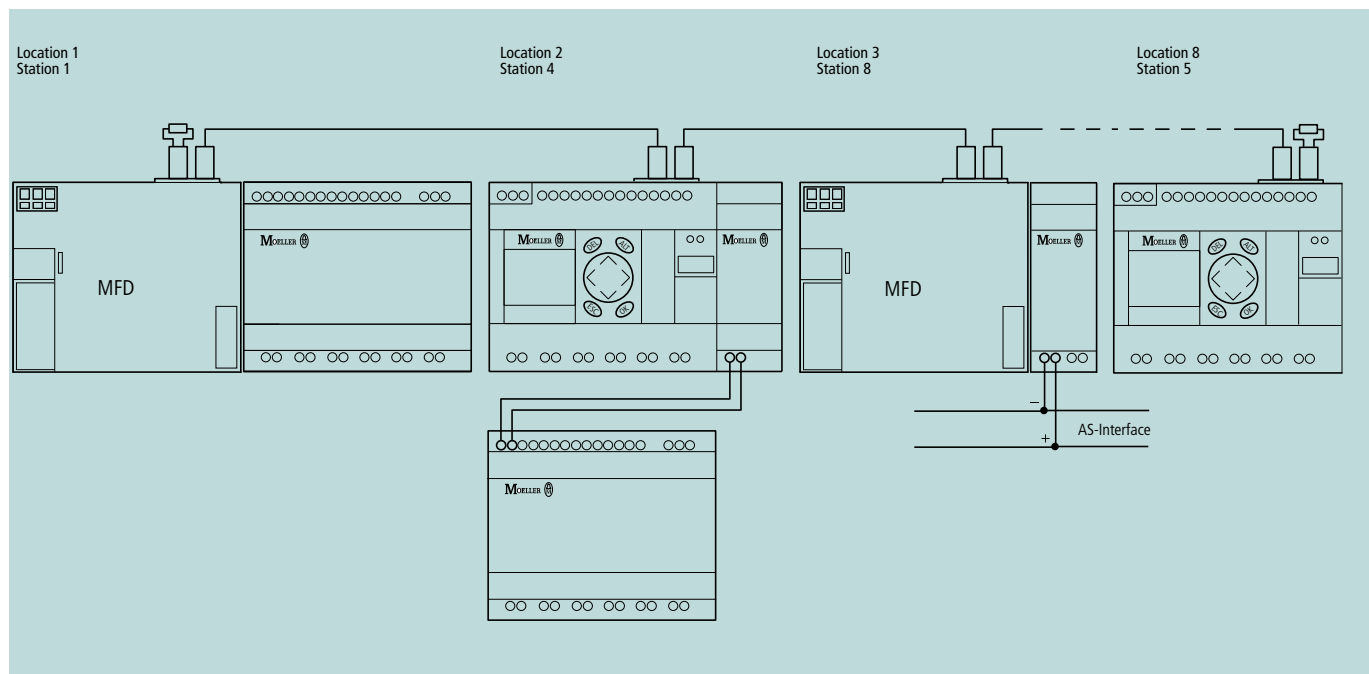

Networking

Addressing the stations:

If all stations are connected, the addresses can be assigned automatically, each station number assigned on the basis of geographical location. Stations can also be addressed individually. The geographical address does not have to match the station address.

Example of a network topology:

4 stations are interconnected. Station address 1 is always the first location. All other station addresses do not have to match the geographical location.

Technical data

- A total of 320 digital inputs and outputs are possible
- 8 stations
- Baud rate: 10 kBit/s to 1000 kBit/s
- Length: up to 1000 m possible
- Modes
 - 1 master (location 1, station address 1), 7 I/O stations
 - Up to
 - 1 master (location 1, station address 1) and 7 intelligent stations
- Transfer of up to 32 double words
- Synchronise time, date
- Direct access to inputs/outputs
- Upload/download program via NET



EASY control relays

Basic units



Description		Type Article no.	Price See Price List	Std. pack
Basic units				
	24 V DC, retentive	<ul style="list-style-type: none"> • 8 digital inputs (2 inputs available as analog inputs) • 4 relay outputs • LCD display • Operating buttons • Screw terminals 	EASY412-DC-R 202403	1 off
		Features same as EASY-412-DC-R, additional time switch	EASY412-DC-RC 202404	
		Features same as EASY-412-DC-RC, without keypad and LCD display	EASY412-DC-RCX 221596	
		<ul style="list-style-type: none"> • 8 digital inputs (2 inputs available as analog inputs) • 4 transistor outputs • LCD display • Operating buttons • Screw terminals • Time switch 	EASY412-DC-TC 207808	
		Features same as EASY412-DC-TC, without keypad and LCD display	EASY412-DC-TCX 212307	
		<ul style="list-style-type: none"> • 12 digital inputs (2 inputs available as analog inputs) • 6 relay outputs • LCD display • Operating buttons • Screw terminals • Time switch • Can be expanded using EASY expansion units 	EASY619-DC-RC 224473	
		Features same as EASY619-DC-RC, without keypad and LCD display	EASY619-DC-RCX 224474	
		<ul style="list-style-type: none"> • 12 digital inputs (2 inputs available as analog inputs) • 8 transistor outputs • LCD display • Operating buttons • Screw terminals • Time switch • Can be expanded using EASY expansion units 	EASY621-DC-TC 218719	
		Features same as EASY621-DC-TC, without keypad and LCD display	EASY621-DC-TCX 212311	
		<ul style="list-style-type: none"> • 12 digital inputs (4 inputs available as analog inputs) • 6 relay outputs • LCD display • Operating buttons • Screw terminals • Time switch • Can be expanded using EASY expansion units 	EASY819-DC-RC 256269	
		Features same as EASY819-DC-RC, without keypad and LCD display	EASY819-DC-RCX 256270	

Notes

Backup of real-time clock (only for appropriate devices)

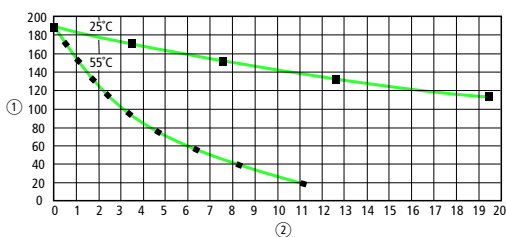

- ① Backup time (hours)
- ② Operating time (years)

EASY control relays

Basic units

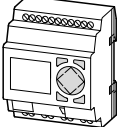
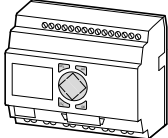
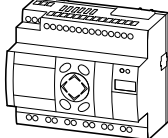
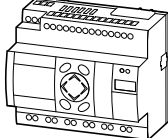

	Description	Type Article no.	Price See Price List	Std. pack
Basic units				
   	<p>24 V DC, retentive</p> <ul style="list-style-type: none"> • 12 digital inputs (4 inputs available as analog inputs) • 6 relay outputs • 1 analog output • LCD display • Operating buttons • Screw terminals • Time switch • Can be expanded using EASY expansion units <p>Features same as EASY820-DC-RC, without keypad and LCD display</p> <ul style="list-style-type: none"> • 12 digital inputs (4 inputs available as analog inputs) • 8 transistor outputs • LCD display • Operating buttons • Screw terminals • Time switch • Can be expanded using EASY expansion units <p>Features same as EASY821-DC-TC, without keypad and LCD display</p> <ul style="list-style-type: none"> • 12 digital inputs (4 inputs available as analog inputs) • 8 transistor outputs • 1 analog output • LCD display • Operating buttons • Screw terminals • Time switch • Can be expanded using EASY expansion units <p>Features same as EASY822-DC-TC, without keypad and LCD display</p>	<p>EASY820-DC-RC 256271</p> <p>EASY820-DC-RCX 256272</p> <p>EASY821-DC-TC 256273</p> <p>EASY821-DC-TCX 256274</p> <p>EASY822-DC-TC 256275</p> <p>EASY822-DC-TCX 256276</p>		<p>1 off</p>
	<p>12 V DC, retentive</p> <ul style="list-style-type: none"> • 8 digital inputs (2 inputs available as analog inputs) • 4 relay outputs • LCD display • Operating buttons • Screw terminals • Time switch 	<p>EASY412-DA-RC 224471</p>		<p>1 off</p>

Notes

Backup of real-time clock (only for appropriate devices)

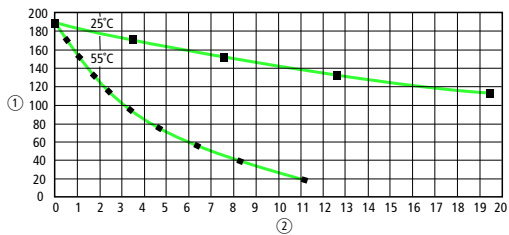

① Backup time (hours)

② Operating time (years)

EASY control relays

Basic units

EASY control relays, MFD-Titan

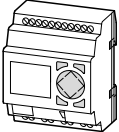
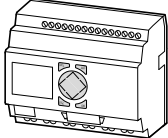
Description		Type Article no.	Price See Price List	Std. pack
Basic units				
	115/230 V AC	<ul style="list-style-type: none"> • 8 digital inputs • 4 relay outputs • LCD display • Operating buttons • Screw terminals 	EASY412-AC-R 202405	1 off
		Features same as EASY-412-AC-R, additional time switch	EASY412-AC-RC 202406	
		Features same as EASY412-AC-RC, without keypad and LCD display	EASY412-AC-RCX 212308	
	115/230 V AC, retentive	<ul style="list-style-type: none"> • 12 digital inputs • 6 relay outputs • LCD display • Operating buttons • Screw terminals • Time switch • Can be expanded using EASY expansion units • Replaces EASY618-AC-RC 	EASY619-AC-RC 218721	1 off
		Features same as EASY619-AC-RC, without keypad and LCD display	EASY619-AC-RCX 212312	
		<ul style="list-style-type: none"> • 12 digital inputs • 6 relay outputs • LCD display • Operating buttons • Screw terminals • Time switch • Can be expanded using EASY expansion units 	EASY819-AC-RC 256267	
		Features same as EASY819-AC-RC, without keypad and LCD display	EASY819-AC-RCX 256268	



Notes

Backup of real-time clock (only for appropriate devices)

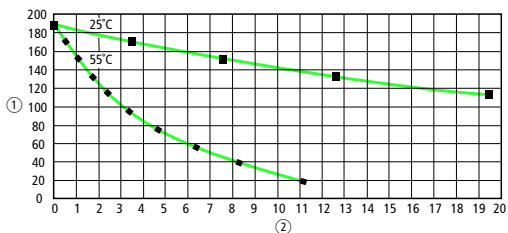



- ① Backup time (hours)
- ② Operating time (years)

EASY control relays, MFD-Titan

Expansion units

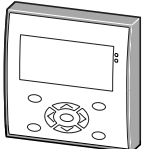

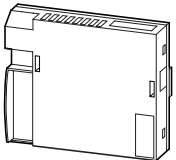
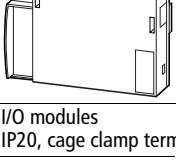
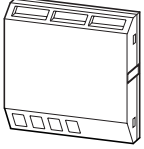
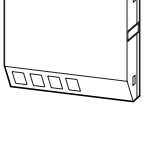
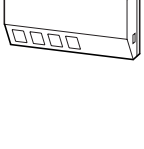
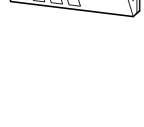
Description	Type Article no.	Price See Price List	Std. pack
Multi-function display			
Operator interface module Graphical display 132 × 64 pixels Switchable backlight Freely definable status LEDs red + green Individual laser inscription via MFD combination* Removable Titan front frame			
 NEMA 4X; IP65	MFD-80 265250		1 off
 NEMA 3R, 12; IP65 Illuminated keypad with: 4 cursor buttons 4 function buttons 1 mode button	MFD-80-B 265251		1 off
Individual laser inscription For MFD-80(-B)			
Inscription using the inscription editor in EASY-SOFT-PRO or only the inscription editor, download → www.moeller.net	MFD-COMBINATION-* 265260		1 off
Control module/CPU, Power supply 24 V DC, IP20			
 Cage clamp terminals Serial interface Suitable for connection of Easy expansions	MFD-CP8-ME 267164		1 off
 Cage clamp terminals Serial interface Suitable for connection of Easy expansions Optional easy-NET network	MFD-CP8-NT 265253		1 off
I/O modules IP20, cage clamp terminals			
 12 digital inputs (4 inputs available as analog inputs) 4 relay outputs	MFD-R16 265254		1 off
 12 digital inputs (4 inputs available as analog inputs) 4 transistor outputs	MFD-T16 265255		
 12 digital inputs (4 inputs available as analog inputs) 4 relay outputs 1 analog output	MFD-RA17 265364		
 12 digital inputs (4 inputs available as analog inputs) 4 transistor outputs 1 analog output	MFD-TA17 265256		

Notes

Backup/accuracy of real-time clock (only for appropriate devices)

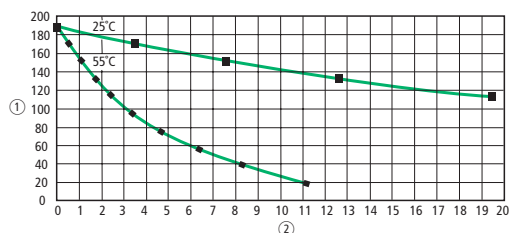

① Backup time (hours)

② Operating time (years)

EASY control relays, MFD-Titan

Networking, accessories

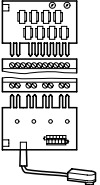
Description	Type Article no.	Price See Price List	Std. pack
Expansion units			
24 V DC			
<ul style="list-style-type: none"> • 12 digital inputs • 8 transistor outputs 	EASY620-DC-TE 212313		1 off
<ul style="list-style-type: none"> • 12 digital inputs • 6 relay outputs 	EASY618-DC-RE 232112		1 off
115/230 V AC			
<ul style="list-style-type: none"> • 12 digital inputs • 6 relay outputs 	EASY618-AC-RE 212314		1 off
Without power supply			
<ul style="list-style-type: none"> • 2 relay outputs (common potential) 	EASY202-RE 232186		1 off
Coupling unit			
<ul style="list-style-type: none"> • Coupling unit for connecting to an EASY619/621 basic unit • Terminals for remote expansion, up to 30 m to/from the expansion unit 	EASY200-EASY 212315		1 off
Expansion units for networking			
AS-Interface			
<ul style="list-style-type: none"> • AS-Interface connection • Slave • 4 inputs, 4 outputs, 4 parameter bits • Addresses available: 0 to 31 	EASY205-ASI 221598		1 off
PROFIBUS-DP			
<ul style="list-style-type: none"> • PROFIBUS-DP slave (RefExtrakt) • Addresses available: 1 to 126 	EASY204-DP 212316		1 off
CANopen			
<ul style="list-style-type: none"> • CANopen interface • Addresses available: 1 to 127 	EASY221-CO 233539		1 off
DeviceNet			
<ul style="list-style-type: none"> • DeviceNet interface • Addresses available: 0 to 63 	EASY222-DN 233540		1 off
Accessories			
Software			
easy400, 600, 800 programming and operating software CD, menu selection in 6 languages Installation on WIN 98, WIN NT 4.0 Service Pack 2000 and higher	EASY-SOFT 202407		1 off
Professional version, such as EASY-SOFT, additional programming and visualization of MFD-Titan	EASY-SOFT-PRO 266040		1 off
Memory card			
8K memory card for storing the entire program for EASY412...	EASY-M-8K 202408		1 off
16K memory card for storing the entire program for EASY6...	EASY-M-16K 212317		1 off
256K module for storing the entire EASY program for EASY8... and the entire MFD-Titan program	EASY-M-256K 256279		1 off
PC programming cable			
2 m length, for connection to 9-pole serial PC interface with interface electronics for EASY412... and EASY6...	EASY-PC-CAB 202409		1 off
2 m length, for connection to 9-pole serial PC interface with interface electronics for EASY8... and MFD-Titan	EASY800-PC-CAB 256277		1 off
Input/output simulator			
 Simulator with power supply unit, 115/230 V AC / 24 V DC output, suitable for EASY412-DC...	EASY412-DC-SIM 212318		1 off
Same as EASY412-DC-SIM, with plug-in power supply unit, 120 V AC/24 V DC output, plug suitable for North America	EASY412-DC-SIM-NA 222566		1 off



EASY control relays

Networking, accessories

Description	Type Article no.	Price See Price List	Std. pack
Accessories			
Fixing bracket for screw fixing on an mounting plate			
For screw fixing onto mounting plate: <ul style="list-style-type: none"> • 3 brackets per EASY4... • 3 brackets per EASY6... • 3 brackets per EASY8... • 2 brackets per EASY2... • 3 brackets per MFD-CP8.. 	ZB4-101-GF1 061360		9 off
Coupling piece			
Spare link between basic unit and expansion units	EASY-LINK-DS 221607		1 off
Telescopic clip			
With 35 mm top-hat rail to EN 50022 for equalization of the mounting depth of rear mounted devices in CI-K... enclosures and cabinets. Adjustable as required via scales of 75 – 115 mm. Screw and snap fastener (also suitable for PKZM0, FAZ, FIP, ETR, EMR4, etc.)	M22-TA 226161		1 off
Switched-mode power supply unit Primary-switched mode, stabilized			
<ul style="list-style-type: none"> • Rated input voltage: 50/60 Hz: 115/230 V • Rated output voltage: 24 V/12 V • Rated output current: 0.25 A/20 A 	EASY200-POW 229424		1 off
<ul style="list-style-type: none"> • Rated input voltage: 50/60 Hz: 115/230 V AC • Rated output voltage (residual ripple): 24 V DC (± 3 %) • Rated output current: 1.25 A 	EASY400-POW 212319		1 off
Upstream device To increase the AC input current			
<ul style="list-style-type: none"> • 6 channels 	EASY256-HCI 231168		1 off
Network connection cable (remote coupling) Completely prepared for EASY8... NET			
Length: 0.3 m	EASY-NT-30 256283		5 off
Length: 0.8 m	EASY-NT-80 256284		3 off
Length: 1.5 m	EASY-NT-150 256285		2 off
Data cable			
<ul style="list-style-type: none"> • 4-wire • 4 × 0.14 mm², twisted pair, AWG 26 • Length 100 m 	EASY-NT-CAB 256286		1 off
Remote coupling			
Bus connector for NET network <ul style="list-style-type: none"> • 8-pole, RJ45 	EASY-NT-RJ45 256280		10 off
Bus terminating resistor, complete with connector for NET	EASY-NT-R 256281		2 off
Crimping tool <ul style="list-style-type: none"> • For 8-pin RJ45 connector 	EASY-RJ45-TOOL 256282		1 off
(SKF) inspection flap window <ul style="list-style-type: none"> • Mounting frame with inspection flap • Material: transparent polycarbonate, UV-resistant • Self-extinguishing to ASTM-D 635/72, UNE 53315-75, UNE 20672/83 (2-1) and IEC-695-2-1 • Degree of protection IP65 to IEC-144 and 525 			
<ul style="list-style-type: none"> • 94 mm × 77 mm × 25 mm (4 space units) 	SKF-FF4 233780		1 off
<ul style="list-style-type: none"> • 130 mm × 77 mm × 25 mm (6 space units) 	SKF-FF6 233781		1 off

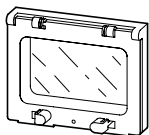

EASY control relays

Documentation

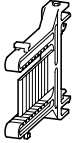
Description	Type Article no.	Price See Price List	Std. pack
Accessories			
Top-hat rail adapter for inspection flap window  <ul style="list-style-type: none"> • 12 mm × 66 mm × 82 mm • Mounting on inspection flap window with front mounting units 	SKF-HA 233782		2 off
PROFIBUS-DP bus connector plug <ul style="list-style-type: none"> • 9-pole (male), • Kit without cable for connecting the data cable for PROFIBUS-DP 	ZB4-209-DS2 206982		1 off
<ul style="list-style-type: none"> • Metallised insulated housing • Maximum transfer rate 12 MBit/s • Integrated switch (accessible from the outside) for the bus terminating resistors • Terminal block for two cable inputs, optionally with straight or 90° angled cable entry • Suitable for EASY204-DP 	ZB4-209-DS3 217820		1 off
PROFIBUS DP data cable <ul style="list-style-type: none"> • 2-wire • 2 × 0.64 mm² twisted • Length 100 m 	ZB4-900-KB1 206983		100 off
Protective cover, transparent For MFD-Titan multi-function display can be rotated by 4 × 90° Sealing facility for protection against accidental actuation (without RMQ-Titan front frame)	MFD-XS-80 265259		1 off
Protective membrane For MFD-Titan multi-function display Transparent diaphragms for severe environmental conditions and use in the food industry.	MFD-XM-80 265258		1 off
Connection cable For connecting MFD-Titan to EASY800 or MFD-Titan to MFD-Titan 2 m long, made up	MFD-800-CAB 265257		1 off
5 m long, can be prepared as required, with separate plug	MFD-800-CAB5 266041		1 off

	Language	Type Article no.	Price See Price List	Std. pack
Documentation				
Manual for the EASY400/600 control relay	German	AWB2528-1304-D 205375		30 off –
	English	AWB2528-1304-GB 205481		50 off –
	French	AWB2528-1304-F 205482		1 off –
	Italian	AWB2528-1304-I 205483		–
	Spanish	AWB2528-1304-E 205484		–
Manual for the EASY800 control relay	German	AWB2528-1423D 261371		1 off Other languages in preparation.
Manual for the EASY800 control relay	English	AWB2528-1423GB 262671		1 off Other languages in preparation.
Manual for the MFD-Titan	German	AWB2528-1480D 267187		1 off –
Manual for the MFD-Titan	English	AWB2528-1480GB 267188		1 off –



Technical data

			EASY200-EASY EASY202-RE	EASY412-...
General				
Standards			EN 55011, EN 55022, EN 61000-4, IEC 60068-2-6, IEC 60068-2-27	
Dimensions (W × H × D)		mm	35.5 × 90 × 58 (2 space units)	71.5 × 90 × 58 (4 space units)
Weight		kg	0.07	0.2
Mounting			EN 50022 top-hat rail, 35 mm or screw fixing with ZB4-101-GF1fixing brackets (accessories)	
Terminal capacities				
Solid		mm ²	0.2 / 4 (AWG 22 – 12)	0.2 / 4 (AWG 22 – 12)
Flexible with ferrule		mm ²	0.2 / 2.5 (AWG 22 – 12)	0.2 / 2.5 (AWG 22 – 12)
Standard screwdriver		mm	3.5 × 0.8	3.5 × 0.8
max. tightening torque		Nm	0.6	0.6
Climatic environmental conditions				
Operating ambient temperature		°C	-25/+ 55, low temperatures to IEC 60068-2-1, high temperatures to IEC 60068-2-2	
Condensation			Prevent condensation by means of suitable measures	
LCD display (clearly legible)		°C	0 – 55	0 – 55
Storage		°C	-40 – 70	-40 – 70
Relative humidity, non-condensing (IEC/EN 60068-2-30)		%	5 – 95	5 – 95
Air pressure (operation)		hPa	795 – 1080	795 – 1080
Corrosion resistance				
IEC/EN 60068-2-42	4 days SO ₂	cm ³ /m ³	10	10
IEC/EN 60068-2-43	4 days H ₂ S	cm ³ /m ³	1	1
Ambient conditions, mechanical				
Pollution degree			2	2
Degree of protection (IEC/EN 60529)			IP20	IP20
Vibrations (IEC/EN 60068-2-6)				
Constant amplitude 0.15 mm		Hz	10 – 57	10 – 57
Constant acceleration 2 g		Hz	57 – 150	57 – 150
Mechanical shock resistance (IEC/EN 60068-2-27) semi-sinusoidal 15 g/11 ms		Impacts	18	18
Drop to IEC/EN 60068-2-31	Drop height	mm	50	50
Free fall, packaged (IEC/EN 60068-2-32)		m	1	1
Mounting position			horizontal, vertical	horizontal, vertical
Electromagnetic compatibility (EMC)				
Electrostatic discharge (IEC/EN 61000-4-2, Level 3, ESD)				
Air discharge		kV	8	8
Contact discharge		kV	6	6
Electromagnetic fields (IEC/EN 61000-4-3, RFI)		V/m	10	10
Radio interference suppression (EN 55011)			EN 55011 Class B, EN 55022 Class B	
Burst pulses (IEC/EN 61000-4-4, level 3)				
Supply cables		kV	2	2
Signal lines		kV	2	2
High-energy pulses (surge) (IEC/EN 61000-4-5)		kV	2 (supply cables, symmetrical, EASY...AC)	
High-energy pulses (surge) (IEC/EN 61000-4-5, level 2)		kV	0.5 (supply cables, symmetrical, EASY...DC)	
Immunity to line-conducted interference to (IEC/EN 61000-4-6)		V	10	10
Insulation resistance				
Clearance in air and creepage distances			EN 50178, UL 508, CSA C22.2, No. 142	
Insulation resistance			EN 50178	EN 50178
Back-up/accuracy of the real-time clock				
Back-up of the real-time clock			–	→ Page 5
Accuracy of the real-time clock			–	Normally ± 5 (± 0.5 h / year)
Repetition accuracy of timing relays				
Accuracy of timing relays (of values)		%	–	± 1
Resolution				
Range "S"		ms	–	10
Range "M:S"		s	–	1
Range "H:M"		min	–	1
Retentive memory				
Write cycles of the retentive memory			–	≥ 10000

Notes

For more technical data for EASY4... and EASY6... → AWB2528-1508D, EASY8... → AWB2528-1423D

Technical data

			EASY6...-...	EASY8...-...
General				
Standards			EN 55011, EN 55022, EN 61000-4, IEC 60068-2-6, IEC 60068-2-27	
Dimensions (W × H × D)		mm	107.5 × 90 × 58 (6 space units)	107.5 × 90 × 72 (6 TE)
Weight		kg	0.3	0.3
Mounting			EN 50022 top-hat rail, 35 mm or screw fixing with ZB4-101-GF1fixing brackets (accessories)	
Terminal capacities				
Solid		mm ²	0.2 / 4 (AWG 22 – 12)	0.2 / 4 (AWG 22 – 12)
Flexible with ferrule		mm ²	0.2 / 2.5 (AWG 22 – 12)	0.2 / 2.5 (AWG 22 – 12)
Standard screwdriver		mm	3.5 × 0.8	3.5 × 0.8
max. tightening torque		Nm	0.6	0.6
Climatic environmental conditions				
Operating ambient temperature		°C	-25/+ 55, low temperatures to IEC 60068-2-1, high temperatures to IEC 60068-2-2	
Condensation			Prevent condensation by means of suitable measures	
LCD display (clearly legible)		°C	0 – 55	0 – 55
Storage		°C	-40 – 70	-40 – 70
Relative humidity, non-condensing (IEC/EN 60068-2-30)		%	5 – 95	5 – 95
Air pressure (operation)		hPa	795 – 1080	795 – 1080
Corrosion resistance				
IEC/EN 60068-2-42	4 days SO ₂	cm ³ /m ³	10	10
IEC/EN 60068-2-43	4 days H ₂ S	cm ³ /m ³	1	1
Ambient conditions, mechanical				
Pollution degree			2	2
Degree of protection (IEC/EN 60529)			IP20	IP20
Vibrations (IEC/EN 60068-2-6)				
Constant amplitude 0.15 mm		Hz	10 – 57	10 – 57
Constant acceleration 2 g		Hz	57 – 150	57 – 150
Mechanical shock resistance (IEC/EN 60068-2-27) semi-sinusoidal 15 g/11 ms		Impacts	18	18
Drop to IEC/EN 60068-2-31	Drop height	mm	50	50
Free fall, packaged (IEC/EN 60068-2-32)		m	1	1
Mounting position			horizontal, vertical	horizontal, vertical
Electromagnetic compatibility (EMC)				
Electrostatic discharge (IEC/EN 61000-4-2, Level 3, ESD)				
Air discharge		kV	8	8
Contact discharge		kV	6	6
Electromagnetic fields (IEC/EN 61000-4-3, RFI)		V/m	10	10
Radio interference suppression (EN 55011)			EN 55011 Class B, EN 55022 Class B	
Burst pulses (IEC/EN 61000-4-4, level 3)				
Supply cables		kV	2	2
Signal lines		kV	2	2
High-energy pulses (surge) (IEC/EN 61000-4-5)		kV	2 (supply cables, symmetrical, EASY...AC)	
High-energy pulses (surge) (IEC/EN 61000-4-5, level 2)		kV	0.5 (supply cables, symmetrical, EASY...DC)	
Immunity to line-conducted interference to (IEC/EN 61000-4-6)		V	10	10
Insulation resistance				
Clearance in air and creepage distances			EN 50178, UL 508, CSA C22.2, No. 142	
Insulation resistance			EN 50178	EN 50178
Backup/accuracy of the real-time clock				
Back-up of the real-time clock			→ Page 5	→ Page 5
Accuracy of the real-time clock			Normally ± 5 (± 0.5 h / year)	Normally ± 5 (± 0.5 h / year)
Repetition accuracy of timing relays				
Accuracy of timing relays (of values)		%	± 1	± 0.02
Resolution				
Range "S"		ms	–	5
Range "M:S"		s	–	1
Range "H:M"		min	–	1
Retentive memory				
Write cycles of the retentive memory			≥ 10000	≥ 10 ¹⁰ (read/write cycles)

Notes

For more technical data for EASY4... and EASY6... → AWB2528-1508D,
EASY8... → AWB2528-1423D

Technical data

			EASY412-AC-...	EASY61.-AC-R..	EASY819-AC-RC.
Power supply					
Rated operational voltage	U_e	V	100/110/115/120/230/240 AC (+10/-15 %)	100/110/115/120/230/240 AC (+10/-15 %)	100/110/115/120/230/240 AC (+10/-15 %)
Admissible range		V AC	90 – 264	85 – 264	85 – 264
Frequency		Hz	50 / 60 (± 5 %)	50 / 60 (± 5 %)	50 / 60 (± 5 %)
Input current					
at 115/120 V AC 60 Hz		mA	Normally 40	–	Normally 70
at 230/240 V AC 50 Hz		mA	Normally 20	Normally 35	Normally 35
Voltage dips (IEC/EN 61131-2)		ms	20	20	20
Power loss					
at 115/120 V AC		VA	Normally 5	Normally 10	Normally 10
at 115/230 V AC		VA	Normally 5	Normally 10	Normally 10
			EASY412-AC-...	EASY618/619-AC-R..	EASY8..-AC-R..
Digital inputs 115/230 V AC					
Number			8	12	12
Status indication			LCD-Display (if provided)	LCD-Display (if provided)	LCD-Display (if provided)
Potential isolation					
From power supply			No	No	No
Between digital inputs			No	No	No
From the outputs			Yes	Yes	Yes
From the PC interface, memory card NET network, EASY-Link			No	No	Yes
Rated voltage L (sinusoidal)					
On 0 signal		V AC	0 – 40	0 – 40	0 – 40
On 1 signal		V AC	79 – 264	79 – 264	79 – 264
Rated frequency		Hz	50 – 60	50 – 60	50 – 60
Input current on 1 signal					
R1 to R12		mA	–	12 × 0.25 (at 115 V AC, 60 Hz) 12 × 0.5 (at 230 V AC, 50 Hz)	–
I1 to I6		mA	6 × 0.25 (at 115 V AC, 60 Hz) 6 × 0.5 (at 230 V AC, 50 Hz)	6 × 0.25 (at 115 V AC, 60 Hz) 6 × 0.5 (at 230 V AC, 50 Hz)	6 × 0.25 (at 115 V AC, 60 Hz) 6 × 0.5 (at 230 V AC, 50 Hz)
I9 to I12		mA	–	4 × 0.25 (at 115 V AC, 60 Hz) 4 × 0.5 (at 230 V AC, 50 Hz)	4 × 0.25 (at 115 V AC, 60 Hz) 4 × 0.5 (at 230 V AC, 50 Hz)
I7 to I8		mA	2 × 4 (at 115 V AC, 60 Hz) 2 × 6 (at 230 V AC, 50 Hz)	2 × 4 (at 115 V AC, 60 Hz) 2 × 6 (at 230 V AC, 50 Hz)	2 × 4 (at 115 V AC, 60 Hz) 2 × 6 (at 230 V AC, 50 Hz)
Delay time					
Delay time (0 – 1/1 – 0) I1 to I6, I9 to I12, R1 to R12					
Debounce ON 50/60 Hz		ms	80 / 66 $\frac{2}{3}$	80 / 66 $\frac{2}{3}$	80 / 66 $\frac{2}{3}$
Debounce OFF 50/60 Hz		ms	20 / 16 $\frac{2}{3}$	20 / 16 $\frac{2}{3}$	20 / 16 $\frac{2}{3}$
Delay time I7, I8 (1 – 0)					
Debounce ON 50/60 Hz		ms	160 / 150	80 / 66 $\frac{2}{3}$	120 / 100
Debounce OFF 50/60 Hz		ms	100 / 100	20 / 16 $\frac{2}{3}$	40 / 33 $\frac{2}{3}$
Delay time I7, I8 (0 – 1)					
Debounce ON 50/60 Hz		ms	80 / 66 $\frac{2}{3}$	80 / 66 $\frac{2}{3}$	80 / 66 $\frac{2}{3}$
Debounce OFF 50/60 Hz		ms	20 / 16 $\frac{2}{3}$	20 / 16 $\frac{2}{3}$	20 / 16 $\frac{2}{3}$
Max. admissible cable length (per input)					
R1 to R12		m	–	Normally 40	–
Resolution, digital I1 to I6		m	Normally 40	Normally 40	Normally 60
I7, I8		m	Normally 100	Normally 100	Normally 100
I9 to I12		m	–	Normally 40	Normally 60

Notes

For more technical data for EASY4... and EASY6... → AWB2528-1508D,
EASY8... → AWB2528-1423D

Technical data

			EASY412-DC-...	EASY412-DA-RC	
Power supply					
Rated operational voltage	U_e	V	12 DC (-15 / +30 %)	12 DC (-15 / +30 %)	
Admissible range		V DC	20.4 – 28.8	10.2 – 15.6	
Residual ripple		%	≤ 5	≤ 5	
Input current					
at 24 V DC		mA	Normally 80	Normally 140	
Voltage dips (IEC/EN 61131-2)		ms	10	10	
Heat dissipation at 24 V DC		W	2	2	
			EASY412-DC-...	EASY412-DA-RC	
Digital inputs 24 V DC					
Number			8	8	
Inputs can be used as analog inputs			I7, I8	I7, I8	
Status indication			LCD display (if provided)	LCD display (if provided)	
Potential isolation					
From power supply			No	No	
Between digital inputs			No	No	
From the outputs			Yes	Yes	
Rated operating voltage					
Rated operational voltage	U_e	V DC	24	12	
On 0 signal	U_e	V DC	< 5.0 (I1 – I8)	< 4.0 (I1 – I8)	
On 1 signal	U_e	V DC	> 15.0 (I1 – I6), > 8.0 (I7, I8) > 15.0 (I1 – I6), > 8.0 (I7, I8)	> 8.0 (I1 – I8)	
Input current on 1 signal					
I1 to I6		mA	3.3 (at 12 V DC)	3.3 (at 12 V DC)	
I7, I8		mA	2.2 (at 24 V DC)	1.1 (at 12 V DC)	
Delay time from 0 to 1					
Debounce ON		ms	20	20	
Debounce OFF		ms	Normally 0.25 (I1 – I6)	Normally 0.3 (I1 – I6), norm. 0.35 (I7, I8), normally 0.3 (I1 – I6), norm. 0.35 (I7, I8)	
Delay time from 1 to 0					
Debounce ON		ms	20	20	
Debounce OFF		ms	Normally 0.4 (I1 – I6), norm. 0.2 (I7, I8) Normally 0.4 (I1 – I6), norm. 0.2 (I7, I8)	Normally 0.3 (I1 – I6), norm. 0.35 (I7, I8) Normally 0.3 (I1 – I6), norm. 0.35 (I7, I8)	
Cable length (unscreened)		m	100	100	
			EASY412-D...	EASY6...-DC-...	EASY8...-DC-...
Analog inputs					
Number			2	2	4
Potential isolation					
From power supply			No	No	No
From the digital inputs			No	No	No
From the outputs			Yes	Yes	Yes
From the PC interface, memory card NET network, EASY-Link			No	No	No
Input type			DC voltage	DC voltage	DC voltage
Signal range		V DC	0 – 10	0 – 10	0 – 10
Resolution, analog		V	0.01	0.01	0.01
Resolution, digital		V	0.01	0.01	0.01
Resolution, digital		Bit	–	–	10 (value 0 – 1023)
Input impedance		kΩ	11.2	11.2	11.2
Accuracy of actual value					
Two EASY devices		%	± 3	± 3	± 3
Within a single device		%	± 2 (I7, I8) ± 0.12 V	± 2 (I7, I8) ± 0.12 V	± 2 (I7, I8, I11, I12)
Conversion time, analog/digital		ms	Debounce ON: 20; Debounce OFF: every cycle time		Every CPU cycle
Input current		mA	< 1	< 1	< 1
Cable length screened		m	< 30	< 30	< 30

Notes

For more technical data for EASY4... and EASY6... → AWB2528-1508D,
EASY8... → AWB2528-1423D

Technical data

			EASY6..-DC-...	EASY8..-DC-...
Power supply				
Rated operational voltage	U_e	V	24 DC (-15/+20 %)	24 DC (-15/+20 %)
Admissible range		V DC	20.4 – 28.8	20.4 – 28.8
Residual ripple		%	≤ 5	≤ 5
Input current				
at 24 V DC		mA	Normally 140	Normally 80
Voltage dips (IEC/EN 61131-2)		ms	10	10
Heat dissipation at 24 V DC		W	3.4	3.4
			EASY6..-DC-...	EASY8..-DC-...
Digital inputs 24 V DC				
Number			12 (on basic unit)	12
Inputs can be used as analog inputs			I7, I8	I7, I8, I11, I12
Status indication			LCD display (if provided)	LCD display (if provided)
Potential isolation				
From power supply			No	No
Between digital inputs			No	No
From the outputs			Yes	Yes
From the PC interface, memory card NET network, EASY-Link			–	Yes
Rated operating voltage				
Rated operational voltage	U_e	V DC	24	24
On 0 signal	U_e	V DC	< 5.0 (I1 – I12, R1 – R12)	< 5.0 (I1 – I6, I9 – I10), < 8 (I7, I8, I11, I12)
On 1 signal	U_e	V DC	> 15.0 (I1 – I6, I9 – I12, R1 – R12), > 8.0 (I7, I8)	> 15.0 (I1 – I6, I9 – I10), > 8.0 (I7, I8, I11, I12)
Input current on 1 signal				
R1 to R12		mA	3.3 (at 24 V DC)	–
I1 to I6		mA	3.3 (at 24 V DC)	3.3 (at 24 V DC)
I7, I8		mA	2.2 (at 24 V DC)	2.2 (at 24 V DC)
I9, I10		mA	3.3 (at 24 V DC)	3.3 (at 24 V DC)
I11, I12		mA	3.3 (at 24 V DC)	2.2 (at 24 V DC)
Delay time from 0 to 1				
Debounce ON		ms	20	20
Debounce OFF		ms	Normally 0.25 (I1 – I6, I9 – I12)	Normally 0.1 (I1 – I4), normally 0.25 (I5 – I12)
Delay time from 1 to 0				
Debounce ON		ms	20	20
Debounce OFF		ms	Normally 0.4 (I1 – I6, I9 – I12), normally 0.2 (I7, I8)	Normally 0.1 (I1 – I4), normally 0.4 (I5, I6, I9, I12), normally 0.2 (I7, I8, I11, I12)
Cable length (unscreened)		m	100	100
Frequency counter				
Counter frequency		kHz	–	< 5
Pulse shape			–	Square
Pulse pause ratio			–	1:1
Incremental counter				
Counter frequency		kHz	–	< 3
Pulse shape			–	Square
Counter inputs I1 and I2, I3 and I4			–	2
Signal offset			–	90°
Pulse pause ratio			–	1:1
High-speed counter inputs, I1 to I4				
Number			–	4
Cable length, screened		m	–	< 20
High-speed up/down counter				
Counter frequency		kHz	–	< 5
Pulse shape			–	Square
Pulse pause ratio			–	1:1

Notes

For more technical data for EASY4... and EASY6... → AWB2528-1508D,
EASY8... → AWB2528-1423D

Technical data

			EASY412-...-R...	EASY202-RE
Relay outputs				
Number			4	2
Outputs in groups of			1	2
Parallel switching of outputs for increased output			Not permissible	Not permissible
Protection of an output relay			Miniature circuit-breaker B16 or fuse 8 A (slow)	
Potential isolation of the power supply, inputs				
Potential isolation			Yes	Yes
Safe isolation		V AC	300	300
Basic insulation		V AC	600	600
Lifespan, mechanical	Operations	$\times 10^6$	10	10
Contacts				
Conventional thermal current (10 A UL)		A	8	8
Recommended for load: 12 V AC/DC		mA	> 500	> 500
Short-circuit-proof $\cos \varphi = 1$, characteristic B16 at 600 A		A	16	16
Short-circuit-proof $\cos \varphi = 0.5$ to 0.7, characteristic B16 at 900 A		A	16	16
Rated impulse withstand voltage U_{imp} of contact coil		kV	6	6
Rated operational voltage	U_e	V AC	250	250
Rated insulation voltage	U_i	V AC	250	250
Safe isolation to EN 50178 between coil and contact		V AC	300	300
Safe isolation to EN 50178 between two contacts		V AC	300	300
Making capacity				
AC-15, 250 V AC, 3 A (600 Ops./h)	Operations		300000	300000
DC-13 L/R ≤ 150 ms 24 V DC, 1 A (500 Ops./h)	Operations		200000	200000
Breaking capacity				
AC-15, 250 V AC, 3 A (600 Ops./h)	Operations		300000	300000
DC-13 L/R ≤ 150 ms 24 V DC, 1 A (500 Ops./h)	Operations		200000	200000
Filament bulb load				
1000 W at 230/240 V AC	Operations		25000	25000
500 W at 115/120 V AC	Operations		25000	25000
Fluorescent lamp load				
Fluorescent lamp load 10×58 W at 230/240 V AC				
With upstream electrical device	Operations		25000	25000
Uncompensated	Operations		25000	25000
Fluorescent lamp load 1×58 W at 230/240 V AC, conventional, compensated	Operations		25000	25000
Switching frequency				
Mechanical operations		$\times 10^6$	10	10
Switching frequency		Hz	10	10
Resistive load/lamp load		Hz	2	2
Inductive load		Hz	0.5	0.5
UL/CSA				
Uninterrupted current at 240 V AC		A	10	10
Uninterrupted current at 24 V DC		A	8	8
AC				
Control Circuit Rating Codes (utilization category)				
Max. rated operational voltage		V AC	300	300
Max. thermal uninterrupted current $\cos \varphi = 1$ at B 300		A	5	5
Max. make/break capacity $\cos \varphi \neq 1$ at B 300		VA	3600 / 360	3600 / 360
DC				
Control Circuit Rating Codes (utilization category)				
Max. rated operational voltage		V DC	300	300
Max. thermal uninterrupted current at R 300		A	1	1
Max. make/break capacity at R 300		VA	28 / 28	28 / 28

Notes

For more technical data for EASY4... and EASY6... → AWB2528-1508D, EASY8... → AWB2528-1423D

Technical data

			EASY618/619-...-R...	EASY8...-...-R...
Relay outputs				
Number			6	6
Outputs in groups of			1	1
Parallel switching of outputs for increased output			Not permissible	Not permissible
Protection of an output relay			Miniature circuit-breaker B16 or fuse 8 A (slow)	
Potential isolation of the power supply, inputs				
Potential isolation			–	Yes
From the PC interface, memory card NET network, EASY-Link			No	–
Safe isolation		V AC	300	300
Basic insulation		V AC	600	600
Lifespan, mechanical	Operations	$\times 10^6$	10	10
Contacts				
Conventional thermal current (10 A UL)		A	8	8
Recommended for load: 12 V AC/DC		mA	> 500	> 500
Short-circuit-proof $\cos \varphi = 1$, characteristic B16 at 600 A		A	16	16
Short-circuit-proof $\cos \varphi = 0.5$ to 0.7, characteristic B16 at 900 A		A	16	16
Rated impulse withstand voltage U_{imp} of contact coil		kV	6	6
Rated operational voltage	U_e	V AC	250	250
Rated insulation voltage	U_i	V AC	250	250
Safe isolation to EN 50178 between coil and contact		V AC	300	300
Safe isolation to EN 50178 between two contacts		V AC	300	300
Making capacity				
AC-15, 250 V AC, 3 A (600 Ops./h)	Operations		300000	300000
DC-13 L/R ≤ 150 ms 24 V DC, 1 A (500 Ops./h)	Operations		200000	200000
Breaking capacity				
AC-15, 250 V AC, 3 A (600 Ops./h)	Operations		300000	300000
DC-13 L/R ≤ 150 ms 24 V DC, 1 A (500 Ops./h)	Operations		200000	200000
Filament bulb load				
1000 W at 230/240 V AC	Operations		25000	25000
500 W at 115/120 V AC	Operations		25000	25000
Fluorescent lamp load				
Fluorescent lamp load 10×58 W at 230/240 V AC				
With upstream electrical device	Operations		25000	25000
Uncompensated	Operations		25000	25000
Fluorescent lamp load 1×58 W at 230/240 V AC, conventional, compensated	Operations		25000	25000
Switching frequency				
Mechanical operations		$\times 10^6$	10	10
Switching frequency		Hz	10	10
Resistive load/lamp load		Hz	2	2
Inductive load		Hz	0.5	0.5
UL/CSA				
Uninterrupted current at 240 V AC		A	10	10
Uninterrupted current at 24 V DC		A	8	8
AC				
Control Circuit Rating Codes (utilization category)			B 300 Light Pilot Duty	B 300 Light Pilot Duty
Max. rated operational voltage		V AC	300	300
Max. thermal uninterrupted current $\cos \varphi = 1$ at B 300		A	5	5
Max. make/break capacity $\cos \varphi \neq 1$ at B 300		VA	3600 / 360	3600 / 360
DC				
Control Circuit Rating Codes (utilization category)			R 300 Light Pilot Duty	R 300 Light Pilot Duty
Max. rated operational voltage		V DC	300	300
Max. thermal uninterrupted current at R 300		A	1	1
Max. make/break capacity at R 300		VA	28 / 28	28 / 28

Notes

For more technical data for EASY4... and EASY6... → AWB2528-1508D, EASY8... → AWB2528-1423D

Technical data

			EASY412-DC-T...	EASY6...-DC-T...
Transistor outputs				
Number			4	8
Rated operational voltage				
Rated operational voltage	U_e	V DC	24	24
Admissible range	U_e	V DC	20.4 – 28.8	20.4 – 28.8
Residual ripple		%	≤ 5	≤ 5
Supply current				
On 0 signal	Normally max.	mA	9 – 16	18 – 32
On 1 signal	Normally max.	mA	12 – 22	22 – 44
Protection against polarity reversal				
Potential isolation of the power supply, inputs				
Potential isolation				
–				
Rated operational current on 1 signal DC	I_e	A	max. 0.5	max. 0.5
Lamp load without R_v		W	5	5
Residual current on 0 signal per channel		mA	< 1	< 1
Max. output voltage				
On 0 signal with external load < 10 MΩ		V	2.5	2.5
On 1 signal with $I_e = 0.5$ A		V	$U = U_e - 1$ V	$U = U_e - 1$ V
Short-circuit protection				
Yes (evaluation with diagnostics input I16, I15; R15, R16)				
Short-circuit tripping current for $R_a \leq 10$ mΩ		A	$0.7 \leq I_e \leq 2$	$0.7 \leq I_e \leq 2$
Total short-circuit current		A	8	16
Peak short-circuit current		A	16	32
Thermal cutout				
Yes				
Max. operating frequency with constant resistive load $R_L < 100$ kΩ (depending on number of active channels and their load)		Ops./h	40000	40000
Parallel connection of outputs				
With resistive load, inductive load with external suppressor circuit, combination within a group			Group 1: Q1 to Q4	Group 1: Q1 to Q4, S1 to S4 Group 2: Q5 to Q8, S5 to S8
Number of outputs	max.		4	4
Total max. current		A	2	2
Output status indication				
			LCD display (if provided)	LCD display (if provided)

Notes

For more technical data for EASY4... and EASY6... → AWB2528-1508D

Technical data

				EASY8..-D.-T..
Transistor outputs				
Number				8
Rated operational voltage				
Rated operational voltage	U_e	V DC		24
Admissible range	U_e	V DC		20.4 – 28.8
Residual ripple		%		≤ 5
Supply current				
On 0 signal	Normally / max.	mA		18 – 32
On 1 signal	Normally / max.	mA		24 – 44
Protection against polarity reversal				
Yes (Attention: A short-circuit will occur if voltage is applied to the outputs on account of reverse polarity.)				
Potential isolation of the power supply, inputs				
Potential isolation				
From the PC interface, memory card NET network, EASY-Link				
Yes				
Yes				
Rated operational current on 1 signal DC	I_e	A		max. 0.5
Lamp load without R_v		W		3 (Q1 – Q4) 5 (Q5 – Q8)
Residual current on 0 signal per channel		mA		< 0.1
Max. output voltage				
On 0 signal with external load < 10 M Ω		V		2.5
On 1 signal with $I_e = 0.5$ A		V		$U = U_e - 1$ V
Short-circuit protection				
Yes, electronic (Q1 – Q4), thermal (Q5 – Q8), (evaluation implemented with the diagnostics input I16, I15)				
Short-circuit tripping current for $R_a \leq 10$ m Ω		A		$0.7 \leq I_e \leq 2$
Total short-circuit current		A		16
Peak short-circuit current		A		32
Thermal cutout				
Yes				
Max. operating frequency with constant resistive load $R_L < 100$ k Ω (depending on number of active channels and their load)		Ops./h		40000
Parallel connection of outputs				
With resistive load, inductive load with external suppressor circuit, combination within a group				
Group 1: Q1 to Q4 Group 2: Q5 to Q8				
Number of outputs	max.			4
Total max. current		A		2
Output status indication				
LCD display (if provided)				
Inductive load				
Without external suppressor circuit ¹⁾				
$T_{0.95} = 1$ ms, $R = 48$ Ω , $L = 16$ mH				
Utilization factor		g		0.25
Duty factor		% DF		100
Max. switching frequency $f = 0.5$ Hz (max. DF = 50 %)		Operations		1500
DC13, $T_{0.95} = 72$ ms, $R = 48$ Ω , $L = 1.15$ H				
Utilization factor		g		0.25
Duty factor		% DF		100
Max. switching frequency $f = 0.5$ Hz (max. DF = 50 %)		Operations		1500
$T_{0.95} = 15$ ms, $R = 48$ Ω , $L = 0.24$ H				
Utilization factor		g		0.25
Duty factor		% DF		100
Max. switching frequency $f = 0.5$ Hz (max. DF = 50 %)		Operations		1500
With external suppressor circuit				
Utilization factor		g		1
Duty factor		% DF		100
Max. switching frequency, max. duty factor		Operations		Depending on the suppressor circuit

Notes

¹⁾ $T_{0.95}$ = time in ms, until 95 % of steady-state current is achieved.

$T_{0.95} \approx 3 \times T_{0.65} = 3 \times L/R$

For more detailed technical data for EASY8... → AWB2528-1423GB

Technical data

			EASY8...-...-...
NET network			
Stations	Number		max. 8
Data transfer rate/distance			1000 Kbit/s, 6 m 500 Kbit/s, 25 m 250 Kbit/s, 60 m 125 Kbit/s, 125 m 50 Kbit/s, 300 m 20 Kbit/s, 700 m 10 Kbit/s, 1000 m
Potential isolation			
From power supply			Yes
From the inputs			Yes
From the outputs			Yes
From the PC interface, memory card NET network, EASY-Link			Yes
Bus termination (first and last station)			Yes
Connection technique			RJ45, 8-pole
Analog outputs			
Number			1
Potential isolation			
From power supply			No
From the digital inputs			No
From the digital outputs			Yes
From the PC interface, memory card NET network, EASY-Link			Yes
Output type			DC voltage
Signal range	V DC		0 – 10
Max. output current	A		0.01
Load resistance			1 kΩ
Overload and short-circuit protection			Yes
Resolution, analog	V DC		0.01
Resolution, digital	Bit		10, (value: 0 – 1023)
Recovery time	μs		100
Accuracy			
-25 °C – 55 °C	%		2
25 °C	%		1
Conversion time, analog/digital	ms		Every CPU cycle

Approvals

Currently UL/CSA approved, others in preparation	EASY412-DC-R EASY412-DC-RC EASY412-DC-RCX EASY412-DC-TC EASY412-DC-TCX EASY412-DA-RC EASY412-AC-R EASY412-AC-RC EASY412-AC-RCX	EASY621-DC-TC EASY621-DC-TCX EASY619-DC-RC EASY619-DC-RCX EASY619-AC-RC EASY619-AC-RCX EASY620-DC-TE EASY618-AC-RE EASY618-DC-RE	EASY819-AC-RC EASY819-AC-RCX EASY819-DC-RC EASY819-DC-RCX EASY820-DC-RC EASY820-DC-RCX EASY821-DC-TC EASY821-DC-TCX EASY822-DC-TC EASY822-DC-TCX	EASY819-AC-RC EASY819-AC-RCX EASY819-DC-RC EASY819-DC-RCX EASY820-DC-RC EASY820-DC-RCX EASY821-DC-TC EASY821-DC-TCX
Hazardous Location CSA	EASY412-DC-R EASY412-DC-RC EASY412-DC-RCX EASY412-DC-TC EASY412-DC-TCX EASY412-DA-RC EASY412-AC-R	EASY412-AC-RC EASY412-AC-RCX EASY621-DC-TC EASY621-DC-TCX EASY619-DC-RC EASY619-DC-RCX EASY619-AC-RC	EASY619-AC-RCX EASY620-DC-TE EASY618-AC-RE EASY200-EASY EASY205-ASI EASY400-POW	
RINA, Shipping approvals	EASY618-AC-RE EASY619-AC-RC EASY619-AC-RCX EASY619-DC-RC	EASY619-DC-RCX EASY620-DC-TE EASY621-DC-TC EASY621-DC-TCX		
Vibration test to EN 61 373 rail applications, passed test for railway vehicle equipment	EASY412-DC-RC EASY412-DC-TC	EASY618-DC-RC EASY620-DC-TC		

Notes

Data transfer rate in the NET network: bus lengths of 40 m and over only attainable with cables with additional cross-section and connection adapter.

For more detailed technical data for EASY4... and EASY6... → AWB2528-1304GB
EASY8... → AWB2528-1423GB

Technical data

			EASY205-ASI	EASY204-DP
General				
Standards			EN 55011, EN 55022, IEC/EN 61000-4..., IEC/EN 60068-2-27, EN 50295	EN 55011, EN 55022, IEC/EN 61000-4, IEC/EN 60068-2-27, IEC 61158
Dimensions (W × H × D)		mm	35.5 × 90 × 58 (2 space units)	35.5 × 90 × 58 (2 space units)
Weight		kg	0.12	0.15
Mounting			EN 50022 top-hat rail, 35 mm or screw fixing with ZB4-101-GF1 fixing brackets (accessories)	
Terminal capacities				
Solid		mm ²	0.2 / 4 (AWG 22 – 12)	0.2 / 4 (AWG 22 – 12)
Flexible with ferrule		mm ²	0.2 / 2.5 (AWG 22 – 12)	0.2 / 4 (AWG 22 – 12)
Standard screwdriver		mm	3.5 × 0.8	3.5 × 0.8
max. tightening torque		Nm	0.6	0.6
Climatic environmental conditions				
Operating ambient temperature		°C	–25/+55, low temperatures to IEC 60068-2-1, high temperatures to IEC 60068-2-2	
Condensation			Prevent condensation by means of suitable measures	
Storage		°C	–40 – 70	–40 – 70
Relative humidity, non-condensing (IEC/EN 60068-2-30)		%	5 – 95	5 – 95
Air pressure (operation)		hPa	795 – 1080	795 – 1080
Corrosion resistance				
IEC/EN 60068-2-42	4 days SO ₂	cm ³ /m ³	10	10
IEC/EN 60068-2-43	4 days H ₂ S	cm ³ /m ³	1	1
Ambient conditions, mechanical				
Pollution degree			2	2
Degree of protection (IEC/EN 60529)			IP20	IP20
Vibrations (IEC/EN 60068-2-6)				
Constant amplitude 0.15 mm		Hz	10 – 57	10 – 57
Constant acceleration, 2 g		Hz	57 – 150	57 – 150
Mechanical shock resistance (IEC/EN 60068-2-27) semi-sinusoidal 15 g/11 ms		Impacts	18	18
Drop to IEC/EN 60068-2-31	Drop height	mm	50	50
Free fall, packaged (IEC/EN 60068-2-32)		m	1	1
Mounting position			horizontal, vertical	horizontal, vertical
Electromagnetic compatibility (EMC)				
Electrostatic discharge (IEC/EN 61000-4-2, Level 3, ESD)				
Air discharge		kV	8	8
Contact discharge		kV	6	6
Electromagnetic fields (IEC/EN 61000-4-3, RFI)		V/m	10	10
Radio interference suppression (EN 55011)			EN 55011 Class B, EN 55022 Class B	EN 55011 Class A, EN 55022 Class A
Burst pulses (IEC/EN 61000-4-4, level 3)				
AS-Interface cables		kV	2	–
Supply cables		kV	–	2
Signal lines		kV	–	2
High-energy pulses (surge) (IEC/EN 61000-4-5, level 2)		kV	–	0.5 (supply cables, symmetrical)
Immunity to line-conducted interference to (IEC/EN 61000-4-6)		V	10	10

Technical data

			EASY205-ASI	EASY204-DP
Insulation resistance				
Clearance in air and creepage distances			EN 50178, UL 508, CSA C22.2, No. 142	EN 50178, UL 508, CSA C22.2, No. 142
Insulation resistance			EN 50178	EN 50178
Power supply				
Rated operational voltage				
Rated operational voltage	U_e	V	26.5 – 31.6	24 (-15/+20 %)
Admissible range		V DC	–	20.4 – 28.8
Total power consumption of the AS-Interface			≤ 30	–
Residual ripple			–	< 5
at 24 V DC			–	Type 200
Voltage dips (IEC/EN 61131-2)			–	10
Heat dissipation at 24 V DC			–	4.8
Protection against polarity reversal				
AS-Interface interface protection against polarity reversal			Yes	–
AS-Interface profile cable			7F (hex)	–
Slave address			031	–
Addressing unit interface			3.5 mm socket	–
Power supply			–	Yes
LED displays				
Supply			Power: green	Power LED (POW): green
LED display			Com Error: red	LED-PROFIBUS-DP (BUS): red
Logic links				
EASY600 contact/coil \leftrightarrow AS-Interface			S1 \rightarrow input 0 S1 \rightarrow input 1 S3 \rightarrow input 2 S4 \rightarrow input 3 R1 \leftarrow output 0 R2 \leftarrow output 1 R3 \leftarrow output 2 R4 \leftarrow output 3 R5 \leftarrow PARAMETER OUTPUT 0 R6 \leftarrow PARAMETER OUTPUT 1 R7 \leftarrow PARAMETER OUTPUT 2 R8 \leftarrow PARAMETER OUTPUT 3	–
PROFIBUS DP				
Connection technique			–	SUB-D 9-pole, socket
Potential isolation			–	Between bus and power supply (simple), between bus and power supply and EASY basic unit (safe isolation)
Function			–	PROFIBUS-DP slave
Interface			–	RS 485
Bus protocol			–	PROFIBUS DP
Baud rates			–	Automatic search up to 12 MBit / s
Bus terminating resistors			–	Can be connected via plug
Bus addresses			–	1 – 126, can be addressed via EASY basic unit with display or via EASY-SOFT
Services				
Cyclical			–	All data R1 – R16, S1 – S8
Acyclical			–	Read / write, time, data, summer/winter time (DST), all parameters of EASY function relays

Technical data

			EASY221-CO	EASY222-DN
General				
Standards			EN 61000-6-1/-2/-3/-4, IEC 60068-2-6, IEC 60068-2-27	
Dimensions (W × H × D)		mm	35.5 × 90 × 58 (2 space units)	35.5 × 90 × 58 (2 space units)
Weight		kg	0.15	0.15
Mounting			EN 50022 top-hat rail, 35 mm or screw fixing with ZB4-101-GF1 fixing brackets (accessories)	
Terminal capacities				
Solid		mm ²	0.2 / 4 (AWG 22 – 12)	0.2 / 4 (AWG 22 – 12)
Flexible with ferrule		mm ²	0.2 / 2.5 (AWG 22 – 12)	0.2 / 2.5 (AWG 22 – 12)
Standard screwdriver		mm	3.5 × 0.8	3.5 × 0.8
max. tightening torque		Nm	0.6	0.6
Climatic environmental conditions				
Operating ambient temperature		°C	–25/+55, low temperatures to IEC 60068-2-1, high temperatures to IEC 60068-2-2	
Condensation			Prevent condensation by means of suitable measures	
Storage		°C	–40 – 70	–40 – 70
Relative humidity, non-condensing (IEC/EN 60068-2-30)		%	5 – 95	5 – 95
Air pressure (operation)		hPa	795 – 1080	795 – 1080
Corrosion resistance				
IEC/EN 60947-2-42	4 days SO ₂	cm ³ /m ³	10	10
IEC/EN 60947-2-43	4 days H ₂ S	cm ³ /m ³	1	1
Ambient conditions, mechanical				
Pollution degree			2	2
Degree of protection (IEC/EN 60529)			IP20	IP20
Vibrations (IEC/EN 60068-2-6)				
Constant amplitude 0.15 mm		Hz	10 – 57	10 – 57
Constant acceleration, 2 g		Hz	57 – 150	57 – 150
Mechanical shock resistance (IEC/EN 60068-2-27)				
semi-sinusoidal 15 g/11 ms		Impacts	18	18
Drop to IEC/EN 60068-2-31	Drop height	mm	50	50
Free fall, packaged (IEC/EN 60068-2-32)		m	1	1
Mounting position			horizontal, vertical	horizontal, vertical
Electromagnetic compatibility (EMC)				
Electrostatic discharge (IEC/EN 61000-4-2, Level 3, ESD)				
Air discharge		kV	8	8
Contact discharge		kV	6	6
Electromagnetic fields (IEC/EN 61000-4-3, RFI)				
		V/m	10	10
Radio interference suppression (EN 55011)				
			EN 55011 Class B, EN 55022 Class B	EN 55011 Class B, EN 55022 Class B
Burst pulses (IEC/EN 61000-4-4, level 3)				
Supply cables		kV	2	2
Signal lines		kV	2	2
High-energy pulses (surge) (IEC/EN 61000-4-5, level 2)		kV	0.5 (supply cables, symmetrical)	0.5 (supply cables, symmetrical)
Immunity to line-conducted interference to (IEC/EN 61000-4-6)		V	10	10

Technical data

				EASY221-CO	EASY222-DN
Insulation resistance					
Clearance in air and creepage distances				EN 50178, UL 508, CSA C22.2, No. 142	EN 50178, UL 508, CSA C22.2, No. 142
Insulation resistance				EN 50178	EN 50178
Power supply					
Rated operational voltage					
Rated operational voltage	U_e	V	24 (-15/+20 %)	24 (-15/+20 %)	
Admissible range		V DC	20.4 – 28.8	20.4 – 28.8	
Residual ripple		%	< 5	< 5	
at 24 V DC		mA	Normally 200	Normally 200	
Voltage dips (IEC/EN 61131-2)		ms	10	10	
Heat dissipation at 24 V DC		W	4.8	4.8	
Protection against polarity reversal					
Power supply		V DC	Yes	Yes	
LED displays					
Supply			RUN LED (RUN): green	Module Status LED (MS): green	
LED display			LED ERROR (ERR): red	LED network status (NS): red/green	
Network					
Connection technique			RJ45	5-pole, pluggable screw terminal	
Potential isolation			Between bus and power supply (simple), between bus and power supply and EASY basic unit (safe isolation)		
Function			CANopen slave	DeviceNet slave	
Interface			CAN	CAN	
Bus protocol			CANopen	DeviceNet	
Baud rates			Automatic search up to 1 MBit / s	Automatic search up to 500 Kbit / s	
Bus terminating resistors			Separate, external bus termination required (120 Ω)	Separate, external bus termination required (120 Ω)	
Bus addresses			1 – 127, can be addressed via EASY basic unit with display or via EASY-SOFT	0 – 63, can be addressed via EASY basic unit with display or via EASY-SOFT	
Services					
Cyclical			All data R1 – R16, S1 – S8	All data R1 – R16, S1 – S8	
Acyclical			Read / write, time, data, summer/winter time (DST), all parameters of EASY function relays	Read / write, time, data, summer/winter time (DST), all parameters of EASY function relays	

Technical data

			EASY200-POW	EASY400-POW
General				
Standards			EN 55011, EN 55022, IEC/EN 61000-4..., IEC/EN 60068-2-27	
Dimensions (W × H × D)		mm	35.5 × 90 × 58 (2 space units)	71.5 × 90 × 58 (4 space units)
Weight		kg	0.1	0.25
Mounting			EN 50022 top-hat rail, 35 mm or screw fixing with ZB4-101-GF1 fixing brackets (accessories)	
Terminal capacities				
Solid		mm ²	0.2 / 4 (AWG 22 – 12)	0.2 / 4 (AWG 22 – 12)
Flexible with ferrule		mm ²	0.2 / 2.5 (AWG 22 – 12)	0.2 / 2.5 (AWG 22 – 12)
Standard screwdriver		mm	3.5 × 0.8	3.5 × 0.8
max. tightening torque		Nm	0.6	0.6
Climatic environmental conditions				
Operating ambient temperature		°C	–25/+55, low temperatures to IEC 60068-2-1, high temperatures to IEC 60068-2-2	
Condensation			Prevent condensation by means of suitable measures	
Storage		°C	–40 – 70	–40 – 70
Relative humidity, non-condensing (IEC/EN 60068-2-30)		%	5 – 95	5 – 95
Air pressure (operation)		hPa	795 – 1080	795 – 1080
Corrosion resistance				
IEC/EN 60947-2-42	4 days SO ₂	cm ³ /m ³	10	10
IEC/EN 60947-2-43	4 days H ₂ S	cm ³ /m ³	1	1
Max. installation altitude above sea level, observe derating with higher altitudes		m	2000	2000
Ambient conditions, mechanical				
Pollution degree			2	2
Degree of protection (IEC/EN 60529, EN 50178)			IP20	IP20
Vibrations (IEC/EN 60068-2-6)				
Constant amplitude 0.15 mm		Hz	10 – 57	10 – 57
Constant acceleration, 2 g		Hz	57 – 150	57 – 150
Mechanical shock resistance (IEC/EN 60068-2-27) semi-sinusoidal 15 g/11 ms		Impacts	18	18
Drop to IEC/EN 60068-2-31	Drop height	mm	50	50
Free fall, packaged (IEC/EN 60068-2-32)		m	1	1
Mounting position			horizontal, vertical	horizontal, vertical
Electromagnetic compatibility (EMC)				
Electrostatic discharge (IEC/EN 61000-4-2, Level 3, ESD)				
Air discharge		kV	8	8
Contact discharge		kV	6	6
Electromagnetic fields (IEC/EN 61000-4-3, RFI)		V/m	10	10
Radio interference suppression (EN 55011)			EN 50011 Class B; EN 50022 Class B, EN 50081-2 Class B	
Burst pulses (IEC/EN 61000-4-4, level 3)		kV	2	2
High-energy pulses (surge) (IEC/EN 61000-4-5)		kV	2 (supply cables, symmetrical)	2 (supply cables, symmetrical, EASY...AC)
High-energy pulses (surge) (IEC/EN 61000-4-5, level 2), 24 V		kV	0.5 (output cables, symmetrical)	0.5 (output cables, symmetrical)
Immunity to line-conducted interference to (IEC/EN 61000-4-6)		V	10	10
Surge voltage (EN 50178), 24 V		kV	6	6
Insulation resistance				
Clearance in air and creepage distances			EN 50 178	EN 50 178
Insulation resistance			EN 50 178	EN 50178
Protection class U_{out} to U_{in}			Class II to IEC 60536	Class II to IEC 60536
Potential isolation primary/secondary			Yes, SELV (VDE 0100 T410; IEC 60364-4-41, HD 384.4.41 S2) EN 60950	
Input voltage				
Rated input voltage		V AC	100/120/230/240 (–15/+10 %)	100/120/230/240 (–15/+10 %)
Bemessungseingangsspannung		V AC	1.5 slow	1.5 slow
Voltage range		V AC	85 – 264	85 – 264
Frequency range		Hz	47 – 63	47 – 63
Power failure bridging 115/230 V		ms	10/> 20	10/> 20
Fuse 115/230 V		A	1.5 slow	2/1 slow
Protective switches AC			FAZ-C1 or FAZ-B6	FAZ-C2 or FAZ-B6

Technical data

		EASY200-POW	EASY400-POW
Rating data			
Efficiency	%	> 81	> 87
Power consumption	W	Normally 7	Normally 35
Power loss	W	Normally 1	Normally 5
Input current			
Input current rated value 115/230 V AC	A	Approx. 0.17/0.05	Approx. 0.3/0.15
Inrush current at 25 °C 230 V	A	< 5	< 5
Output voltage			
12 V DC (reference voltage)			
Rated value	V DC	12	–
Tolerance	%	± 4	–
Switching peaks	mV _{SS}	< 7	–
Effect of input voltage	%	± 1	–
Effect with 25 – 100 % load change	%	± 1	–
24 V DC			
Rated value	V DC	24	24
Tolerance	%	± 3	± 5
Switching peaks 115/230	mV _{SS}	< 50/30	< 5
Effect of input voltage	%	± 1	± 1
Effect with 25 – 100 % load change	%	± 1	± 2
Output current			
12 V DC (reference voltage)			
Output current	mA	0 – 20	–
Effectiveness of current limitation	mA	20	–
Reduction of output voltage after current limitation	V	< 12	–
Overload proof		Yes, by current limitation proof against sustained short-circuits	–
Proof against sustained short circuit		Yes	–
24 V DC			
Output current	A	0 – 0.25	0 – 1.25
Effectiveness of current limitation	A	> 0.3	> 1.25
Reduction of output voltage after current limitation	V	–	< 18
Overload proof		Yes, by current limitation	Yes, by current limitation
Proof against sustained short circuit		Yes, hiccup-mode	Yes, hiccup-mode approx. 10 Hz
Special load conditions			
Lamp load, cold, 24 V DC	W	2	10
Base load present	W	2	5
Behaviour on emergency-stop in 24 V circuit, disconnection with contactor (contactor load, no damage)	W	6	30
Displays			
Indication of output voltage (LED, continuous green light = OK)	V DC	24	24

Technical data

				EASY256-HCI
General				
Standards				EN 55011, EN 55022, IEC/EN 61000-4..., IEC/EN 60068-2-27
Dimensions (W × H × D)		mm		35.5 × 90 × 58 (2 space units)
Mounting				EN 50022 top-hat rail, 35 mm or screw fixing with ZB4-101-GF1 fixing brackets (accessories)
Channels		Qty.		6
Voltage range at U_e				0 – 264
Higher current 115/230 V AC		mA		4/6
Extension of the switch off delay per EASY input ("1" to "0") 50/60 Hz		ms		40/37
Cable length		m		100
Parallel switching of outputs for increased output				Multiple possibilities (the switch-off delay extends accordingly with the respective number of parallel channels)
Type or resistance				Capitative
Terminal capacities				
Solid		mm ²		0.2 / 4 (AWG 22 – 12)
Flexible with ferrule		mm ²		0.2 / 2.5 (AWG 22 – 12)
Standard screwdriver		mm		3.5 × 0.8
max. tightening torque		Nm		0.6
Climatic environmental conditions				
Operating ambient temperature		°C		–25/+55, low temperatures to IEC 60068-2-1, high temperatures to IEC 60068-2-2
Condensation				Prevent condensation by means of suitable measures
LCD display (clearly legible)		°C		0 – 55
Storage		°C		–40 – 70
Relative humidity, non-condensing (IEC/EN 60068-2-30)		%		5 – 95
Air pressure (operation)		hPa		795 – 1080
Corrosion resistance				
IEC/EN 60947-2-42	4 days SO ₂	cm ³ /m ³		10
IEC/EN 60947-2-43	4 days H ₂ S	cm ³ /m ³		1
Ambient conditions, mechanical				
Pollution degree				2
Degree of protection (IEC/EN 60529)				IP20
Vibrations (IEC/EN 60068-2-6)				
Constant amplitude 0.15 mm		Hz		10 – 57
Constant acceleration, 2 g		Hz		57 – 150
Mechanical shock resistance (IEC/EN 60068-2-27) semi-sinusoidal 15 g/11 ms		Impacts		18
Drop to IEC/EN 60068-2-31	Drop height	mm		50
Free fall, packaged (IEC/EN 60068-2-32)		m		1
Mounting position				horizontal, vertical
Electromagnetic compatibility (EMC)				
Electrostatic discharge (IEC/EN 61000-4-2, Level 3, ESD)				
Air discharge		kV		8
Contact discharge		kV		6
Electromagnetic fields (IEC/EN 61000-4-3, RFI)		V/m		10
Radio interference suppression (EN 55011)				EN 55011 Class B, EN 55022 Class B
High-energy pulses (surge) (IEC/EN 61000-4-5)		kV		2 (supply cables, symmetrical, EASY...AC)
Immunity to line-conducted interference to (IEC/EN 61000-4-6)		V		10
Insulation resistance				
Clearance in air and creepage distances				EN 50178, UL 508, CSA C22.2, No. 142
Insulation resistance				EN 50178

Technical data

			MFD-80..	MFD-CP8..
General				
Standards			EN 61000-6-1/-2/-3/-4, IEC 60068-2-6, IEC 60068-2-27	
Dimensions (W × H × D)		mm	86.5 × 86.5 × 21.5 (with actuators) 86.5 × 86.5 × 20 (without actuators)	107.5 × 90 × 30
Weight		kg	0.13	0.145
Mounting			2 × 22.5 mm, display is fastened with two fastening rings	Fitted on the fixing shaft of the display or on top-hat rail to DIN 50022, 35 mm (without display) or by means of brackets (without display)
Terminal capacities				
Solid		mm ²	–	0.75 / 2.5 (AWG 22 – 12)
Flexible with ferrule		mm ²	–	0.5 / 1.5 (AWG 22 – 12)
Standard screwdriver		mm	–	3.5 × 0.6
Climatic environmental conditions				
Operating ambient temperature		°C	–25/+55, low temperatures to IEC 60068-2-1, high temperatures to IEC 60068-2-2	
Condensation			Prevent condensation by means of suitable measures	
LCD display (clearly legible)		°C	0 – 50	–
Storage		°C	–40 – 70	–40 – 70
Relative humidity, non-condensing (IEC/EN 60068-2-30)		%	5 – 95	5 – 95
Air pressure (operation)		hPa	795 – 1080	795 – 1080
Ambient conditions, mechanical				
Pollution degree			3	2
Degree of protection (IEC/EN 60529)			IP65	IP20
Vibrations (IEC/EN 60068-2-6)				
Constant amplitude 0.15 mm		Hz	10 – 57	10 – 57
Constant acceleration, 2 g		Hz	57 – 150	57 – 150
Mechanical shock resistance (IEC/EN 60068-2-27) semi-sinusoidal 15 g/11 ms		Impacts	18	18
Drop to IEC/EN 60068-2-31	Drop height	mm	50	50
Free fall, packaged (IEC/EN 60068-2-32)		m	1	1
Mounting position			horizontal, vertical	horizontal, vertical
Electromagnetic compatibility (EMC)				
Electrostatic discharge (IEC/EN 61000-4-2, Level 3, ESD)				
Air discharge		kV	8	8
Contact discharge		kV	6	6
Electromagnetic fields (IEC/EN 61000-4-3, RFI)		V/m	10	10
Radio interference suppression (EN 55011)			EN 55011 Class B, EN 55022 Class B	
Burst pulses (IEC/EN 61000-4-4, level 3)				
Supply cables		kV	2	2
Signal lines		kV	2	2
High-energy pulses (surge) (IEC/EN 61000-4-5)		kV	2 (supply cables, symmetrical)	
High-energy pulses (surge) (IEC/EN 61000-4-5, level 2)		kV	0.5 (supply cables, symmetrical)	
Immunity to line-conducted interference to (IEC/EN 61000-4-6)		V	10	10
Insulation resistance				
Clearance in air and creepage distances			EN 50178, UL 508, CSA C22.2, No. 142	
Insulation resistance			EN 50178	EN 50178
Backup/accuracy of the real-time clock				
Back-up of the real-time clock			–	→ Page 5
Accuracy of the real-time clock			–	Normally ±5 s/day (±0.5 h / year)
Repetition accuracy of timing relays				
Accuracy of timing relays (of values)		%	–	± 0.02
Resolution				
Range "S"		ms	–	5
Range "M:S"		s	–	1
Range "H:M"		min	–	1
Retentive memory				
Write cycles of the retentive memory			–	≥ 10 ¹⁰ (read/write cycles)

Technical data

			MFD-R..	MFD-T...
General				
Standards			EN 61000-6-1/-2/-3/-4, IEC 60068-2-6, IEC 60068-2-27	EN 61000-6-1/-2/-3/-4, IEC 60068-2-6, IEC 60068-2-27
Dimensions (W × H × D)		mm	89 × 90 × 44	89 × 90 × 25 (installed)
Weight		kg	0.15	0.14
Mounting			Fitted into the power supply unit.	Fitted into the power supply unit.
Terminal capacities				
Solid		mm ²	0.75 / 2.5 (AWG 22 – 12)	0.75 / 2.5 (AWG 22 – 12)
Flexible with ferrule		mm ²	0.5 / 1.5 (AWG 22 – 12)	0.5 / 1.5 (AWG 22 – 12)
Standard screwdriver		mm	3.5 × 0.6	3.5 × 0.6
Climatic environmental conditions				
Operating ambient temperature		°C	-25/+55, low temperatures to IEC 60068-2-1, high temperatures to IEC 60068-2-2	-25/+55, low temperatures to IEC 60068-2-1, high temperatures to IEC 60068-2-2
Condensation			Prevent condensation by means of suitable measures	
Storage		°C	-40 – 70	-40 – 70
Relative humidity, non-condensing (IEC/EN 60068-2-30)		%	5 – 95	5 – 95
Air pressure (operation)		hPa	795 – 1080	795 – 1080
Ambient conditions, mechanical				
Pollution degree			2	2
Degree of protection (IEC/EN 60529)			IP20	IP20
Vibrations (IEC/EN 60068-2-6)				
Constant amplitude 0.15 mm		Hz	10 – 57	10 – 57
Constant acceleration 2 g		Hz	57 – 150	57 – 150
Mechanical shock resistance (IEC/EN 60068-2-27) semi-sinusoidal 15 g/11 ms		Impacts	18	18
Drop to IEC/EN 60068-2-31	Drop height	mm	50	50
Free fall, packaged (IEC/EN 60068-2-32)		m	1	1
Mounting position			horizontal, vertical	horizontal, vertical
Electromagnetic compatibility (EMC)				
Electrostatic discharge (IEC/EN 61000-4-2, Level 3, ESD)				
Air discharge		kV	8	8
Contact discharge		kV	6	6
Electromagnetic fields (IEC/EN 61000-4-3, RFI)		V/m	10	10
Radio interference suppression (EN 55011)			EN 55011 Class B, EN 55022 Class B	EN 55011 Class B, EN 55022 Class B
Burst pulses (IEC/EN 61000-4-4, level 3)				
Supply cables		kV	2	2
Signal lines		kV	2	2
High-energy pulses (surge) (IEC/EN 61000-4-5)		kV	2 (supply cables, symmetrical)	
High-energy pulses (surge) (IEC/EN 61000-4-5, level 2)		kV	0.5 (supply cables, symmetrical)	
Immunity to line-conducted interference to (IEC/EN 61000-4-6)		V	10	10
Insulation resistance				
Clearance in air and creepage distances			EN 50178, UL 508, CSA C22.2, No. 142	EN 50178, UL 508, CSA C22.2, No. 142
Insulation resistance			EN 50178	EN 50178

Technical data

				MFD-CP8..
Power supply				
Rated operational voltage	U_e	V		24 DC (-15 / +20 %)
Admissible range		V DC		20.4 – 28.8
Residual ripple		%		≤ 5
Input current				
at 24 V DC		mA		Normally 200
Voltage dips (IEC/EN 61131-2)		ms		10
Heat dissipation at 24 V DC		W		3.4
				MFD-T..., MFD-R...
Digital inputs 24 V DC				
Number				12
Inputs can be used as analog inputs				I7, I8, I11, I12
Potential isolation				
From power supply				No
Between digital inputs				No
From the outputs				Yes
From the PC interface, memory card NET network, EASY-Link				Yes
Rated operational voltage	U_e	V DC		24
On 0 signal	U_e	V DC		< 5.0 (I1 – I6, I9 – I10), < 8 (I7, I8, I11, I12)
On 1 signal	U_e	V DC		> 15.0 (I1 – I6, I9 – I10), > 8.0 (I7, I8, I11, I12)
Input current on 1 signal				
I1 to I6		mA		3.3 (at 24 V DC)
I7, I8		mA		2.2 (at 24 V DC)
I9, I10		mA		3.3 (at 24 V DC)
I11, I12		mA		2.2 (at 24 V DC)
Delay time from 0 to 1				
Debounce ON		ms		20
Debounce OFF		ms		Normally 0.1 (I1 – I4), normally 0.25 (I5 – I12)
Delay time from 1 to 0				
Debounce ON		ms		20
Debounce OFF		ms		Normally 0.1 (I1 – I4), normally 0.4 (I5, I6, I9, I10), normally 0.2 (I7, I8, I11, I12)
Cable length (unscreened)		m		100
Frequency counter				
Counter frequency		kHz		< 5
Pulse shape				Square
Pulse pause ratio				1:1
Incremental counter				
Counter frequency		kHz		< 3
Pulse shape				Square
Counter inputs I1 and I2, I3 and I4				2
Signal offset				90°
Pulse pause ratio				1:1
High-speed counter inputs, I1 to I4				
Number				4
Cable length, screened		m		< 20
High-speed up/down counter				
Counter frequency		kHz		< 5
Pulse shape				Square
Pulse pause ratio				1:1

Technical data

			MFD-CP8-NT
NET network			
Stations		Number	max. 8
Data transfer rate/distance			1000 Kbit/s, 6 m 500 Kbit/s, 25 m 250 Kbit/s, 40 m 125 Kbit/s, 125 m 50 Kbit/s, 300 m 20 Kbit/s, 700 m 10 Kbit/s, 1000 m
Potential isolation			
From power supply			Yes
From the inputs			Yes
From the outputs			Yes
From the PC interface, memory card NET network, EASY-Link			Yes
Bus termination (first and last station)			Yes
Connection technique			RJ45, 8-pole
			MFD-T..., MFD-R...
Analog inputs			
Number			4
Potential isolation			
From power supply			No
From the digital inputs			Yes
From the outputs			Yes
From the PC interface, memory card NET network, EASY-Link			Yes
Input type			DC voltage
Signal range		V DC	0 – 10
Resolution, analog		V	0.1
Resolution, digital		V	0.1
Total max. current		Bit	10 (value 0 – 1023)
Input impedance		kΩ	11.2
Accuracy of actual value			
two MFD devices		%	± 3
Within a single device		%	± 2 (I7, I8, I11, I12)
Conversion time, analog/digital		ms	Every CPU cycle
Input current		mA	< 1
Cable length screened		m	< 30

Technical data

			MFD-R..
Relay outputs			
Number			4
Parallel switching of outputs for increased output			Not permissible
Protection of an output relay			Miniature circuit-breaker B16 or fuse 8 A (slow)
Potential isolation			
From power supply			Yes
From the inputs			Yes
Safe isolation		V AC	300
Basic insulation		V AC	600
Lifespan, mechanical	Operations	$\times 10^6$	10
Contacts			
Conventional thermal current (10 A UL)		A	8
Recommended for load: 12 V AC/DC		mA	> 500
Short-circuit-proof $\cos \varphi = 1$, characteristic B16 at 600 A		A	16
Short-circuit-proof $\cos \varphi = 0.5$ to 0.7, characteristic B16 at 900 A		A	16
Rated impulse withstand voltage U_{imp} of contact coil		kV	6
Rated operational voltage	U_e	V AC	250
Rated insulation voltage	U_i	V AC	250
Safe isolation to EN 50178 between coil and contact		V AC	300
Safe isolation to EN 50178 between two contacts		V AC	300
Making capacity			
AC-15, 250 V AC, 3 A (600 Ops./h)	Operations		300000
DC-13 L/R ≤ 150 ms 24 V DC, 1 A (500 Ops./h)	Operations		200000
Breaking capacity			
AC-15, 250 V AC, 3 A (600 Ops./h)	Operations		300000
DC-13 L/R ≤ 150 ms 24 V DC, 1 A (500 Ops./h)	Operations		200000
Filament bulb load			
1000 W at 230/240 V AC	Operations		25000
500 W at 115/120 V AC	Operations		25000
Fluorescent lamp load			
Fluorescent lamp load 10×58 W at 230/240 V AC			
With upstream electrical device	Operations		25000
Uncompensated	Operations		25000
Fluorescent lamp load 1×58 W at 230/240 V AC, conventional, compensated	Operations		25000
Switching frequency			
Mechanical operations		$\times 10^6$	10
Switching frequency		Hz	10
Resistive load/lamp load		Hz	2
Inductive load		Hz	0.5
UL/CSA			
Uninterrupted current at 240 V AC		A	10
Uninterrupted current at 24 V DC		A	8
AC			
Control Circuit Rating Codes (utilization category)			B 300 Light Pilot Duty
Max. rated operational voltage		V AC	300
Max. thermal uninterrupted current at B 300(RefExtrakt)		A	5
Max. make/break capacity at B 300		VA	3600 / 360
DC			
Control Circuit Rating Codes (utilization category)			R 300 Light Pilot Duty
Max. rated operational voltage		V DC	300
Max. thermal uninterrupted current at R 300		A	1
Max. make/break capacity at R 300		VA	28 / 28

Technical data

			MFD-T..
Transistor outputs			
Number			4
Rated operational voltage	U_e	V DC	24
Admissible range			
Permissible range minim.	U_e	V DC	20.4
Permissible range max.	U_e	V DC	28.8
Residual ripple		%	≤ 5
Supply current			
On 0 signal	Normally / max.	mA	18 – 32
On 1 signal	Normally / max.	mA	24 – 44
Protection against polarity reversal			Yes (Caution: A short-circuit will occur if voltage is applied to the outputs on account of reverse polarity).
Potential isolation			
From power supply			Yes
From the PC interface, memory card NET network, EASY-Link			Yes
Rated operational current on 1 signal DC	I_e	A	max. 0.5
Lamp load without R_v		W	5 (Q1 – Q4)
Residual current on 0 signal per channel		mA	< 0.1
Max. output voltage			
On 0 signal with external load < 10 M Ω		V	2.5
On 1 signal with $I_e = 0.5$ A		V	$U = U_e - 1$ V
Short-circuit protection			Thermal (Q1 – Q4), (evaluation with diagnostics input I16)
Short-circuit tripping current for $R_a \leq 10$ m Ω		A	$0.7 \leq I_e \leq 2$
Total short-circuit current		A	8
Peak short-circuit current		A	16
Thermal cutout			Yes
Max. operating frequency with constant resistive load $R_L < 100$ k Ω (depending on number of active channels and their load)			Ops./h 40000
Parallel connection of outputs			
With resistive load, inductive load with external suppressor circuit, combination within a group			Group 1: Q1 to Q4
Number of outputs	max.		4
Total max. current		A	2
Inductive load			
Without external suppressor circuit			
$T_{0.95} = 1$ ms, $R = 48$ Ω , $L = 16$ mH			
Utilization factor		g	0.25
Duty factor		% DF	100
Max. switching frequency $f = 0.5$ Hz (max. DF = 50 %)		Operations	1500
DC13, $T_{0.95} = 72$ ms, $R = 48$ Ω , $L = 1.15$ H			
Utilization factor		g	0.25
Duty factor		% DF	100
Max. switching frequency $f = 0.5$ Hz (max. DF = 50 %)		Operations	1500
$T_{0.95} = 15$ ms, $R = 48$ Ω , $L = 0.24$ H			
Utilization factor		g	0.25
Duty factor		% DF	100
Max. switching frequency $f = 0.5$ Hz (max. DF = 50 %)		Operations	1500
With external suppressor circuit			
Utilization factor		g	1
Duty factor		% DF	100
Max. switching frequency, max. duty factor		Operations	Depending on the suppressor circuit

Technical data

			MFD-TA.. MFD-RA..
Analog outputs			
Number			1
Potential isolation			
From power supply			No
From the digital inputs			No
From the digital outputs			Yes
From the PC interface, memory card NET network, EASY-Link			Yes
Output type			DC voltage
Signal range		V DC	0 – 10
Max. output current		A	0.01
Load resistance			1 k Ω
Overload and short-circuit protection			Yes
Resolution, analog		V DC	0.01
Resolution, digital		Bit	10, (value: 0 – 1023)
Recovery time		μ s	100
Accuracy			
-25 °C – 55 °C		%	2
25°C		%	1
Conversion time, analog/digital		ms	Every CPU cycle

Dimensions

easy control relay

EASY2...

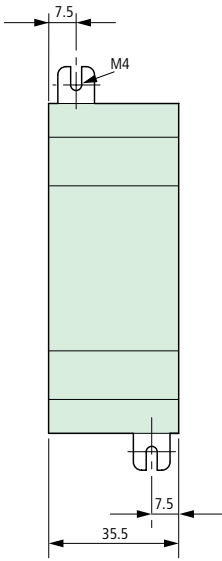

EASY4...

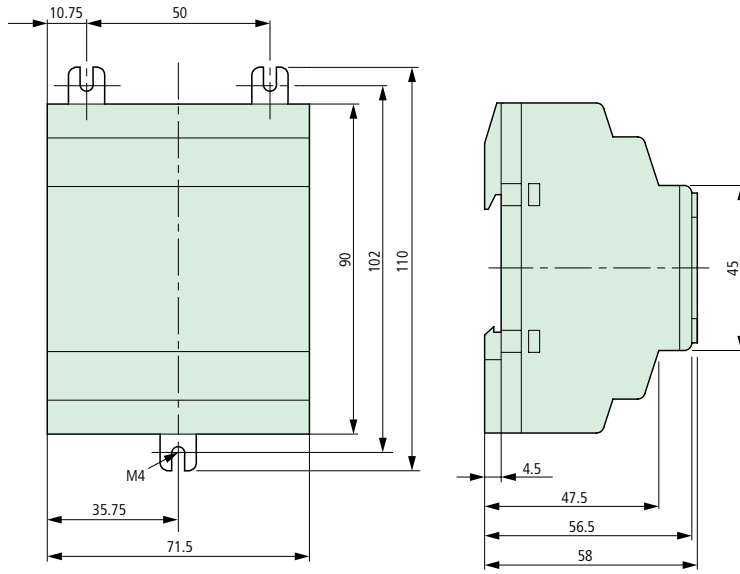

EASY6...

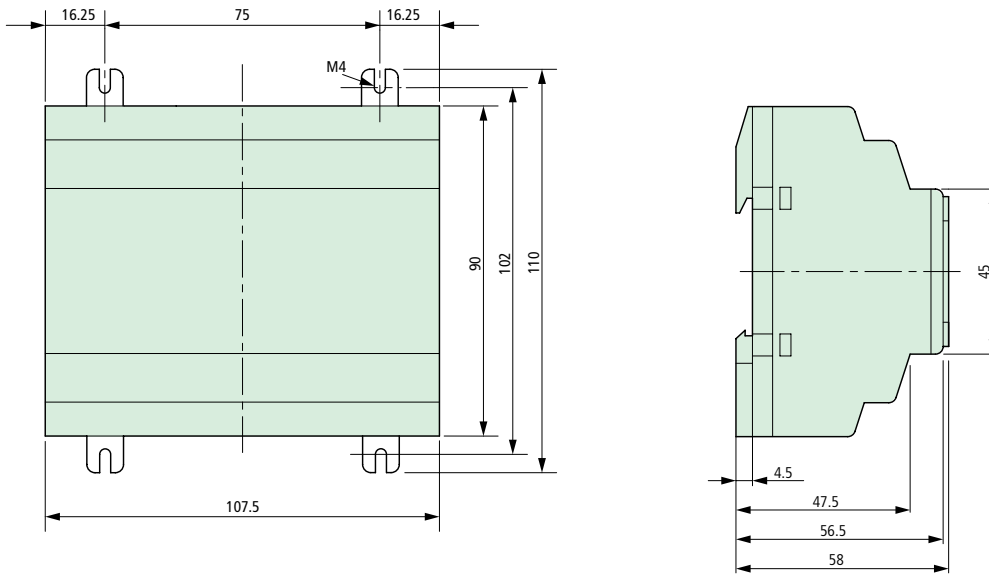

EASY8...

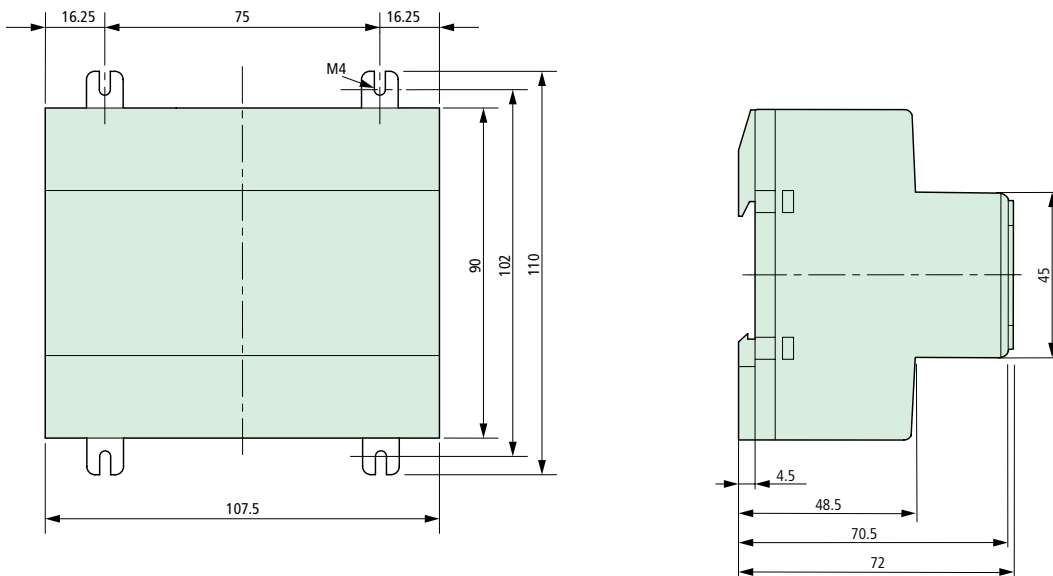

Dimensions

MFD-80...

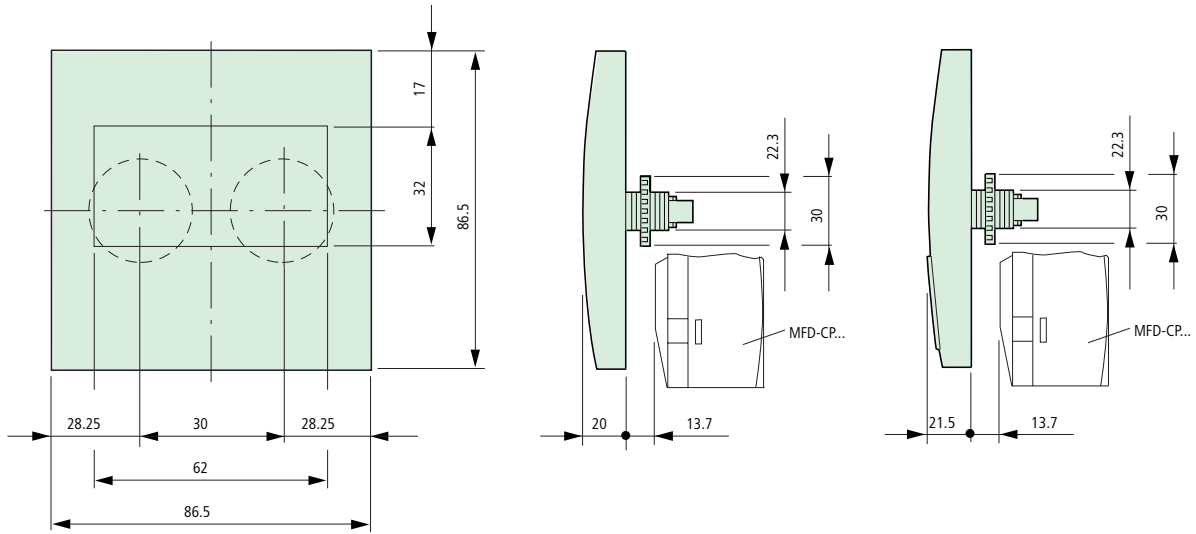

MFD-CP...

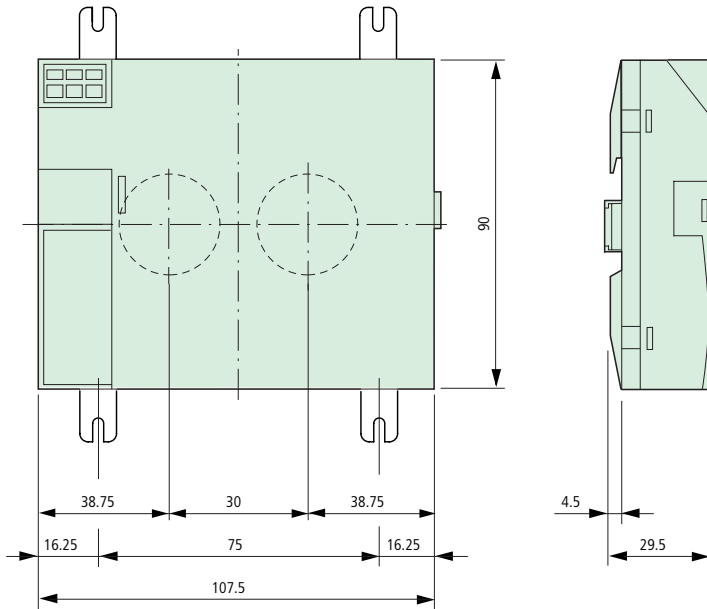

MFD-80... + MFD-CP... + MFD-R.../MFD-T...

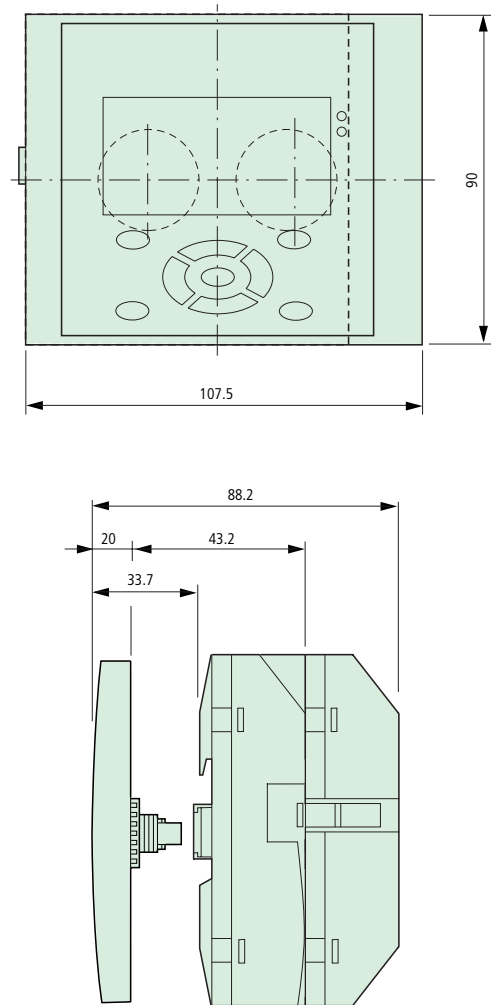

MFD-R..., MFD-T...

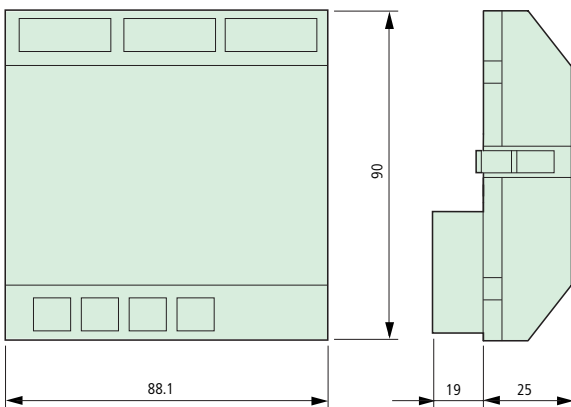

Dimensions

SKF Inspection flap window

SKF-FF4

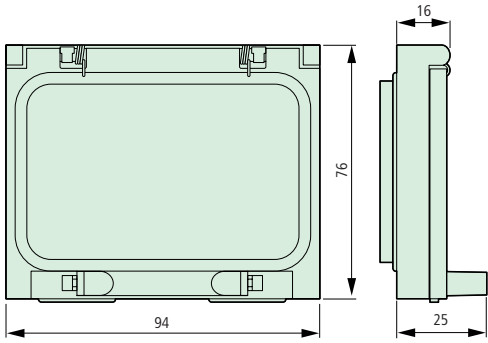

SKF-FF6

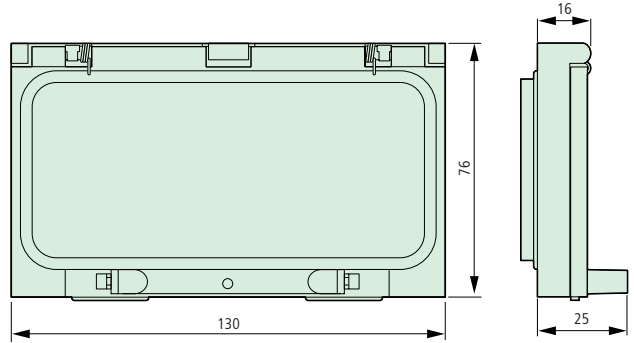

Top-hat rail adapter for inspection flap window

SKF-HA

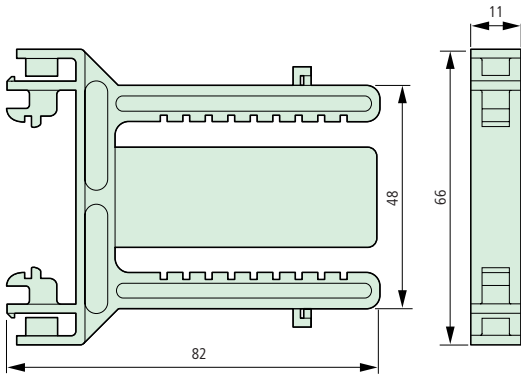

Protective membrane

MFD-XM-80

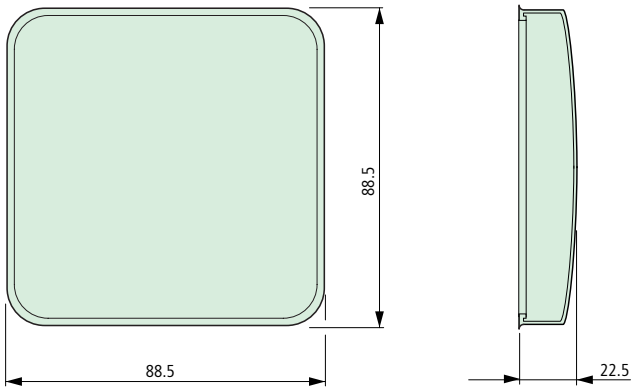

Protective cover, transparent

MFD-XS-80

