

Titan LED Light Engines

Datasheet

Bright.
Compact.
Reliable.

At Lamina we're **changing** the way you think
about **designing** with LEDs.

120 Hancock Lane • Westampton, NJ 08060
609.265.1401 • 800.808.5822

Table of Contents

Introducing Titan Light Engines4

Characteristics

Flux - Lumens, Junction Temperature, $T_j = 25^\circ\text{C}$5

Optical, Whites..... 5

Optical, RGB.....5

Typical Illuminance, Lux.....5

Electrical Performance6

Minimum, Typical, and Absolute, Maximum

Ratings - Whites.....6

Minimum, Typical and Absolute, Maximum

Ratings - RGB.....6

Spectral Distribution

Warm White7

Daylight White.....7

RGB8

Forward Current vs. Forward Voltage

Warm White9

Daylight White.....9

RGB10

Relative Luminous Flux vs. Junction Temperature

Warm White11

Daylight White.....11

RGB12

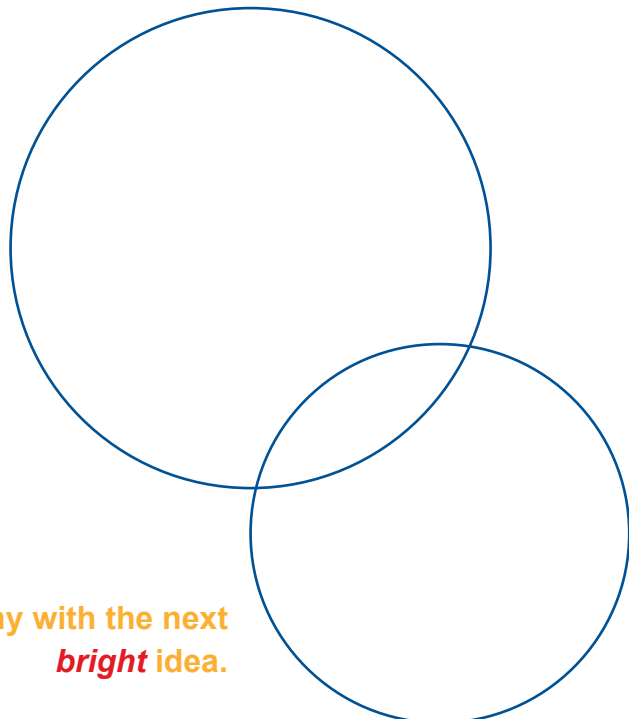

The company with the next
bright idea.

Table of Contents^{continued}

Luminous Flux vs. Current

Warm White	13
Daylight White.....	13
RGB.....	14

Efficacy vs. Current

Warm White	15
Daylight White.....	15
RGB	16

Bin Structures

Warm White	17
Daylight White.....	18

Projected Lumen Maintenance

Warm White, Daylight White,	19
-----------------------------------	----

Relative Luminous Intensity

Whites	20
RGB	20

Relative Luminous Intensity (Polar)

Whites	21
RGB	21

Mechanical Dimensions

Whites	22
RGB	22

Electrical Connections

Whites	23
RGB	23

Wiring Harness

Packaging Trays

Patents, Connections, Assemblies, Compliance, Notes, and Warranty Statement.....

Introducing Titan Light Engines

Lamina's LED light engines are manufactured by combining high brightness LED from industry-leading LED manufacturers with Lamina's proprietary packaging technology. This technology is a breakthrough in thermal performance for LED packaging, a key factor in determining LED life and reliability. Unmatched thermal performance coupled with package interconnectivity allows Lamina to densely cluster multiple LEDs to achieve exceptionally high luminous intensity in very small footprints.

Lamina's Titan Series is available in 3050K Warm White, 4700K Daylight White and RGB. The Titan 3050K Warm White delivers 600+ lumens from a single point. Enhanced red and orange color spectrum and make this product ideal for incandescent and halogen replacements. The Titan RGB, through three independently controlled input/output channels (red, green and blue), produces any of 16,000,000 beautifully saturated and blended colors (including white with variable color temperature) from a single point source.

the maximum in usable light. Titan makes possible applications which, until now, could only be accomplished with traditional lighting sources. Titan features:

- Integral Connector for easy Electrical Connection
- Designed for popular drive currents of 1050mA and 1400mA
- Lamina narrow, medium and wide beam optics available
- Isolated metal base - makes wiring in series or parallel possible on a common heat sink
- Integrated ESD protection - 4,000V HBM
- Superior thermal performance for improved reliability
- Long life and high lumen maintenance
- Lamina heat sinks and developer kits available for rapid prototyping

Lamina provides unmatched product integration support. Lamina's experienced sales application engineers, knowledgeable in LED design integration, optics, heat sinks, and electronics are just a phone call away. To request a sample or to speak with a sales applications engineer, call us at (609) 265-1401.

**LED Light Engines have never
been this *flexible*.**

Lamina's Light Engines

They feature the lowest thermal resistance of any LED package on the market. Our patented multi-layer on metal package

path to dissipate the LED's thermal energy.

This low thermal resistance gives you the choice to use a smaller heat sink or to run your parts at a higher power rating while still maintaining a safe junction temperature.

Contact the sales department at Lamina to discuss your design and get expert advice for designing your LED based product.

Flux Characteristics - Lumens Junction Temperature, $T_j = 25^\circ\text{C}$						
Product	Test Current (mA)	Typical (lm)	Min. (lm)	Drive Current (mA)	Typical (lm)	
NT-52D1-0430 Warm White	1050	539	417	1400	665	
NT-52D0-0429 Daylight White	1050	878	648	1400	1070	
NT-53F0-0428 RGB	R	1050	276	198	1400	383
	G	1050	307	230	1400	395
	B	1050	78	58	1400	104

Table 1.

Optical Characteristics, Whites						
Product	Color Temp. Min. (K°)	Color Temp. Max. (K°)	Total Incl. Angle	View Angle ⁽¹⁾	CRI Min	CRI Typ.
NT-52D1-0430 Warm White	2750	3550	140	60	70	78
NT-52D0-0429 Daylight White	3950	6200	140	61	62	78

Table 2. ⁽¹⁾Note:

of the peak value.

Optical Characteristics, RGB					
Product	Dominant Wave Length Min.	Dominant Wave Length Max.	Total Incl. Angle	View Angle ⁽¹⁾	
NT-53F0-0428 RGB	R	619	629	130	61
	G	515	535	130	62
	B	460	470	130	58

Table 3. ⁽¹⁾Note:

of the peak value.

Typical Illuminance Characteristics - Lux						
Product	Drive Current (mA)	Distance from Source (Meters)				
		1	2	5	10	
NT-52D1-0430 Warm White	1050	535.9	134.0	21.4	5.4	
NT-52D1-0430 Warm White	1400	661.2	165.3	26.4	6.6	
NT-52D0-0429 Daylight White	1050	795.6	198.9	31.8	8.0	
NT-52D0-0429 Daylight White	1400	969.0	242.3	38.8	9.7	
NT-53F0-0428 RGB, Red	1050	275.5	68.9	11.0	2.8	
NT-53F0-0428 RGB, Red	1400	382.3	95.6	15.3	3.8	
NT-53F0-0428 RGB, Green	1050	286.4	71.6	11.5	2.9	
NT-53F0-0428 RGB, Green	1400	368.5	92.1	14.7	3.7	
NT-53F0-0428 RGB, Blue	1050	89.0	22.3	3.6	0.9	
NT-53F0-0428 RGB, Blue	1400	102.0	25.5	4.1	1.0	

Table 4.

Driving Lamina Light Engines

Lamina's Titan light engines are designed to operate under current controlled conditions, either constant current, PWM or other current control methods. The Titan family is designed to operate using commercially available driver sources from many electronic power supply companies. Lamina's Application Engineering team can assist with the proper selection of drivers and can assist with guidance on your own drive current design.

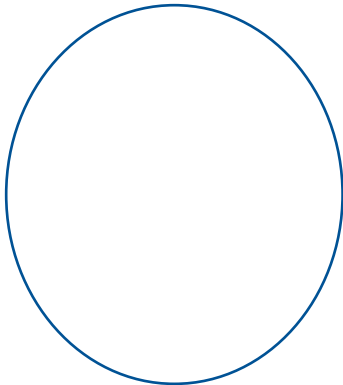

Photo courtesy of XXD
Produktdesign GmbH www.xxd.de

Electrical Performance Characteristics Junction Temperature, $T_j = 25^\circ\text{C}$							
Product	Forward Voltage (VDC)		Typical Power (W)	Typical Temperature Forward Voltage (mV/°C)	Current (mA)	Typical Thermal Resistance Junction to Case (°C/W)	
	Typ.	Max.					
NT-52D1-0430 Warm White	22.8	25.8	32.0	2.0	1400	0.9	
NT-52D0-0429 Daylight White	23.5	26.6	32.9	2.0	1400	0.9	
NT-53F0-0428 RGB	R	7.1	8	9.9	0.5	1400	1.8
	G	10.8	12.2	15.1	1.0	1400	1.8
	B	11.4	12.9	16.0	1.0	1400	1.8
NT-53F0-0428 RGB Combined Typical					1400	0.8	

Table 5.

Minimum, Typical, and Absolute Maximum Ratings Warm White NT-52D1-0430, Daylight White NT-52D0-0429					
	Symbol	Min.	Typ.	Max.	Unit
Thermal Resistance ¹	T_R	-	0.7	0.7	°C/W
Insulation Resistance ²	-	1.0	-	1.8	
Electrical Isolation ³	-	100	-	-	V
Reverse Current	-	-	-	50	mA
Reverse Voltage	-	-	-	5	V
LED Junction Temperature ⁴	T_j	-	-	125	°C
Storage Temperature	-	-40	-	+100	°C
Assembly Temperature	-	-	-	100	°C
ESD Sensitivity	HBM	-	-	4000	V
Current	mA	-	-	1500	mA DC

Figure 6.

1. Thermal resistance is measured from LED junction to case.
2. Insulation resistance between any terminal and base.
3. Electrical isolation voltage between any terminal and base.
4. Lower junction temperatures improve lumen maintenance.

Minimum, Typical, and Absolute Maximum Ratings RGB NT-53F0-0428					
	Symbol	Min.	Typ.	Max.	Unit
Thermal Resistance ¹	T_R	-	0.5	.7	°C/W
Thermal Resistance Per Color ¹	-	-	1.4	1.8	°C/W
Insulation Resistance ²	-	1.0	-	-	
Electrical Isolation ³	-	100	-	-	V
Reverse Current	-	-	-	50	mA
Reverse Voltage	-	-	-	5	V
LED Junction Temperature ⁴	T_j	-	-	125	°C
Storage Temperature	-	-40	-	+100	°C
Assembly Temperature	-	-	-	100	°C
ESD Sensitivity	HBM	-	-	4000	V
Current Per Color	mA	-	-	1500	mA

Table 7.

1. Thermal resistance is measured from LED junction to case all color channels driven.
2. Insulation resistance between any terminal and base.
3. Electrical isolation voltage between any terminal and base.
4. Lower junction temperatures improve lumen maintenance.

**Spectral Distribution, Warm White NT-52D1-0430
@1050, 25°C Heat Sink**

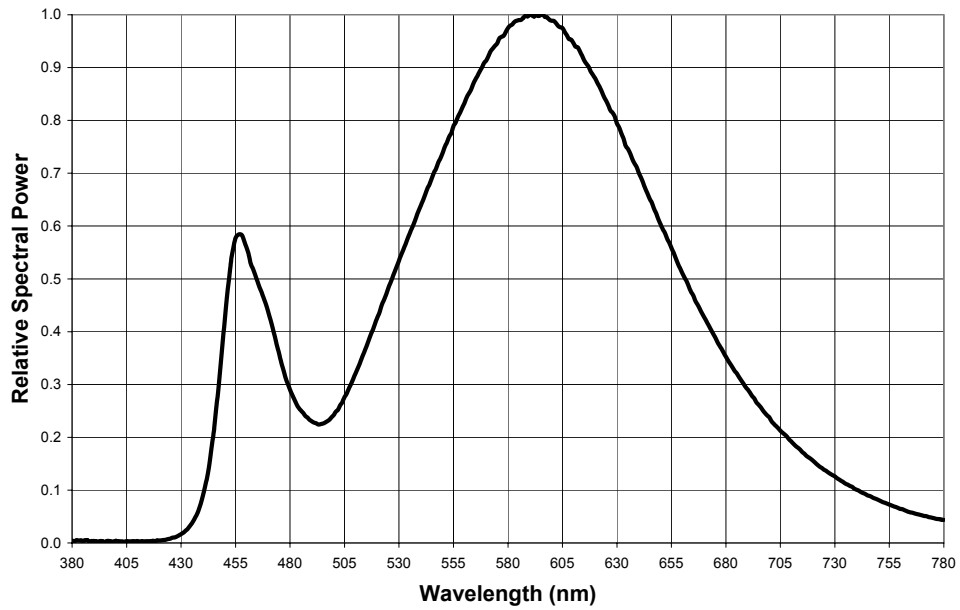

Figure 1.

**Spectral Distribution, Daylight White NT-52D0-0429
@1050, 25°C Heat Sink**

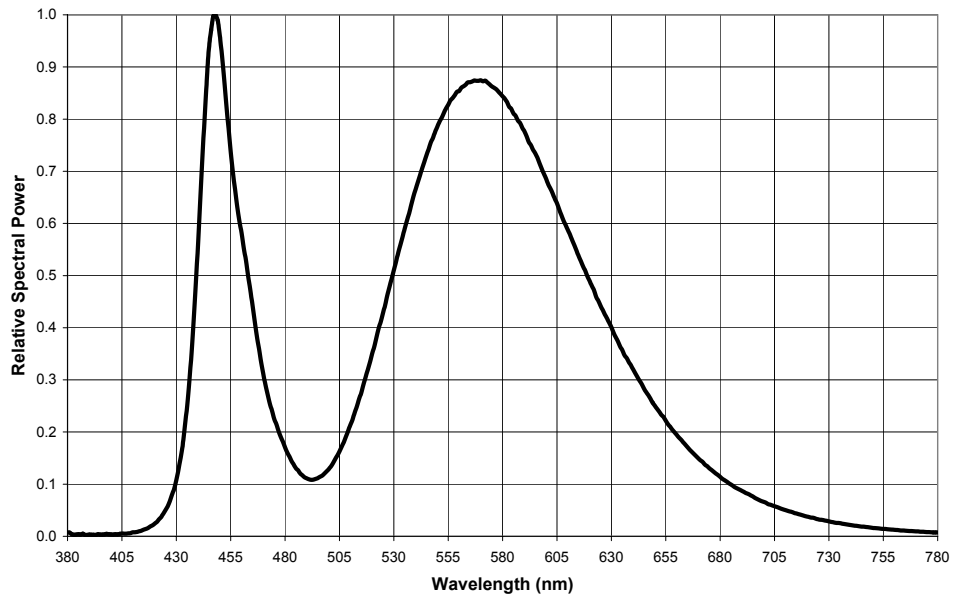

Figure 2.

**Spectral Distribution, NT-53F0-0428 RGB
@1050, 25°C Heat Sink**

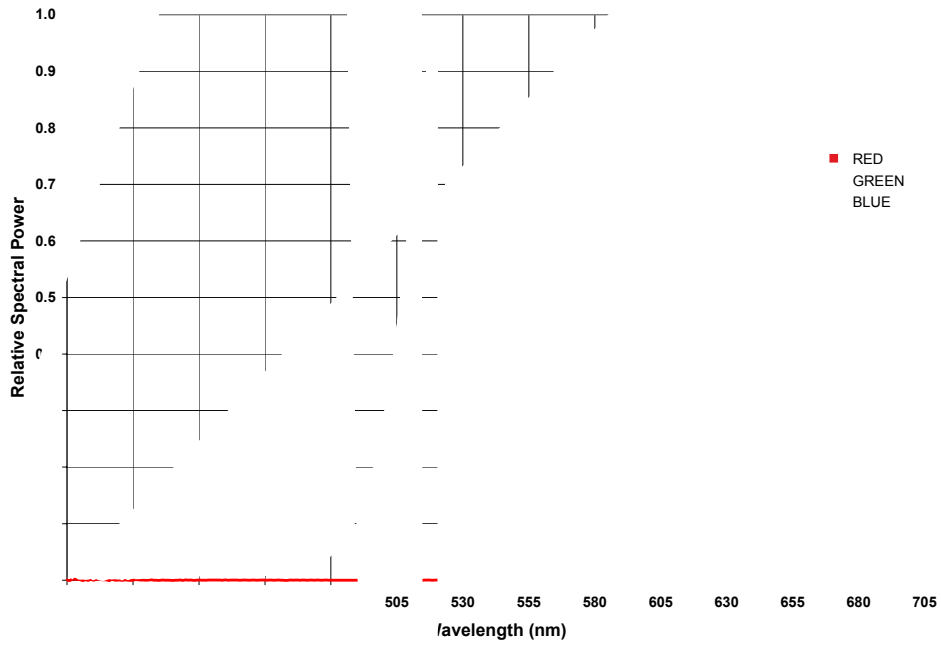

Figure 3.



**Forward Current vs. Forward Voltage,
Warm White NT-52D1-0430**

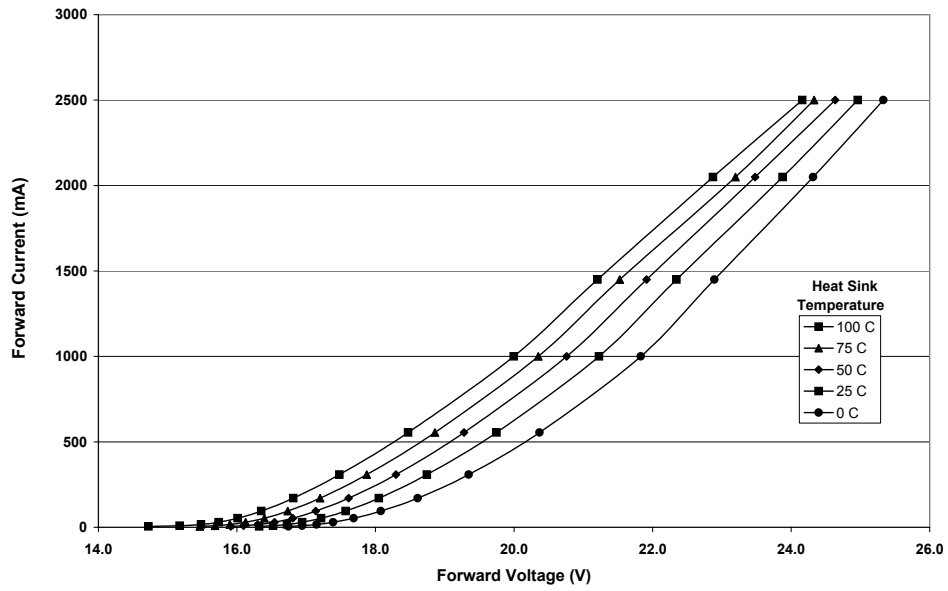

Figure 4.

**Forward Current vs. Forward Voltage,
Daylight White NT-52D0-0429**

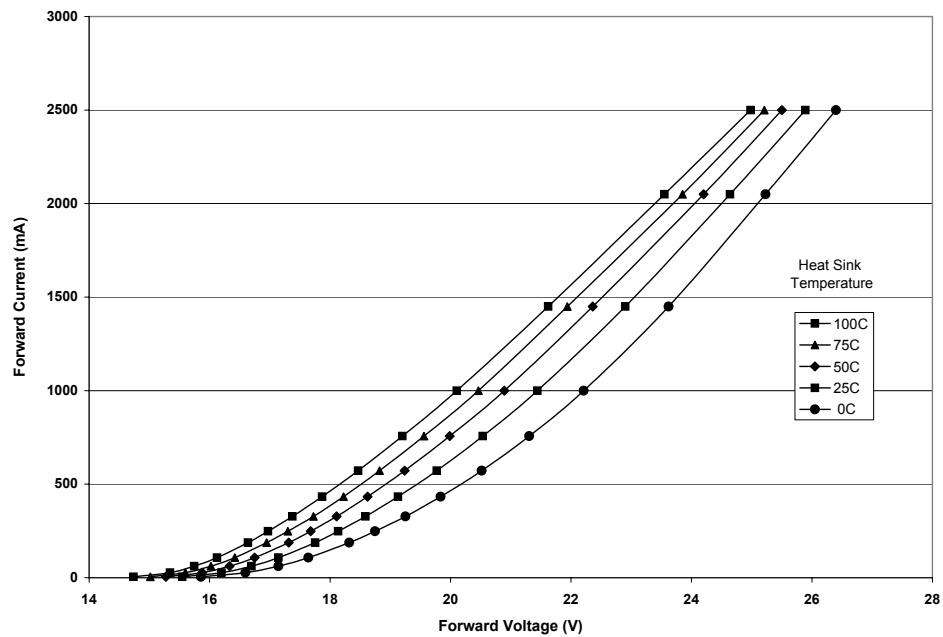
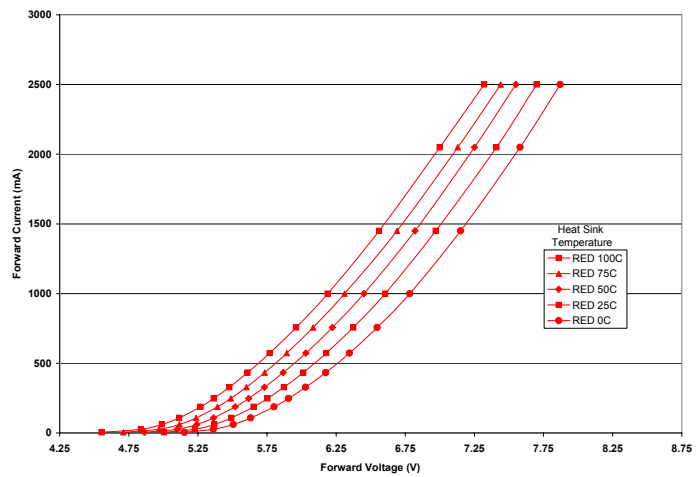

Figure 5.

Forward Current vs. Forward Voltage, Red NT-53F0-0428

Figure 6A.



Forward Current vs. Forward Voltage, Green NT-53F0-0428

Figure 6B.

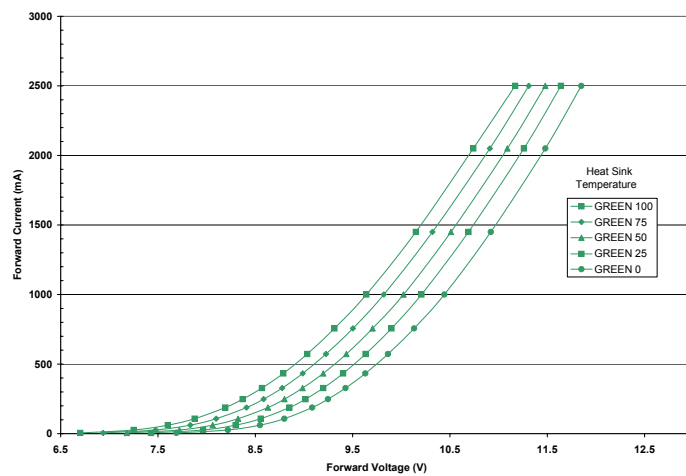

Forward Current vs. Forward Voltage, Blue NT-53F0-0428

Figure 6C.

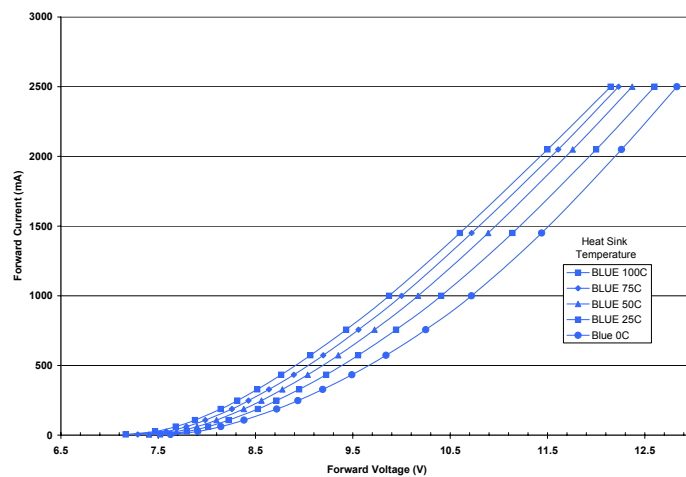

**Relative Luminous Flux vs. Junction Temperature,
Warm White NT-52D1-0430**

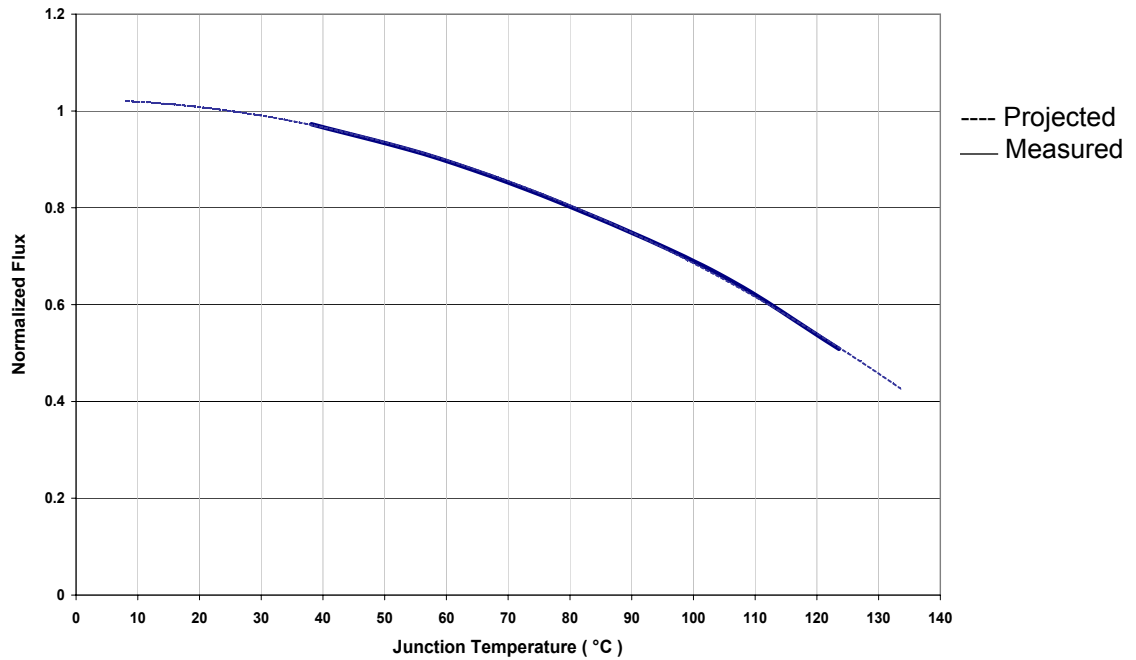

Figure 7.

**Relative Luminous Flux vs. Junction Temperature,
Daylight White NT-52D0-0429**

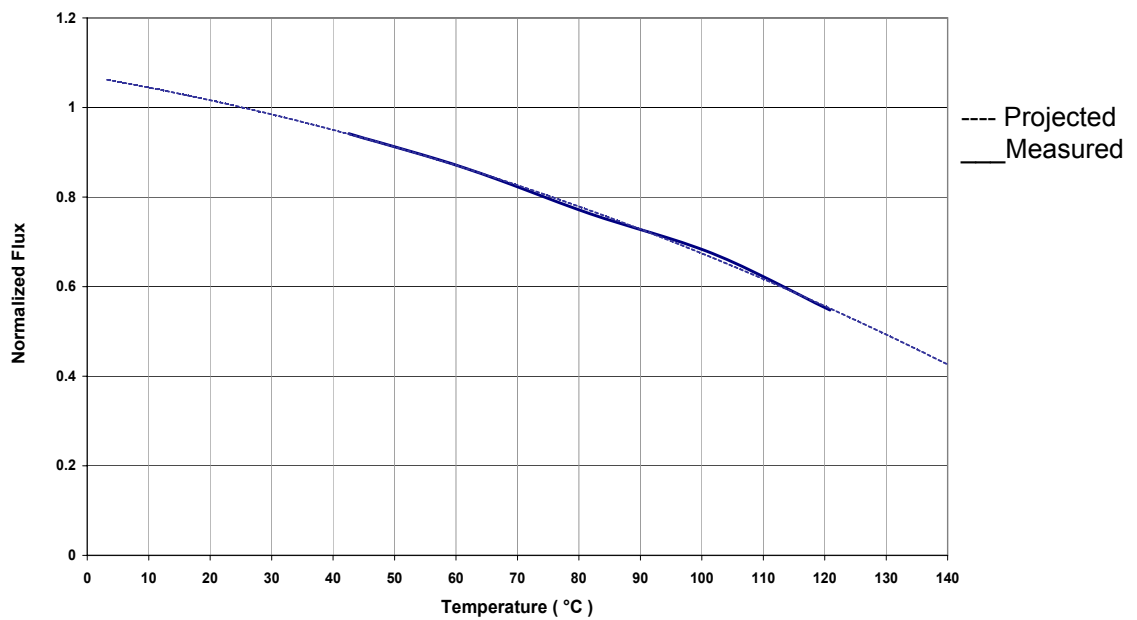

Figure 8.

**Relative Luminous Flux vs. Junction Temperature,
RGB NT-53F0-0428**

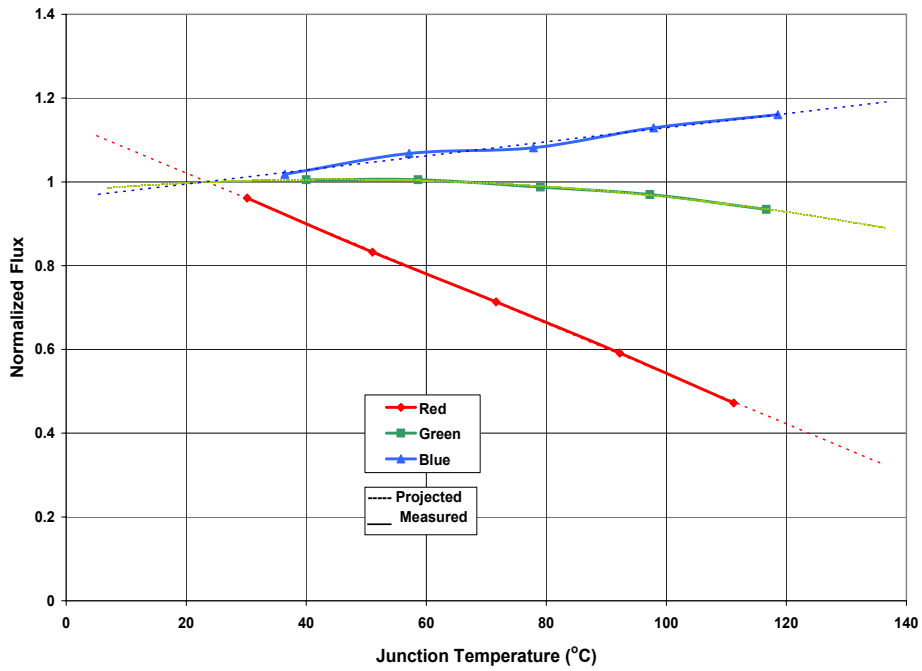
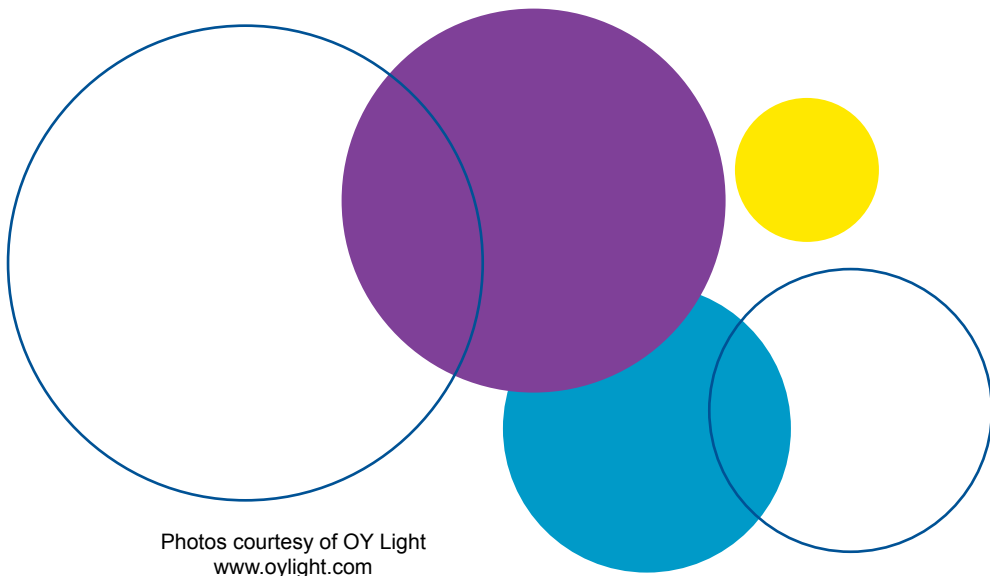

Figure 9.



**Luminous Flux vs. Current,
Warm White NT-52D1-0430**

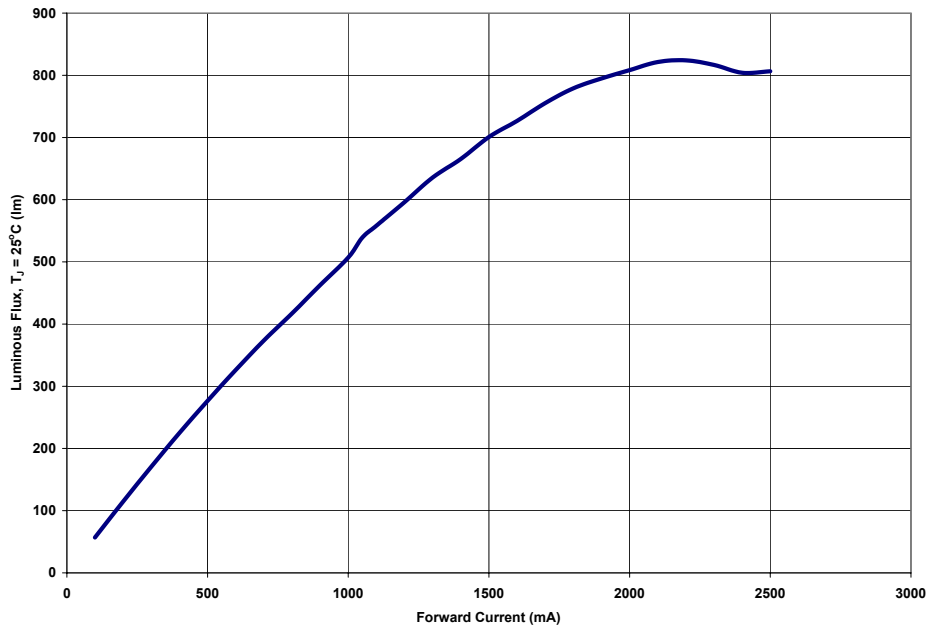

Figure 10.

**Luminous Flux vs. Current,
Daylight White NT-52D0-0429**

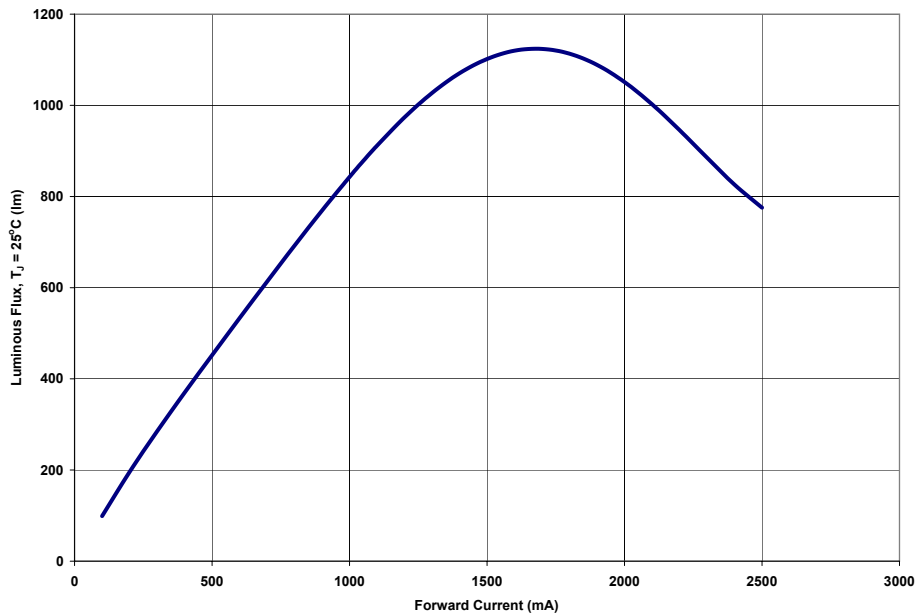

Figure 11.

**Luminous Flux vs. Current,
RGB NT-53F0-0428**

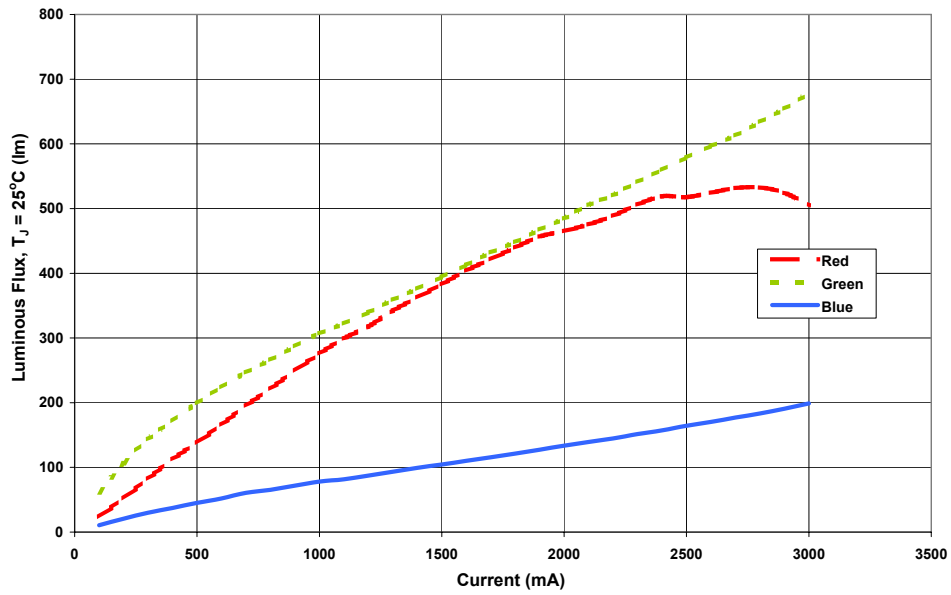

Figure 12.

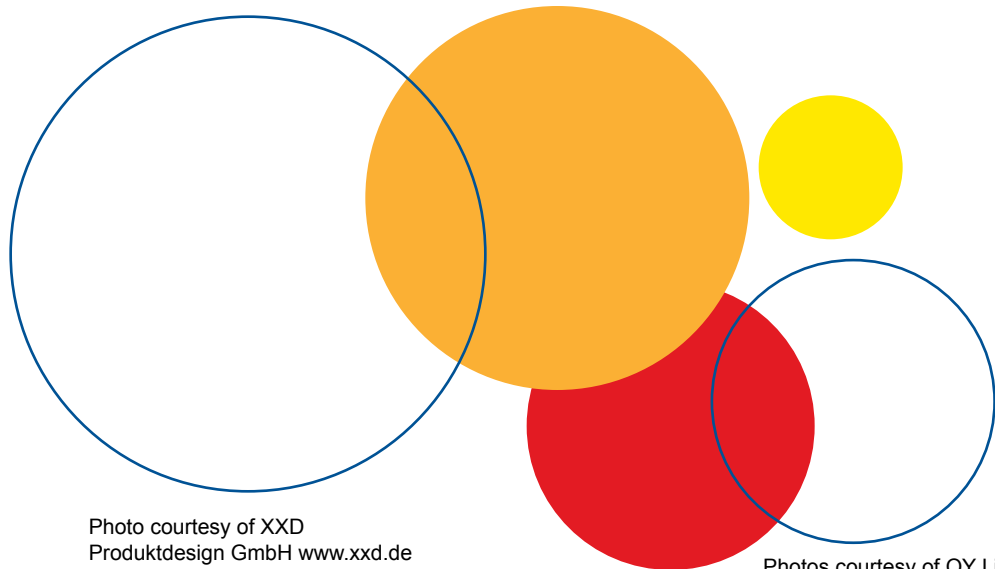

Photo courtesy of XXD
Produktdesign GmbH www.xxd.de

Photos courtesy of OY Light
www.oilight.com

**Efficacy vs. Current,
Warm White NT-52D1-0430**

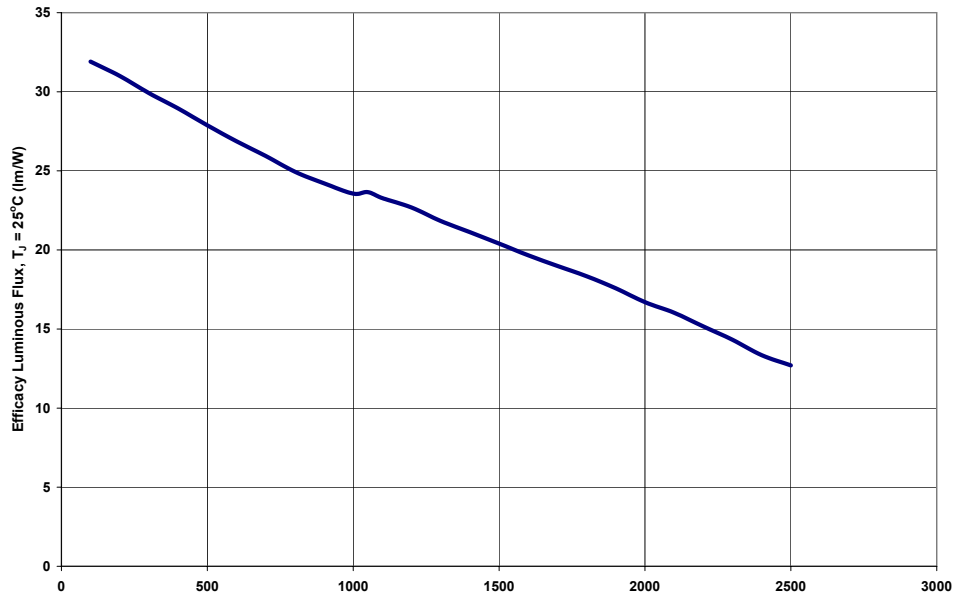

Figure 13.

**Efficacy vs. Current,
Daylight White NT-52D0-0429**

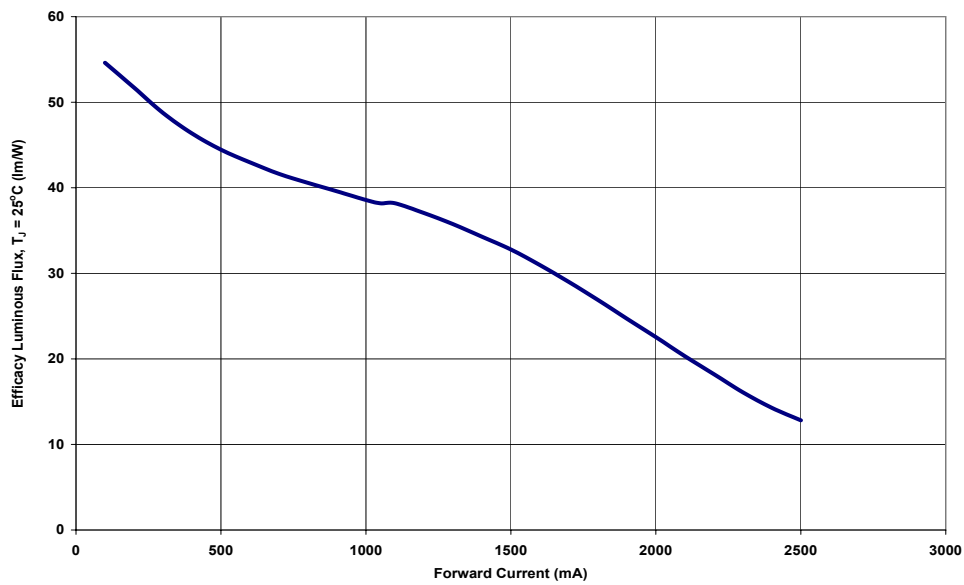

Figure 14.

**Efficacy vs. Current,
RGB NT-53F0-0428**

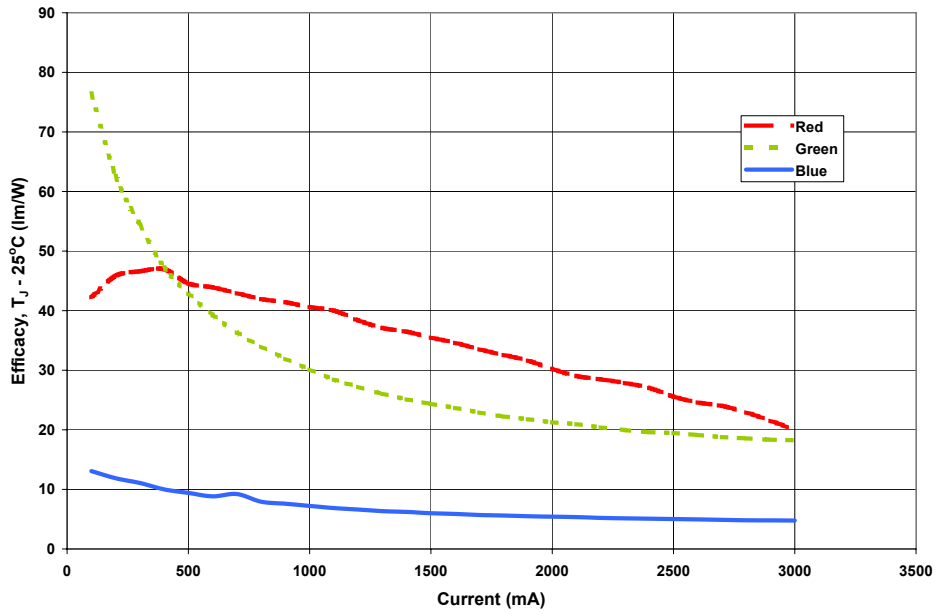
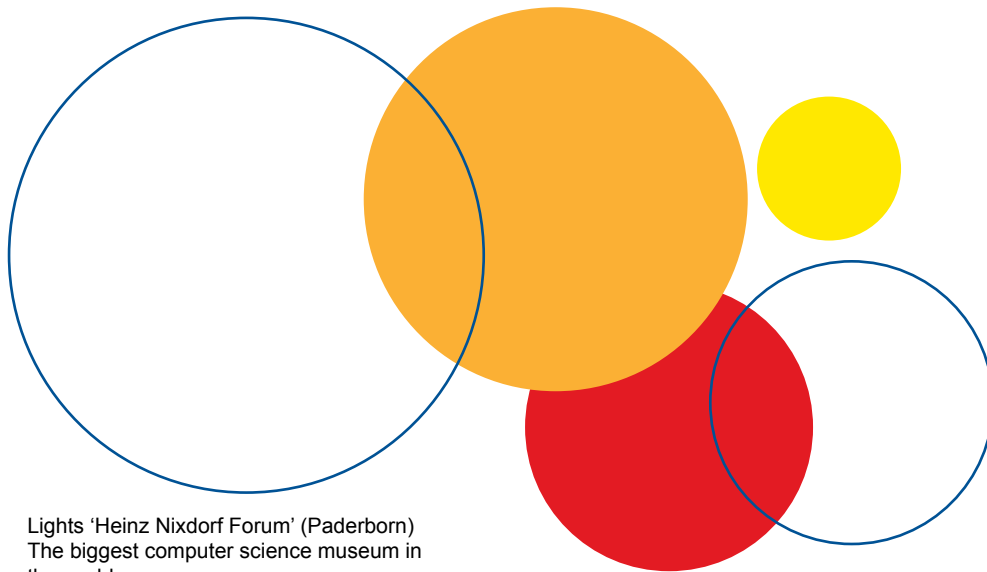

Figure 15.



Lights 'Heinz Nixdorf Forum' (Paderborn)
The biggest computer science museum in
the world.

Bin Structure Warm White NT-52D1-0430

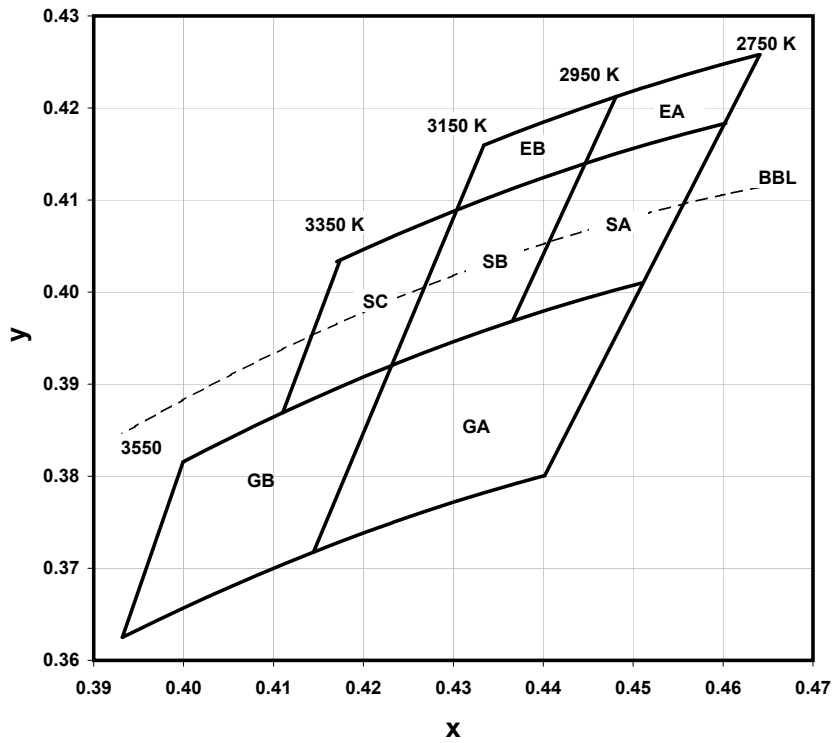
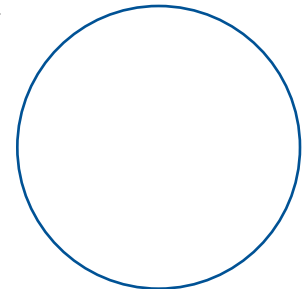

Figure 16. CIE Reference 1931, 2°

Bin Code	X	Y	Typical CCT (°K)
EB	0.4481	0.4212	3050
	0.4448	0.4140	
	0.4305	0.4089	
	0.4334	0.4159	
EA	0.4641	0.4258	2850
	0.4603	0.4183	
	0.4448	0.4140	
	0.4481	0.4212	
SC	0.4305	0.4089	3250
	0.4232	0.3920	
	0.4110	0.3869	
	0.4174	0.4034	
SB	0.4448	0.4140	3050
	0.4366	0.3968	
	0.4232	0.3920	
	0.4305	0.4089	

Bin Code	X	Y	Typical CCT (°K)
SA	0.4603	0.4183	2850
	0.4510	0.4009	
	0.4366	0.3968	
	0.4448	0.4140	
GB	0.4232	0.3920	3350
	0.4144	0.3717	
	0.3932	0.3625	
	0.3999	0.3815	
GA	0.4510	0.4009	2950
	0.4401	0.3800	
	0.4144	0.3717	
	0.4232	0.3920	

Table 8. Typical relative Warm White Bin Structure - NT-52D1-0430.



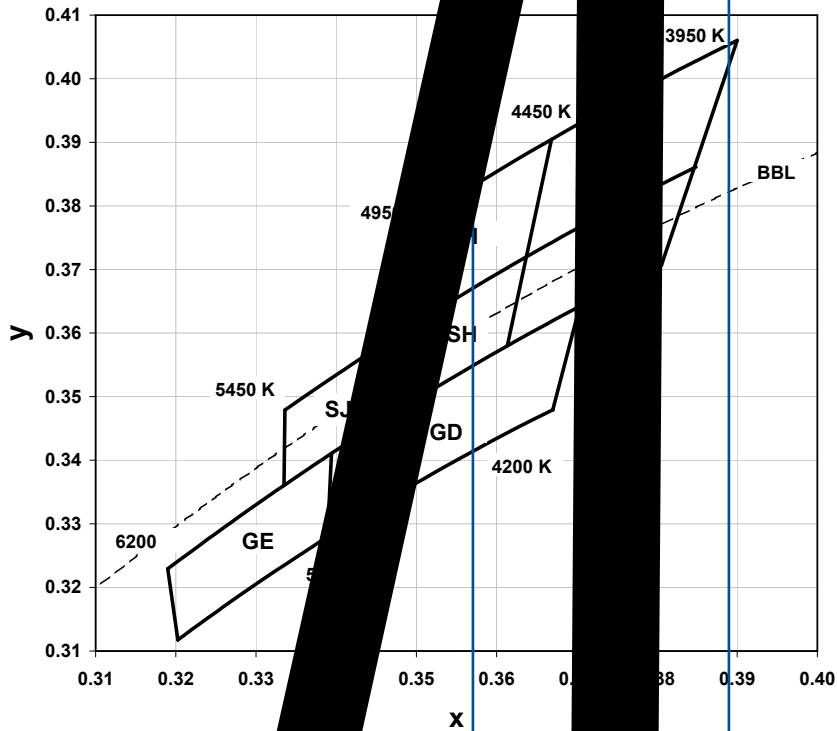

Bin Code	X	Y	
EH	0.3668	0.3904	
	0.3637	0.3719	
	0.3469	0.3591	
	0.3483	0.3761	
EG	0.3900	0.4060	4200
	0.3848	0.3861	
	0.3637	0.3719	
	0.3668	0.3904	
SJ	0.3469	0.3591	5200
	0.3460	0.3464	
	0.3335	0.3360	
	0.3336	0.3479	
SH	0.3637	0.3719	4700
	0.3613	0.3580	
	0.3460	0.3464	
	0.3469	0.3591	

Table 9. Relative Daylight White Bin
Code - NT-52D0-0429.

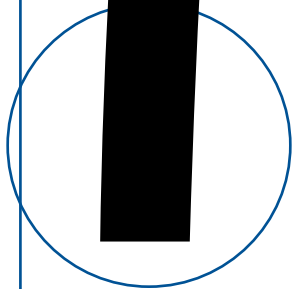

Projected Lumen Maintenance

The NT-52D1-0430 - Warm White and NT-52D0-0429 - Daylight White will deliver 70% lumen maintenance at 50,000 hours of operation at a forward current of 1050mA. This projection is based on constant current operation with junction temperature maintained at or below 120°C. The NT-53F0-0428, RGB will deliver, 70% lumen maintenance at 50,000 hours of operation at a forward current of 1050mA. This projection is based on constant current operation with junction temperature maintained at or below 120°C.

This performance is based on independent test data, Lamina's historical data from tests run on similar material systems, and internal reliability testing. Observation of design limits included in this data sheet is required in order to achieve this projected lumen maintenance.

Projected Lumen Maintenance

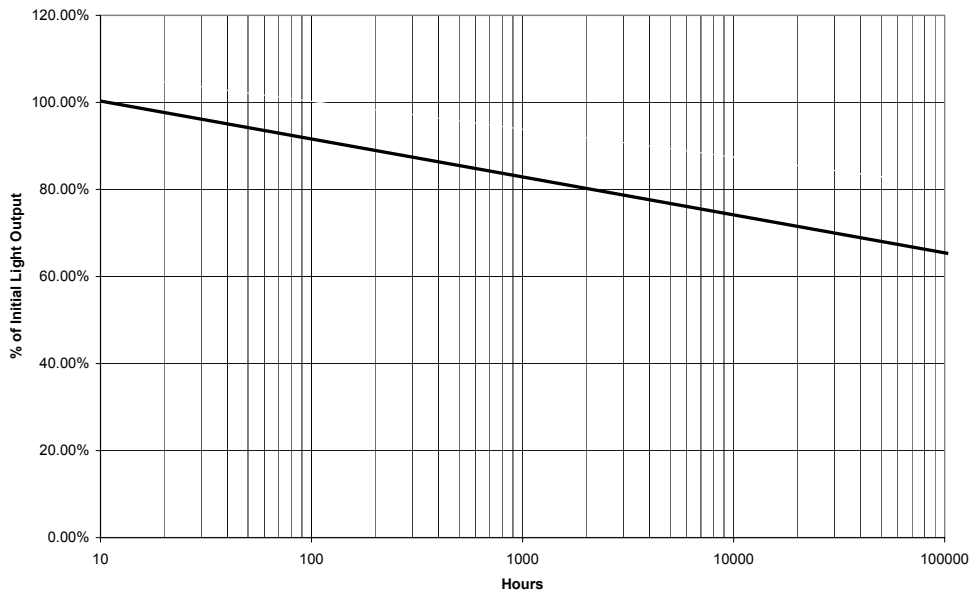

Figure 18.

**Relative Luminous Intensity,
Warm White NT-52D1-0430 and Daylight White NT-52D0-0429**

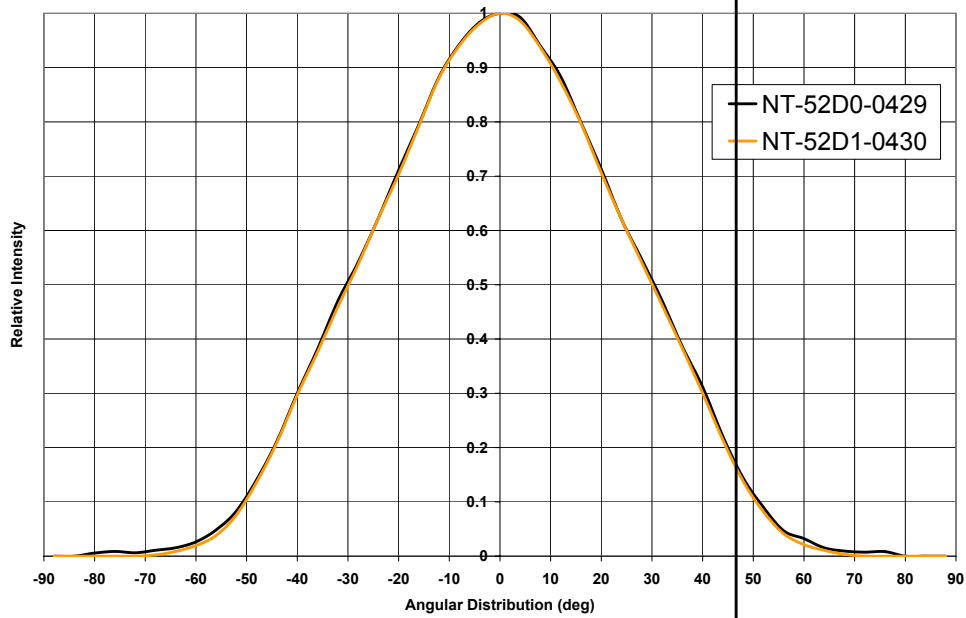

Figure 21.

**Relative Luminous Intensity,
RGB NT-53F0-0428**

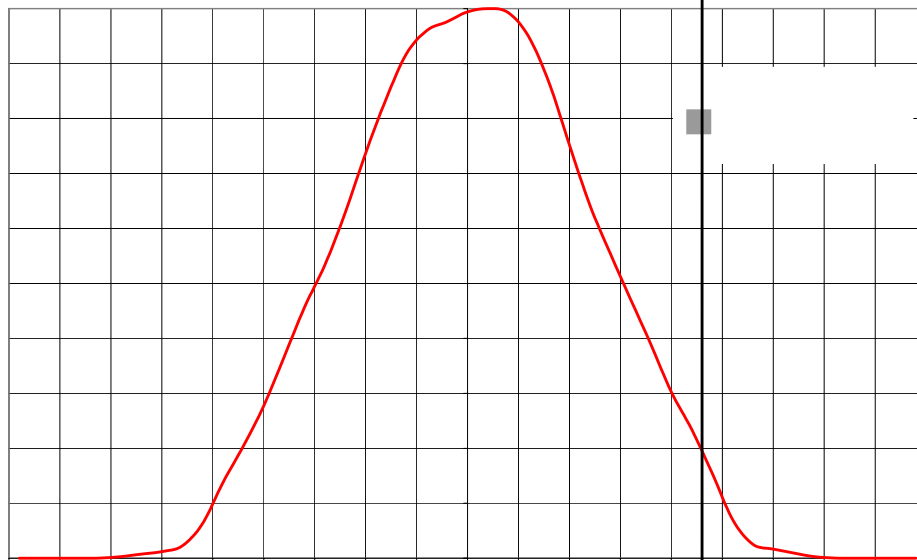

Figure 22.

distributions can be produced by use of secondary optics. Please contact a Application Engineer at Lamina for support with your optical needs.

Relative Luminous Intensity, (Polar)
Warm White NT-52D1-0430 and Daylight White NT-52D0-0429

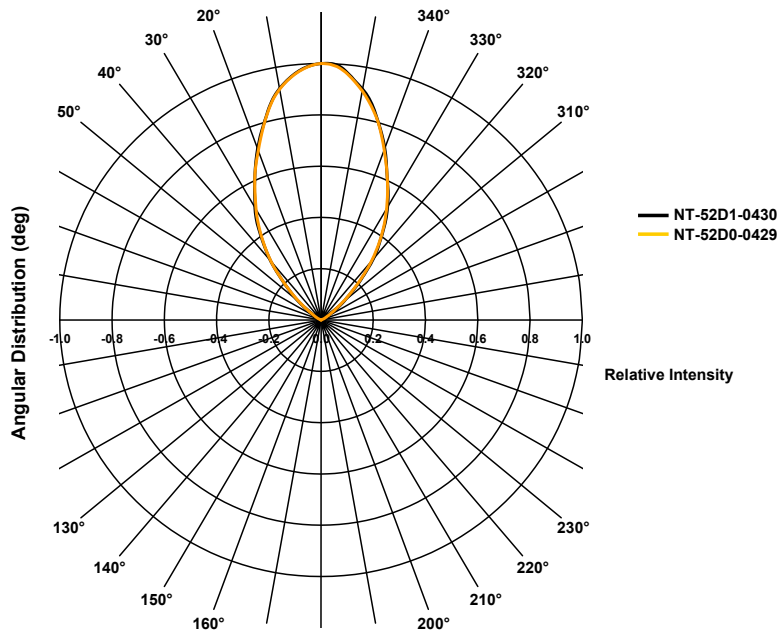

Figure 23.

Relative Luminous Intensity, (Polar)
RGB NT-53F0-0428

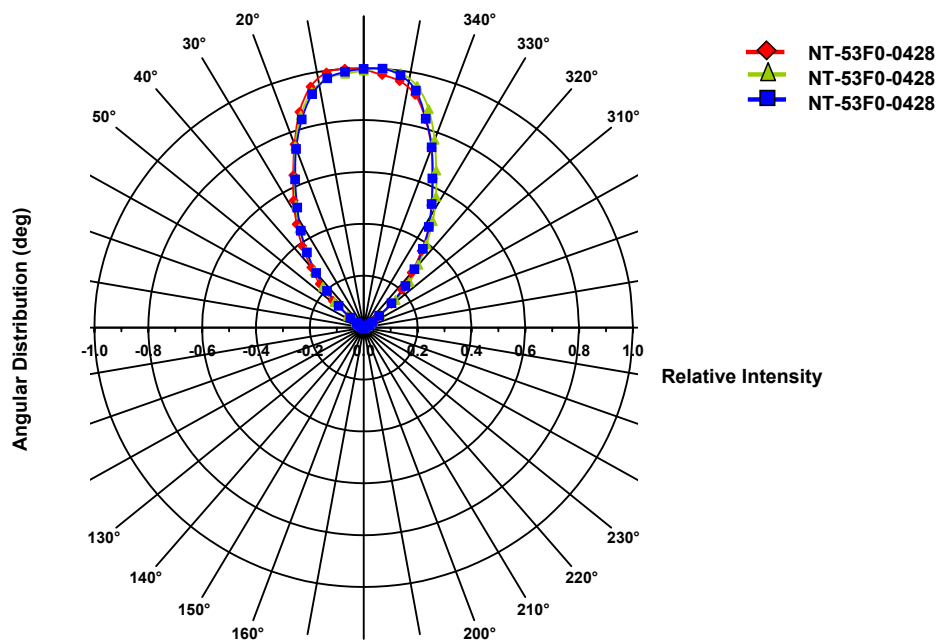

Figure 24.

**Mechanical Dimensions,
Warm White NT-52D1-0430 and Daylight White NT-52D0-0429**

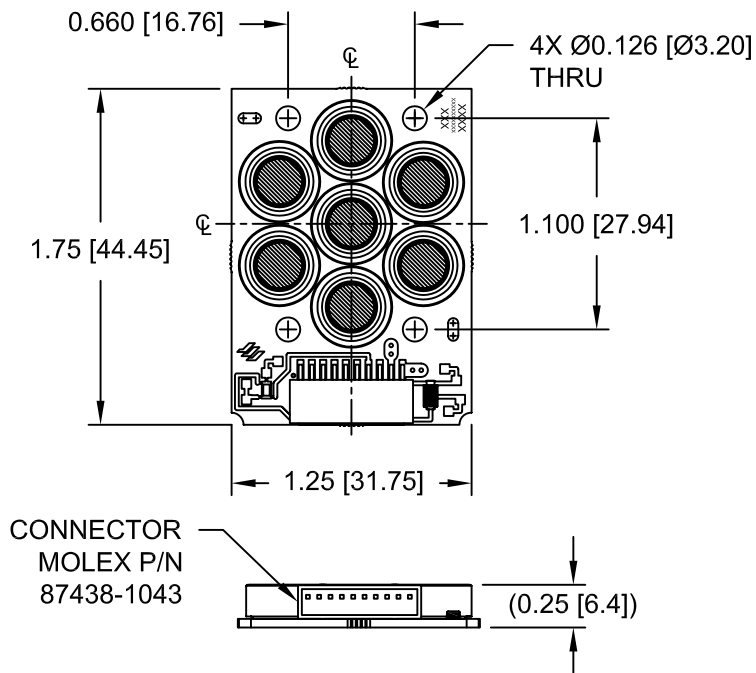

Figure 25.

All dimensions are for reference only Mechanical NT-52D1-0430 and NT-52D0-0429. Do not handle device by the lens. Care must be taken to avoid damage to the lens. Drawing not to scale.

**Mechanical Dimensions,
RGB NT-53F0-0428**

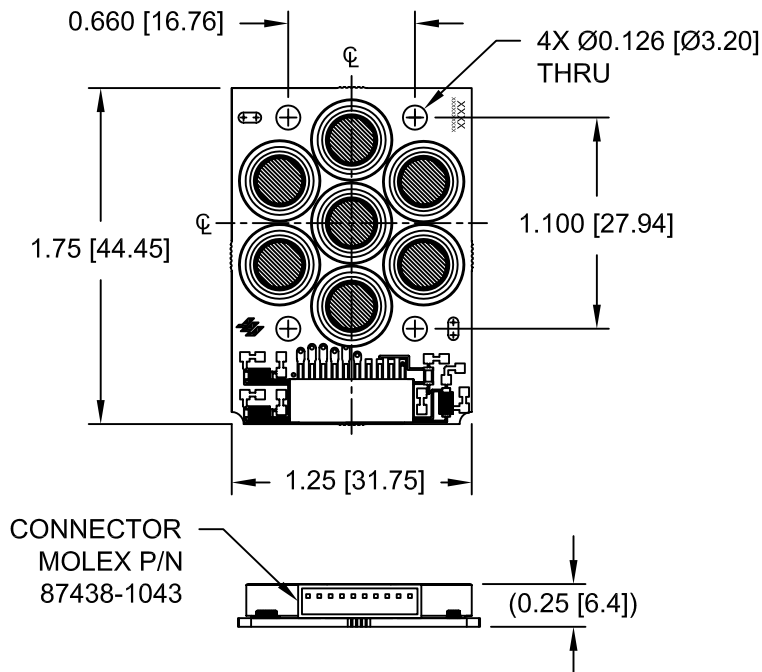
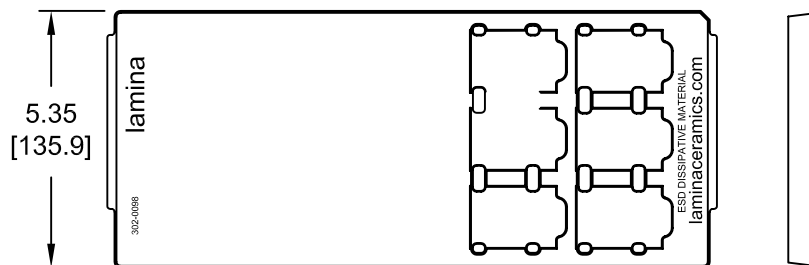

Figure 26.

All dimensions are for reference only Mechanical NT-53F0-0428 Do not handle device by the lens. Care must be taken to avoid damage to the lens. Drawing not to scale.



Patents

Lamina's light engines may be covered by pending patents and/or one or more of the following U.S. and/or International patents 5876536, 6709749 B, 595880, 6017642, 5565262, 5681444, 5653834, 5581876, 5847935, 5514451, 5747931, 5925203, 5725808, 5929510, 5858145, 5866240, 5953203, 6055151, 614076, 6011330, 6399230, 6914501, 6168490, 6191934, 614075, 6160469, 6300267, 6471805, 6518502, 6739047, 6720859, 6759940, 6518502, 6670856 B1, 6720859, 6713862 B2, WO 00/47399, WO 00/26152, WO 98/19339, 5082804, ZL99808762.9, 69623930, 69628549, 69629572, 805785, 69628549, 843621, 932500, 805785, 812258, 843621, 932500, 805785, 812258, 843621, 932500, 3327556, 3267299, 3226281, 3405545, 320630, 295695, 284068, 546471, 805785, 812258, 843621, 6455930, 6759940, 6713862, 7095053, 7098483.

Electrical Connections

The Titan LED light engines connectors for solderless connections to Lamina's wiring harness.

For more information refer to Lamina's Connection application note which can be found on the website at www.laminaceramics.com.

Functional test: Parts may be illuminated for functional test using a constant current source set at 25% of Drive Current for no more than two seconds without heat sink. Voltage compliance of the power source should be no greater than max forward voltage +5V.

2. When using constant current LED drivers with high compliance voltage (Advance, LEDworks, etc. or a custom driver) the output of the supply must be connected to the part before power is applied to the input of the supply.

Assembly Recommendations

Lamina's Titan Series Light Engines are designed for attachment to a heat sink with conductive epoxy, or screw head or metric equivalent M3 x 0.5 cheese head screw, 18-8 SS is recommended. When mounting the light engine, inch pounds (56 Newton-centimeters), and then tighten each to a maximum torque of 5 inch pounds (45 Newton-centimeter). Flatness requirement of the surface that the light engine is mounted to is 0.001 inch/inch (1mm/meter). To prevent damage when using conductive epoxy do not use mounting screws.

screws and thermal tape may damage the device.

Receiving Parts and Packaging Trays

shipment and to take up the least amount of space in your storage area.

Notes

react with silicone compounds." See Dow Chemical Form 45-0113D-01, Silicone Fluid Resistance Guide.

2. Ray trace models are available upon request.
3. Lamina may make process or materials changes affecting the performance or other characteristics of our not be identical to product supplied as samples or under prior orders.

thermal tape may damage the device.

Lamina Light Engines Comply with RoHS Restrictions

Lamina Titan Light Engines are compliant with all of the criteria proposed by the European RoHS Directive 2002/95/EC for hazardous material content in electronic and electrical equipment as listed in Annex 1A and 1B of the WEEE Directive.

In addition to containing no mercury, Lamina's LED Light Engines have the following environmental advantages over traditional light sources:

- Long lifetime
- Fully dimmable
- Very low IR and UV radiation



Warranty Statement

Lamina Ceramics Inc. (Seller) extends warranty on goods produced by the Seller for one (1) year from original date of shipment, that the goods sold hereunder are new and free from substantive defects in workmanship and materials. This warranty extends only to the Buyer and not to indirect purchasers or users. Seller's liability under the foregoing warranty is limited to replacement of goods or repair of defects or refund of the purchase price at the seller's sole option. The above warranty does not apply to defects resulting from the improper or inadequate

□ abuse, neglect or accident. □

THE ABOVE WARRANTY IS EXCLUSIVE AND NO OTHER WARRANTY, WHETHER WRITTEN OR ORAL, IS EXPRESSED OR IMPLIED. LAMINA CERAMICS INC. SPECIFICALLY DISCLAIMS THE IMPLIED WARRANTIES OF MERCHANTABILITY AND FITNESS FOR A PARTICULAR PURPOSE.

120 Hancock Lane • Westampton, NJ 08060

□
609.265.1401 • 800.808.5822