

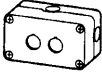

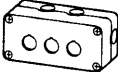

RMQ 22

Surface Mounting Enclosures

Control Circuit Devices

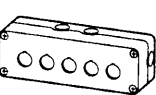
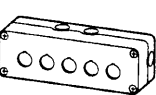
	Number of locations	Cable entry knockouts		Max. number of lamps in simultaneous operation	Type	Article no.	Price See Price List	Std. pack
		Bottom	Sides:					
	Quantity	Quantity × PG...		Max.	Colour ¹⁾			
Surface mounting enclosure IP 65 <small>totally insulated</small>								
With moulded cover fixing screws Cannot be used to mount: EC..., BFT..., BCE(L) 24								
Emergency-stop button	1	1×13.5	3×16	-				1 off
	1	1×13.5	3×16	1	IGE1M 081696			
	2	2×13.5	3×16	2	I1M 038834			
	3	2×13.5	4×16	2	I2M 041207			
	4	2×13.5	4×16	3	I3M 043580			
	5	2×13.5	4×16	4	I4M 045953			
					I5M 048326			
One-way screws								
For securing enclosure against tampering								
					ES-IM 050699			4 off
					ES-IGE 060244			4 off
Surface mounting enclosure IP 65 <small>totally insulated</small>								
With quick-release fastener for cover and base plate for EK...C Enclosure pebble grey Cannot be used to mount: EC..., BFT..., BCE(L) 24								
	12	-	1×21/16 ²⁾ 2×29/16 ²⁾	4		I12M 053072		1 off

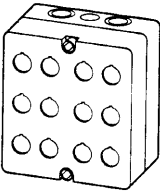
Notes

- ¹⁾ Colour: Yellow RAL 1004, enclosure cover light grey RAL 7032, enclosure base anthracite RAL 7016
²⁾ Cable entry at top and bottom

Style: flush mounting

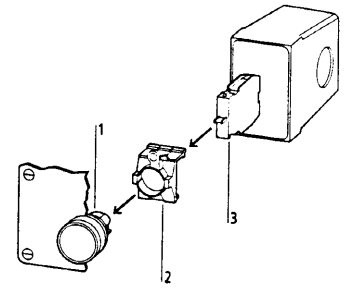

Style: surface mounting

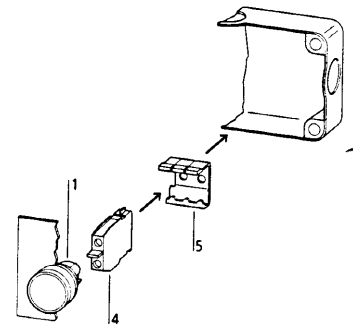

Accessories

Accessories	Page
1 Actuator	03/014
2 Fixing adapter	03/036
3 Contact element	03/036
4 Contact element	03/037
5 Fixing adapter	03/037
Button plate	03/044
Legend plate	03/052
Accessories	03/057

For networking

AS interface	01/046
--------------	--------