

SINGLE PHASE FILTERS

*for chassis- and
PCB-mounting*

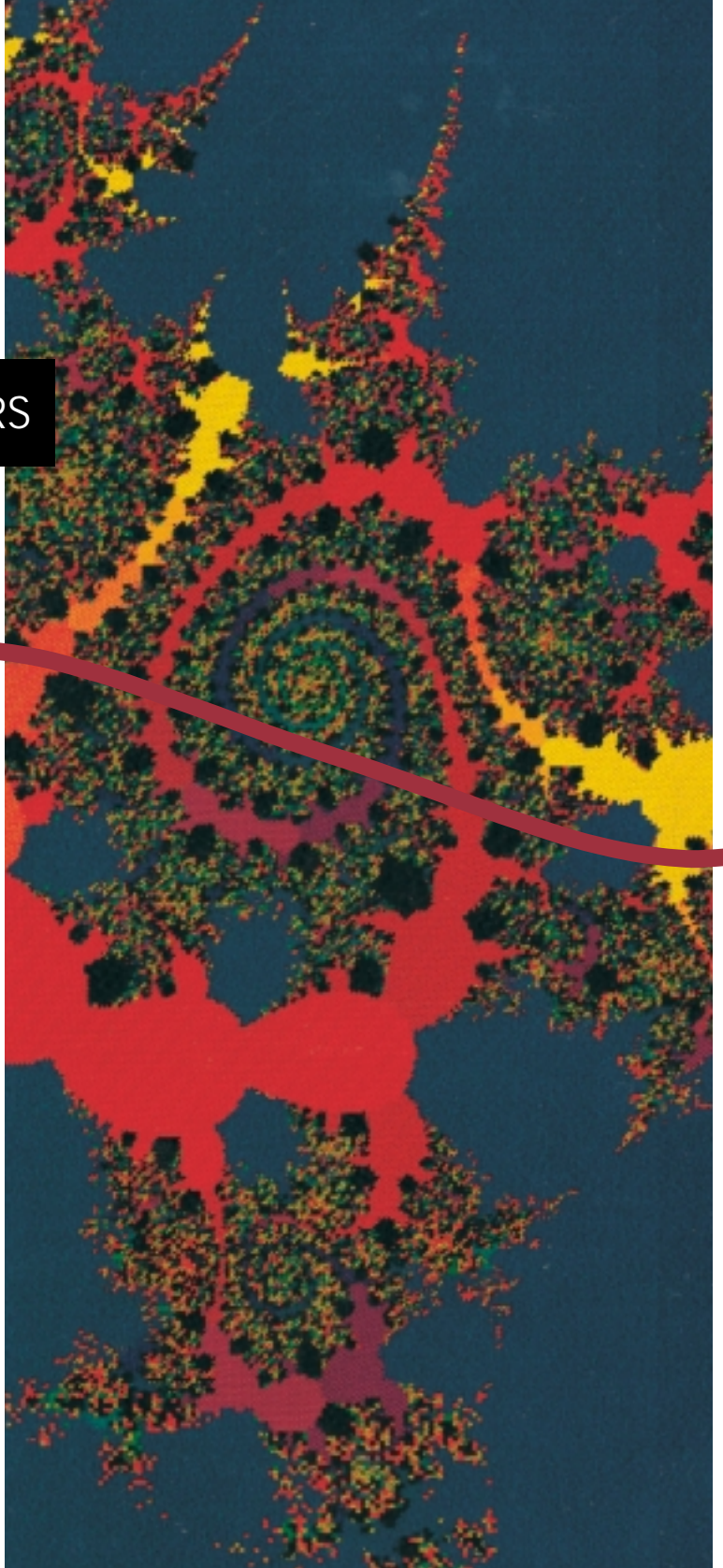

SCHAFFNER

Your number one name for EMC

Single-phase filters for chassis- and PCB-mounting

CONTENTS

General information	
Introduction to single-phase filters	2
Filter selection chart	3
Understanding EMC standards & filter specifications.....	4
EMC measurement & engineering services	8
Ordering information.....	9
Technical data	
FN 22	10
FN 250	12
FN 332	14
FN 343	16
FN 346	18
FN 350	20
FN 352Z	22
FN 357	24
FN 401	26
FN 402	28
FN 405	30
FN 406	32
FN 410	34
FN 420	36
FN 610	38
FN 612	40
FN 660	42
FN 670	44
FN 680	46
FN 685	48
FN 700Z	50
FN 9675	52
Mechanical Data	54 - 60
Addresses and contact information	61



Powerline filters

- a vital element of today's electronic designs

In today's world, more electrical energy is being generated at increasing levels of power, and more and more low power energy is being used for the transmission and processing of data. The result is vastly increased 'electronic smog' or noise. This noise can disrupt, and even destroy, electronic devices: an unacceptable situation, and shortly an illegal one in certain markets. **The electronics industry must strive to protect equipment against such 'noise'.**

Noise, or interference, travels two ways. Switches - such as semiconductors - can emit interference, and be susceptible to it. The same is true for data processing equipment. The most common method of protection is the use of powerline filters coupled with screening or gasketing materials.

The mains, or powerline, filter is the key element in eliminating mains-borne interference. This filter not only has to meet the requirements of electro-magnetic compatibility (EMC), but safety aspects as well. For some applications, the filter also has to prevent the radiation of classified information from the mains line ('Tempest' applications). Other applications require a filter to protect equipment from destructive voltages on the power line, like those caused by lightning or nuclear explosion (NEMP).

Schaffner's breadth of product range, the high attenuation characteristics of our filters under various load conditions, our dedication to quality - and above all our organization's unique experience in filter design and manufacturing - spanning more than 25 years - is your guarantee of excellence.

Total commitment to quality
Schaffner's aim is to provide our customers with fault-free products. To achieve this, 100% of our products undergo rigorous final

testing. To ensure high quality we have instituted a system which meets all the stringent requirements of the ISO 9001 / EN 29001. The phrase 'Quality Assurance' is not just a slogan for us; it is applied in practice, and the Schaffner brand truly stands for reliability and quality.

Schaffner's single-phase filter range provides an off-the-shelf solution for the vast majority of electronic equipment noise problems. Our standard product range is particularly wide, embracing both chassis-mounting and PCB-mounting types, allowing users to select an optimal choice in both performance and cost efficiency terms.

Chassis-mount types

In general, chassis mount filters provide a higher performance solution, in metal cases for optimum connection to earth and good high frequency performance. With the space available for up to three circuit stages for attenuation of noise, users can usually find an option with the performance to provide an off the shelf solution for even the most difficult of EMC problems (to retrofit an EMC solution to an existing design for instance). Schaffner offers chassis-mounting versions for a very wide range of power levels - from less than 1A to 55A - covering a majority of higher power office equipment and low to medium power industrial applications.

At the lower power levels, users have the additional choice of opting for a PCB-

mounting version (see following section), or an IEC inlet type which typically handle currents of up to 6-10A and are ideal for small office and industrial equipment. The associated IEC 950 specification is a key safety requirement for computer and office/business equipment, developed to provide a consistent world standard, which in turn simplifies the certification process. The standard specifies requirements intended to ensure safety against electrical and fire hazards for the operator and layman who may come into contact with the equipment, and where specifically stated, for service personnel. IEC 950-compliance is required for products shipped in Europe, and has either already become - or is in the process of becoming - a de-facto standard in all other world markets. It has been adopted by European countries under EN60950, and by the USA under UL 1950. Two filter families in this catalogue are available with IEC inlets, one of which is compliant with IEC 950 (request separate IEC inlet/IEC 950 catalogue for full details of Schaffner's range).

PCB-mount types

PCB filters are designed for compactness and ease of assembly, and avoid the need for extra mounting components and installation operations necessary with chassis styles, but at the expense of finite available space for filtering circuitry. Consequently, they typically offer just a single stage of attenuation, with limitations on the maximum power handling

capability (up to 6.5A current ratings). This typically makes these filters ideal for those companies who have planned for EMC protection throughout the equipment design process, and are completing equipment protection with these low cost components. When designing these components in, care needs to be taken to provide a low impedance connection to earth, and to minimize the potential for any noise



radiation from the mains inlet connection.

Time to market

The key reasons for choosing ready-made filters are convenience, compactness and cost. Although you can design your own mains inlet and filter using discrete components, or have a custom solution designed and assembled for you, the timescales involved in getting safety approvals will often rule this approach out, especially for higher volume products such as photocopiers which necessitate very fast design cycles.

Ready-made chassis- and PCB-mount filters provide a convenient single-source solution, with the additional benefits of custom-engineered housings for compactness. The following guide to

Schaffner's single-phase products - with brief details on key parameters - will help you to identify one or more filters for closer review of specifications (there are some 170 options available in the total range). From this initial selection, a review of the circuit diagram and detailed specifications in the following pages will tell you if the module is suitable for your application, allowing you to choose a unit (or units) for trial.

Schaffner is one of the world's leading suppliers of EMC equipment, and our extensive experience allows us to offer one of the widest EMC filtering ranges available - spanning both general-purpose and specialist needs like TEMPEST. This breadth of range greatly assists designers, allowing optimum

choices to be made, whether the need is for maximum performance or lowest cost.

Our worldwide organization - with its numerous application engineering teams - will gladly help your engineers select and trial suitable power line filters, and provides an efficient support structure to assist multi-national organizations with dispersed design and manufacturing facilities.

As a review of this catalogue will show you, Schaffner designs power line filters using high grade components in order to optimize reliability. And we construct modules under the control of the most advanced quality system. Whichever power line filter you choose, you can rely on Schaffner's quality.

Schaffner's chassis- and PCB-mounting filter range

Rapid selection Using the current rating and attenuation performance indicators, together with the major features shown on the right, this table allows you to quickly identify a 'short list' of filter families which are potentially suitable for your application, for subsequent detailed investigation using the technical specifications on the following pages.

Filter family	5 10 15 20 25 30 35 40 45 50										with earth line choke	with overvoltage protection	2 stage	3 stage	with IEC inlet	for SMPS	for medical equipment	NEMP, TEMPEST	for printed-circuit mounting	for motor drives		
	1		standard			middle			high		very high											
FN 22	[Current rating: ~5A, Attenuation: ~15-25dB]																				✓	
FN 250, 350	[Current rating: ~10-50A, Attenuation: ~15-40dB]																✓					✓
FN 332	[Current rating: ~5-10A, Attenuation: ~25-35dB]										✓						✓					
FN 343	[Current rating: ~5-10A, Attenuation: ~25-40dB]										✓		✓									
FN 346	[Current rating: ~5-10A, Attenuation: ~25-40dB]														✓	✓						
FN 352Z	[Current rating: ~10-30A, Attenuation: ~15-45dB]										✓		✓		✓							
FN 401 ...406	[Current rating: ~5-15A, Attenuation: ~15-30dB]																✓		✓			
FN 410	[Current rating: ~5-10A, Attenuation: ~25-40dB]												✓						✓			
FN 610, 612	[Current rating: ~5-30A, Attenuation: ~15-30dB]																✓					
FN 660, 670	[Current rating: ~5-20A, Attenuation: ~15-40dB]												✓			✓	✓				✓	
FN 680, 685	[Current rating: ~5-15A, Attenuation: ~25-45dB]												✓			✓					✓	
FN 700Z	[Current rating: ~5-20A, Attenuation: ~25-50dB]										✓			✓	✓	✓		✓				
FN 9675/76	[Current rating: ~5-15A, Attenuation: ~25-45dB]															✓	✓				✓	

Understanding EMC standards and filter specifications

This section introduces the standards and regulations associated with EMC protection, and provides detailed information to help you understand filter design and specifications. It will help you identify for your application the right specifications and type of filter.

Interference protection standards
Until recently most countries have had their own regulations and standards governing electro-magnetic interference (EMI) or radio frequency interference (RFI). However, on the 1 January 1992 the European Directive 89/336/EMC on electro-magnetic compatibility (EMC) came into force. This directive brings a common approach to EMC to every member state of the European Union. Common standards will be used throughout Europe to ensure that technical trade barriers are removed. As well as controlling EMI emissions from equipment, the directive also calls for equipment to be immune to external electro-magnetic disturbances.

The task of elaborating the standards to be used has been given to the European organisation called CENELEC. The member countries of CENELEC are:

Austria	Italy
Belgium	Luxembourg
Denmark	Netherlands
Finland	Norway
France	Portugal
Germany	Spain
Greece	Sweden
Iceland	Switzerland
Ireland	United Kingdom

Most of the European standards will be based upon international standards from CISPR and IEC. The numbering system used in the European standards is:

EN xx yyy

EN = European Norm. xx = 50 denotes that the standard is a standard of CENELEC origin; xx = 55 means the standard is based on a CISPR standard yyy; xx = 60 means the standard is based on an IEC standard yyy.

Once the European standard is complete the individual members of the European Union will produce national harmonised standards and will usually give their harmonised standard a national number, eg the British harmonised standard of EN 55011 is BS EN 55011.

Types of standards:
Basic standards describe the general and fundamental rules for meeting the requirements. Terminology, phenomena, compatibility levels, measurement, test techniques and classification of EM environments are so described within.

Generic standards refer to specific environments. They set minimal EMI levels which equipment in these environments must meet. Where no product specific standards exist then the generic standards are to be used. Generic standards describe household and industrial EMI environments.

Products standards are for specific products or product groups. These standards are coordinated with the generic standards.

In countries outside Europe other standards will be used, such as the FCC in the USA. Table 1 shows the main European standards.

Permissible noise limits

The various standards set down limits for conducted EMI emissions. These limits are measured in voltage and given in dB μ V where 0dB is 1 μ V. The interference is measured using measurement equipment which has defined bandwidths and receivers. The two receivers used are a quasi-peak detector, and an average detector.

To ensure repeatability of the measurements, the impedance of the mains supply must be constant. The standards calls for a defined artificial mains network - sometimes called a line impedance stabilisation network (LISN) - which gives a defined impedance to the noise and also helps filter any noise on the mains which may affect the measurements.

Figure 1 shows the limits of EN 50081-1 the European generic standard for residential, commercial and light industrial environments, and Figure 2 of EN 50081-2, the European generic standard for the industrial environment.

Above 30MHz, radiated noise interference is measured instead of conducted noise. This takes place on an open field test site using defined antennas.

Product type	Emissions			Immunity
	Harmonics	Voltage fluctuations	Radio interference	All aspects
Household appliances & portable tools: vacuum cleaners, washing machines, heating, cooking equipment, dimmers	EN60555-2	EN60555-3	EN55014	EN50082-1
Luminaires with discharge lamps	EN60555-2		EN55015	EN50082-1
TV receivers	EN60555-2		EN55013	EN55020
Information Technology Equipment (ITE)	EN60555-2		EN55022	EN55024 all parts
Mains signalling equipment			EN50065-1	EN50082-2
Industrial, scientific and medical eqpt. designed to generate RF energy			EN55011	EN50082-2
Industrial electronic power and control equipment			EN50081-2	EN50082-2
Industrial non-electronic equipment			EN50081-2 (if producing RF interference)	

Table 1. European EMC standards

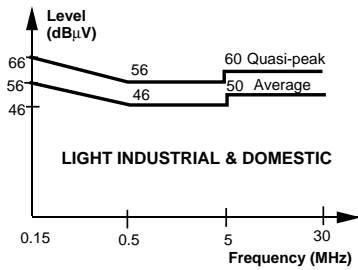

Figure 1. Permissible interference limits for EN 50081-1

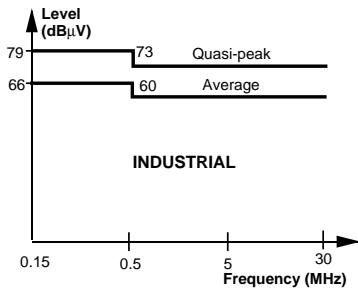

Figure 2. EN 50081-2 limits

Interference sources and spectrums

The most common source of conducted EMI is power electronic products such as switched mode power supplies (SMPS), pulse width modulated (PWM) frequency converters or motor drives, and phase angle controllers.

The emissions spectrum typically starts off very large at low frequency and rolls off as frequency increases. The point at which the noise falls below the permitted limits depends on several factors, the most important being the frequency of operation and the rise time of the semiconductor devices.

Interference spectrums generated can be either continuous, as in the case of phase angle controllers, (Figure 3) or discrete which is typical of the SMPS (Figure 4).

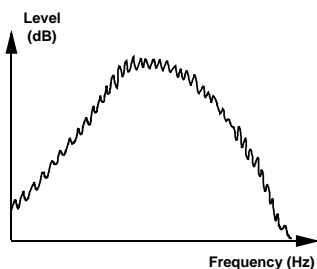

Figure 3. Continuous spectrum

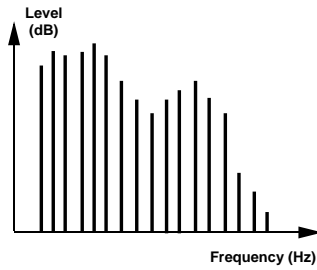

Figure 4. Discrete spectrum

Interference propagation

EMI can propagate by two means:

- by radiation - where the energy can be coupled either through magnetic or electric field, or as an electro-magnetic wave between the source and the victim
- by conduction - where the EMI energy will propagate along power supply lines and data cables

Radiated and conducted EMI cannot be thought of as totally separate problems, because noise conducted along a cable may be radiated as the cable acts as an antenna. The radiation will increase as the cable length becomes comparable to the wavelength of the noise. Also, the cable will act as a receiving antenna and pick up radiated interference.

Below around 150MHz, the most efficient radiating devices in a system are usually the power supply and data cables. Proper filtering of these cables will reduce radiation due to the cables as well as conducted interference.

Above around 150MHz, PCB tracks and short internal cables will start to become efficient antennas. To reduce this radiation a PCB should be laid out to reduce track length and loop areas; ground planes should be used if possible. Decoupling of digital ICs is very important and shielding may be necessary.

Interference types

To understand the problems associated with conducted EMI it is first necessary to understand the two modes of conducted noise: differential mode (or symmetrical mode) and common mode (or asymmetrical mode). Differential mode interference creates a voltage between the phases of the system and is independent of earth; the differential mode currents

flow along one phase and returns along another phase (Figure 5).

Common mode noise creates a voltage between each phase and the earth. The common mode currents flow from the noise source to the earth (usually via a parasitic capacitance) along the earth path and returns along the phases. (See Figure 6) A power line filter must be designed to attenuate both common mode and differential mode interference.

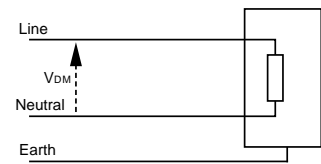

Figure 5. Differential mode interference (V_{DM})

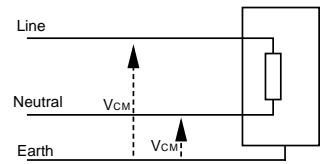

Figure 6. Common mode interference (V_{CM})

Mains filters

Maximum power transfer occurs when source and load impedances are matched. A power line filter is an inductor-capacitor network that aims to cause maximum mismatch between impedances, and therefore reduces the amount of EMI power to be transferred from the noise source onto the power line cable. Figure 7 shows a typical single-phase power line filter.

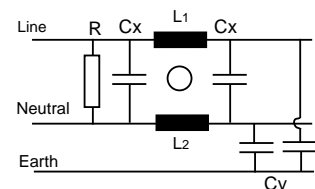

Figure 7. A typical single-phase power line filter

The inductors L1 and 2 are usually wound - in a current compensated fashion - on a toroidal core. This winding method allows flux due to differential mode currents and mains currents to cancel each other, while common mode currents will be added together. This gives a large inductance to common mode currents and ensures that the inductor will not be saturated by the large magnetic flux produced by the mains current.

The capacitors placed between the phases, known as 'X' class capacitors must offer a high pulse voltage rating and are used to attenuate differential mode interference. The capacitors between the phase lines and earth, known as 'Y' class capacitors must have a more stringent rating and are used to attenuate common mode interference. The value of the Y capacitor is restricted by the permissible leakage current allowed. The maximum leakage current is governed by standards and regulations and depends upon the type of equipment. The leakage current is given by:

$$I_L = 2 \cdot \pi \cdot U \cdot f \cdot c$$

where I_L is the leakage current; U the voltage across the capacitor; f the frequency of the mains voltage across the capacitor, and c the capacitance.

Mains filters should be mounted as close as possible to power entry so that high frequency interference does not bypass the filter. IEC inlet modules are ideally suited for this task.

To achieve higher attenuation or an increase in the effective working frequency range more complex filters than the one shown in Figure 7 can be made using more common mode or differential mode inductors and capacitors.

Insertion loss

The insertion loss characteristics for each filter shown on the datasheets, are measured in accordance with CISPR 17. Two test conditions are employed: one using 50Ω termination impedances, the other using an input impedance of 0.1Ω and an output impedance of 100Ω (and reverse conditions). Both test methods can be found in section 4.2 of CISPR 17,

and in 'CISPR 17 Measurements', a document published by Schaffner and available on request.

In the 50Ω test condition, two sets of insertion loss curves are given. One is common (asymmetrical) mode insertion loss. The other one for differential mode interference.

In general, Schaffner filters perform against common mode interference in the manner shown by the 50Ω insertion loss tests. But in differential mode, the 50Ω is not representative of effective performance. Therefore Schaffner includes the 0.1/100Ω differential mode test to show how a filter will perform in real life situations.

For this 0.1/100Ω test condition, only differential mode insertion loss is given. In this test, mismatched impedances illustrate effective filter performance in a piece of equipment.

Both types of insertion loss testing is carried out without load current. In equipment under load, the inductance - and therefore the insertion loss - may change due to saturation. To allow for this Schaffner measures the inductance variation with current. A typical filter has an inductance variation as shown in Figure 8. CISPR17, and/or the application note 'Everything you wanted to know ...' can provide more detailed information.

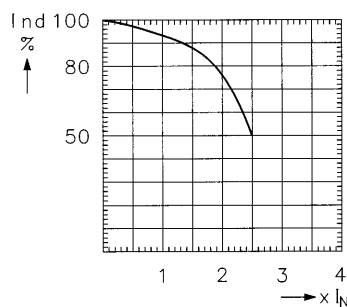

Figure 8. Typical saturation curve

General technical data

All technical data are given at 25°C unless otherwise specified.

Current ratings

The current ratings given for each type is the maximum allowable current authorised by safety agencies at an ambient

temperature of 40°C. Current at other temperatures is shown in the derating curve, or can be ascertained by the formula:

$$I = I_N \sqrt{(85 - \theta)/45}$$

Voltage ratings

The maximum rated voltage is 250V at 50/60Hz unless otherwise stated on the individual datasheets. Use of capacitors within Schaffner filters which conform to IEC 384 - 14 permit operation at voltages of 10% above this value.

High voltage testing

The high voltage rating of our filters is divided into two specifications, one for type testing and one for production testing. This is in accordance with guidelines laid down in various IEC recommendations. Type testing shall be a minimum of 2121 VDC for a minimum of 60 seconds between all terminals. However, the discharge resistor inside the filter shall be removed for this test according to IEC recommendations. All values given in this catalogue are 100% production tests for a minimum of two seconds. Repetition of voltage tests shall not exceed 80% of the specified values.

Leakage current

The leakage current to ground for each type is given as a maximum value per phase, at 230V/50Hz.

Safety approvals Filters in this catalogue are approved by the major world safety approval agencies. Each datasheet indicates the current safety approval status. The relevant file numbers for our filters are:

UL E64388 Test: UL 1283

CSA LR 44788 Test: CSA 22.2
No. 8-M1986

SEV Test: IEC 939

VDE 7226-4730-10.. Test: VDE 0565-3

SEMKO Test: IEC 939

Almost all of the filters in this catalogue meet the requirements of IEC 950 for Class I and Class III installations with Basic and Supplementary Insulation. For further information see Schaffner's application note 'IEC 950'.

Flammability class All filters in this catalogue are UL 94V2 or UL94V0.

MTBF figures In addition to safety approvals, Schaffner filters also have the high reliability shown in the MTBF (mean time between failure) values given for each filter family. This is the lowest typical value for any filter in the particular family and is calculated according to Mil-HB 217-F, for maximum rated current and voltage in an ambient temperature of 40°C. MTBF is stated in hours.

Components The component values given in the detailed product pages are nominal. The value of inductors and capacitors can vary from this nominal value. The tolerance and test conditions for these components is shown in the following table:

Parameter	- Tol.	+ Tol.	Test
Inductance	30%	50%	1kHz
Capacitance	20%	20%	1kHz
Resistance	10%	10%	DC

Climatic classification Schaffner filters fulfil the requirements of the HPF climatic classification according to DIN 40040 (ambient temperature -25 to +85°C).

Filters with a connecting cable - such as types FN 0.8 to FN 20 meet the requirements of the HSF climatic classification (ambient temperature -25 to +70°C).

The letters of the climatic classification are coded as follows:

- 1st letter: Lower temperature limit:
H ≅ -25°C
- 2nd letter: Upper temperature limit:
S ≅ +70°C P ≅ +85°C
- 3rd letter: Permissible humidity (relative):
F ≅ 75% yearly average
95% highest value for 30 days
85% highest for all other days

According DIN IEC 68 Part 1, the climatic category is given by three numbers, separated by /

Sample: 25/085/21

- 1st number: Lower temperature limit:
-25°C
- 2nd number: Upper temperature limit:
+85°C

3rd number: Humidity, 90-95% R.H.
21 days

Filters with a greater temperature range, for special applications and for military use, are available on request.

Filters with earth line chokes
It is possible to get interference induced on all cables of a system simultaneously. In this case the same noise will also be induced onto the earth cable. A standard filter will reduce the noise on the phase lines but not on the earth. The noise on the earth line will then be able to enter the equipment and may cause the equipment to malfunction. To reduce this interference earth line chokes may be fitted or incorporated into the filter. The earth line choke will also provide extra attenuation for normal common mode currents.

Care must be taken not to bypass earth line chokes in systems. For example a PC may have a filter with an earth line choke fitted, if this PC is connected to a printer that is powered from the mains supply, and if the printer does not have an earth line choke, the noise may find a path from the mains into the printer and along the data cable into the PC bypassing the earth line choke in the PC.

Filters for medical equipment
For enhanced safety in medical applications, Schaffner offers 'B' versions of many of its filters, offering lower leakage current (3µA typical), a discharge resistor, and higher potential test values (for example FN 326B).

Special filters for NEMP
A nuclear electro-magnetic pulse (NEMP) is a high intensity, short duration, electro-magnetic field produced as a result of a nuclear explosion outside the atmosphere (exo-atmospheric). The most critical threat for technically highly developed nations is an exo-atmospheric burst (at an altitude of more than 40 km) producing a NEMP inducing in antennas, power transmission networks etc, such high voltages and currents that it may leave a whole continent without power, telephone or radio communications. Electronic equipment can be protected against a NEMP if it is placed in special room or housing which screen it from the electro-

magnetic fields, and if all feed lines to these areas are protected with voltage limiting devices such as varistors, gas discharge tubes and suppressor diodes.

Special filters for TEMPEST
Telecommunication or data processing equipment can radiate signals, or propagate them along power lines, providing a mechanism for unauthorised persons to access classified information. The study and blocking of such sensitive signals is known as TEMPEST. Mains filters with high attenuation over a large frequency range are necessary. An optimum filter solution can only be found by an exact specification of requirements. The FN 700Z filter series has been used in many TEMPEST applications. Other suitable filters are available on request.

Customer-specific filters
Schaffner's standard range of filters cover the majority of customers' requirements. But depending on the application, specific criteria might need to be considered. With our many years of experience, as well as the flexibility and capability of our five development centers located throughout the world, Schaffner can offer companies an efficient and reliable custom engineering service. To date, Schaffner has produced over 4000 custom filters, ranging from 0.1 amps up to 1200 amps, from a matchbox size to rack mount designs, with up to 23 input connections, used in all forms of environments from offices to submarines to factories to military armoured vehicles.

EMC measurement and engineering services

In addition to offering one of the world's most comprehensive ranges of standard filter products, Schaffner offers the full complement of measurement and engineering services to support equipment manufacturers and users.

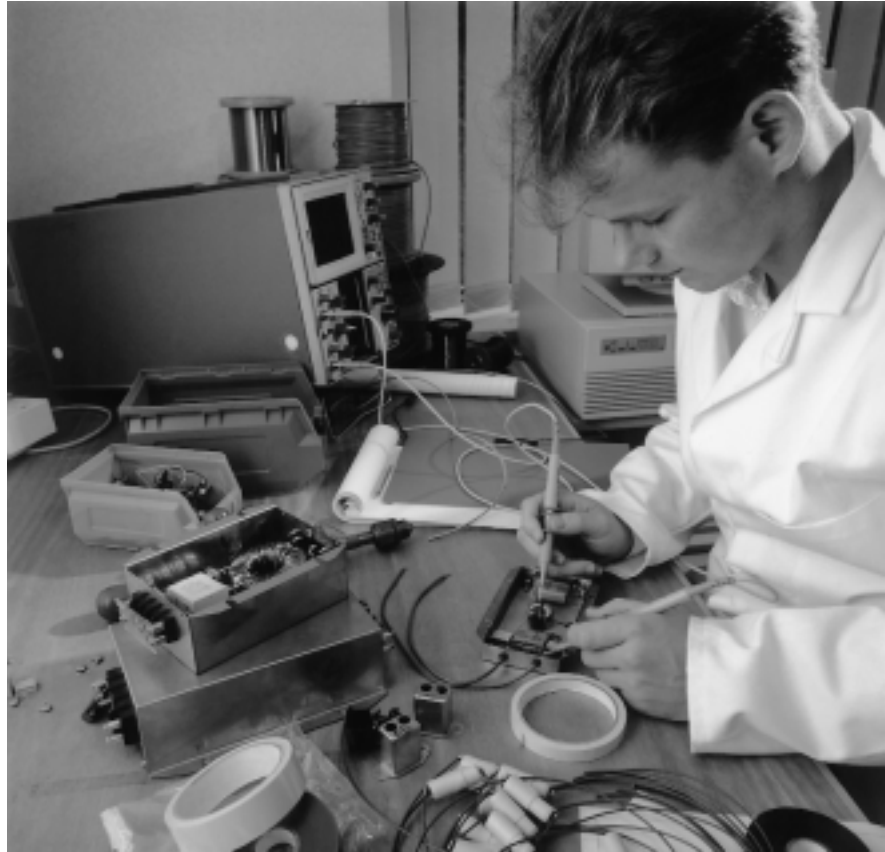

EMC testing

Schaffner operates the most sophisticated EMC test facilities available anywhere today - with extensive investment in screened rooms, specialist test equipment, and application engineering teams - distributed at seven locations throughout the world. Services available at these locations include:

- Faraday cage and open field testing
- harmonics instrumentation for current and voltage to the 49th harmonic
- radio emission measurements to CISPR, EN, VDE, FCC, Mil or SEV
- simulation of electro-magnetic fields
- simulation of short-term DC or AC mains failures
- simulation of transient parasitic voltages
- electro-static discharges to IEC 801-2, VDE 0843 part 2 specifications
- AC and DC insulation testing

Engineering services

Schaffner has the largest world engineering experience in solving EMC problems. In addition to testing and measuring services Schaffner can provide the expert engineering support to help you bring your equipment to market quickly and efficiently; services available include:

- custom filter design
 - to optimize filter performance, and solve space, layout, mounting or connection problems
- circuit and equipment design
 - advising on circuit and equipment or enclosure design to overcome EMC problems
- turnkey component design and build

Ordering information

For all single-phase filters (except FN 22)

FN 250 & - x / y

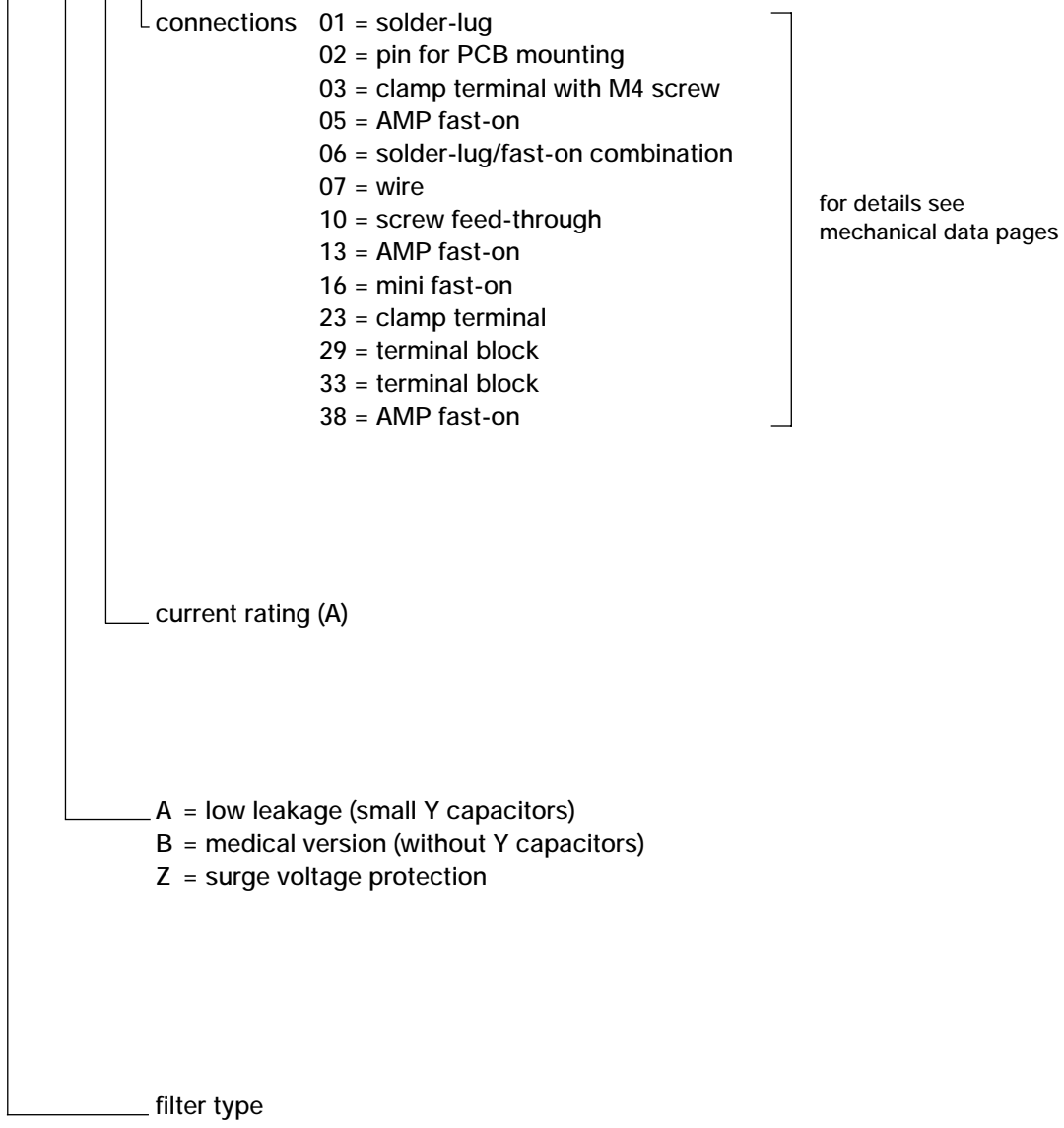

Examples:

FN 670-1.8/07 Type FN 670; current rating 1.8A; with wire connections

FN 350-55/33 Type FN 350; current rating 55A; with safety terminal block connections

Compact PCB-mounting filter

Provided in a compact plastic housing suitable for use with automatic assembly equipment, this PCB-mounting filter offers good basic performance, with a profile which suits equipment designs such as monitors, terminals and power supplies.

- compact PCB-mounting design
- auto-insertion machine friendly



See Mechanical Data (pages 59 and 60) for full details of housings and connections.

Filter selection table

Choose the family **FN xxx** with the required current rating and features, and add **/2** or **/3** to determine the component value.

Approvals



Family	Connections I	Current ratings		Capacitance		Inductance L mH	Housing	Weight g
		A at 40°C (25°)		Cx nF	Cy nF			
FN 22 -0.8 /2	✓	0.8	(0.95)	47	2.2	10	KA1	30
FN 22 -0.8 /3	✓	0.8	(0.95)	15	2.2	0.3	KA1	30

Additional specifications

Filter type	Maximum leakage µA/phase	Maximum operating voltage		Operating frequency Hz	Hipot test voltage	
		VAC	Hz		PN→E VAC	P→N VDC
Standard types	190	250	50/60	DC to 400	2000	1700

MTBF at 40°C, 230V, per Mil-HB-217F: 2,750,000 hours.

Insertion loss

Per CISPR 17; A = 50Ω/50Ω sym, B = 50Ω/50Ω asym, C = 0.1Ω/100Ω sym, D = 100Ω/0.1Ω sym

FN 22-0.8/2 types

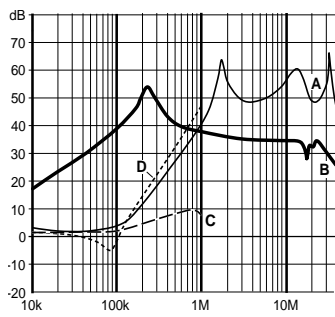

FN 22-0.8/3 types

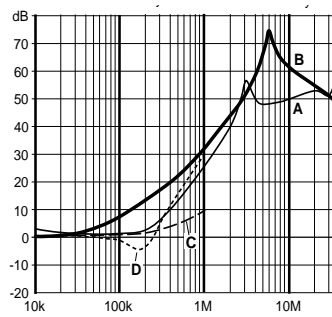

Electrical schematics

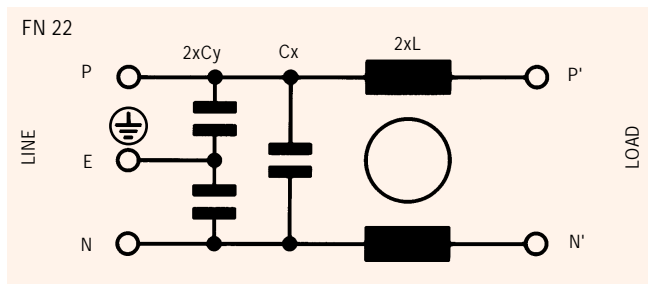

See tables for component values.

FN 250

Input filter for motor drives

High inductance and capacitance values optimized for common mode attenuation in the 0.1-1MHz range make this filter ideal for a large variety of motor drive applications. Long wire connections give great installation flexibility, simplifying assembly for drive manufacturers.

- 6 to 20A current ratings
- compact housings with long wire connections
- meets EN55011(A) for drives with motor cables <20m



See Mechanical Data (pages 58 and 60) for full details of housings and connections.

Filter selection table

Choose the family **FN xxx** with the required current rating and features, and add */??* to determine input/output (line/load) connection style. Example: FN 250-6/07 is a 6A filter with wire connections.

Approvals



Family	Connections 	Current ratings		Capacitance		Res. R MΩ	Power loss W	Inductance L mH	Housing	Weight g
		A at 40°C (25°)		Cx/Cx1 μF	Cy nF					
FN 250 -6 <i> /??</i>	<i> /07</i>	6	(6.9)	0.47/0.47	15	0.47	2.5	5.7	K11	240
FN 250 -12 <i> /??</i>	<i> /07</i>	12	(13.8)	1/1	15	0.47	6	2.7	K22	310
FN 250 -20 <i> /??</i>	<i> /07</i>	20	(23)	2.2/2	15	0.22	8	1.9	L4	600

Additional specifications

Filter type	Maximum leakage μA/phase	Maximum operating voltage		Operating frequency Hz	Hipot test voltage	
		VAC	Hz		PN→E VAC	P→N VDC
Standard types	1300	250	50/60	DC to 400	2000	1100

MTBF at 40°C, 230V, per Mil-HB-217F: 295,000 hours.

Insertion loss

Per CISPR 17; A = 50Ω/50Ω sym, B = 50Ω/50Ω asym, C = 0.1Ω/100Ω sym, D = 100Ω/0.1Ω sym

6 amp types

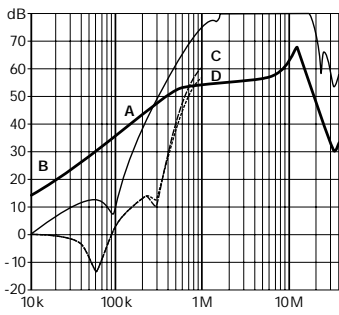

12 amp types

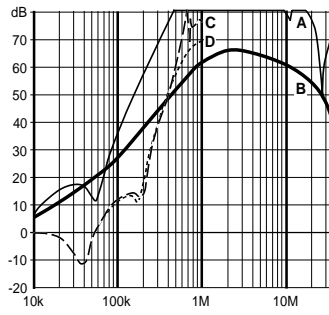

20 amp types

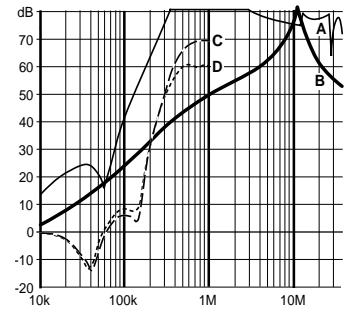

Electrical schematics

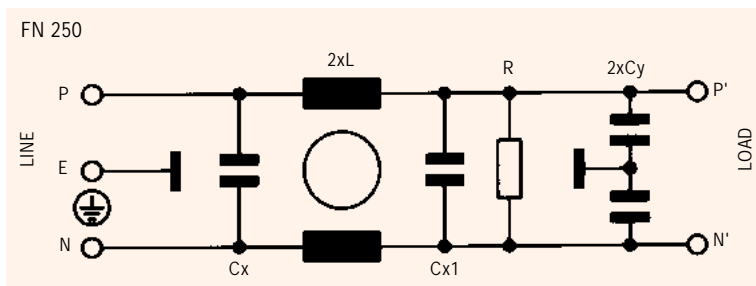

See tables for component values.

FN 332

Performance filter

Designed for suppressing high interference levels, this filter is available in a wide choice of current ratings, and also in an optional Z version with a varistor for protection against high surge voltages.

- 1 to 10A current ratings
- compact housing with solder or fast-on connections
- optional surge voltage protection (Z types)





See Mechanical Data (pages 57 and 60) for full details of housings and connections.

Filter selection table

Choose the family **FN xxx** with the required current rating and features, and add *1??* to determine input/output (line/load) connection style. Example: FN 332-6/01 is a 6A filter with solder lug connections.

Approvals



Family	Connections		Current ratings		Inductance L mH	Housing	Weight g
			A at 40°C (25°)				
FN 332 -1 1??	/01	/05	1	(1.2)	10	G1	65
FN 332 -3 1??	/01	/05	3	(3.6)	2	G1	65
FN 332 -6 1??	/01	/05	6	(7.3)	0.8	G1	65
FN 332 -10A/??	/01	/05	10	(12)	0.5	G1	70

Additional specifications

Filter type	Capacitance		Surge current A	Energy absorption J	Maximum leakage μA/phase	Maximum operating voltage		Operating frequency Hz	Hipot test voltage	
	Cx nF	Cy nF				VAC	Hz		PN→E VAC	P→N VDC
Standard types	15	2.2	-	-	190	250	50/60	DC to 400	2000	1700
FN 332Z types (surge protected)	15	2.2	1200	26	190	250	50/60	DC to 400	2000	350

MTBF at 40°C, 230V, per Mil-HB-217F: 710,000 hours.

FN 343

Two-stage filter

A general-purpose filter with a two-stage design and integral earth line choke for high performance with good common mode attenuation.

- 1 to 10A current ratings
- 2-stage design with earth line choke





See Mechanical Data (pages 57 and 60) for full details of housings and connections.

Filter selection table

Choose the family **FN xxx** with the required current rating and features, and add *???* to determine input/output (line/load) connection style. Example: FN 343-3/01 is a 3A filter with solder lug connections.

Approvals



Family	Connections		Current ratings		Inductance L/L ₁ /L ₂ mH	Housing	Weight g
			A at 40°C (25°)				
FN 343 -1 <i>???</i>	/01	/05	1	(1.15)	5.6/10/0.4	J2	160
FN 343 -3 <i>???</i>	/01	/05	3	(3.4)	1.1/2/0.4	J2	160
FN 343 -6 <i>???</i>	/01	/05	6	(6.9)	0.43/0.77/0.4	J2	160
FN 343 -10 <i>???</i>	/01	/05	10	(11.5)	0.27/0.66/0.4	J2	170

Additional specifications

Filter type	Capacitance		Res. R MΩ	Maximum leakage μA/phase	Maximum operating voltage		Operating frequency Hz	Hipot test voltage	
	C _x /C _{x1} nF	C _y nF			VAC	Hz		PN→E VAC	P→N VAC
Standard types	100/100	2.2	1	190	250	50/60	DC to 400	2000	1700

MTBF at 40°C, 230V, per Mil-HB-217F: 970,000 hours.

Insertion loss

Per CISPR 17; A = 50Ω/50Ω sym, B = 50Ω/50Ω asym, C = 0.1Ω/100Ω sym, D = 100Ω/0.1Ω sym

1 amp types

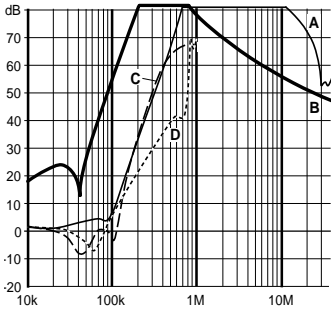

3 amp types

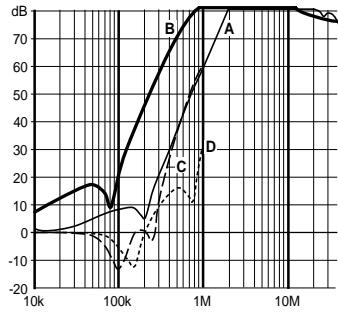

6 amp types

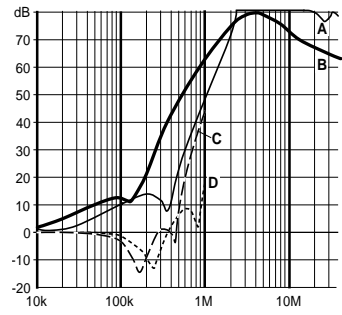

10 amp types

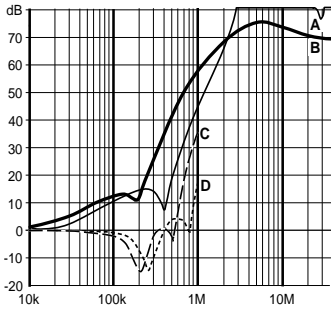

Electrical schematics

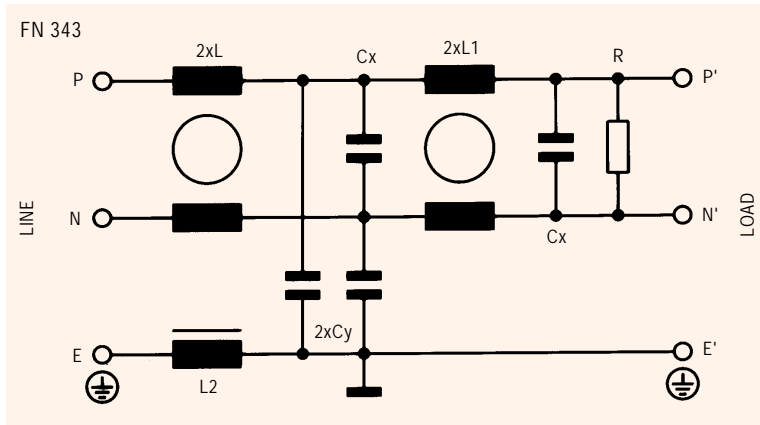

See tables for component values.

FN 346

High-performance filter

This filter offers IEC 320-compliant power entry with excellent filtering performance thanks to the use of a U-core plus large inductor and capacitor components. Very high symmetrical attenuation makes the filter an ideal choice for switched-mode power supply equipment applications, and any other form of circuitry involving non-sinusoidal waveforms.



See Mechanical Data (pages 56 and 60) for full details of housings and connections.

- up to 10A current ratings
- very high performance filtering
- optional medical versions (B types)

Filter selection table

Choose the family **FN xxx** with the required current rating and features, and add *??* to determine input/output (line/load) connection style. Example: FN 346-10/06 is a 10A filter with fast-on connections.

Approvals



Family	Connections 	Current ratings		Inductance L mH	Housing	Weight g
		A at 40°C (25°)				
FN 346 -1.6 <i>???</i>	/06	1.6	(1.9)	34	B27	330
FN 346 -2.5 <i>???</i>	/06	2.5	(3)	18	B27	330
FN 346 -6 <i>???</i>	/06	6	(7.3)	3	B27	330
FN 346 -10 <i>???</i>	/06	10	(12)	0.7	B27	330

Additional specifications

Filter type	Capacitance		Res. R MΩ	Maximum leakage μA/phase	Maximum operating voltage		Operating frequency Hz	Hipot test voltage	
	Cx/Cx ₁ nF	Cy nF			VAC	Hz		PN→E VAC	P→N VDC
Standard types	470/220	4.7	0.47	410	250	50/60	DC to 400	2000	1700
B types (medical)	470/220	-	0.47	5	250	50/60	DC to 400	2000	1700

MTBF at 40°C, 230V, per Mil-HB-217F: 330,000 hours.

Insertion loss

Per CISPR 17; A = 50Ω/50Ω sym, B = 50Ω/50Ω asym, C = 0.1Ω/100Ω sym, D = 100Ω/0.1Ω sym

1.6 amp types

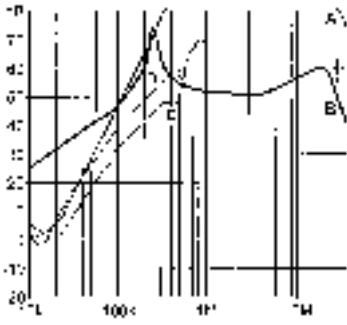

2.5 amp types

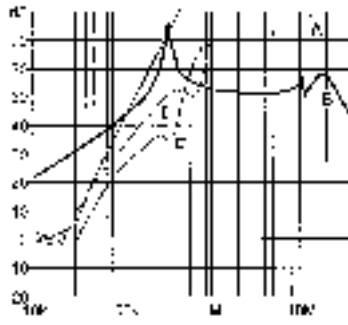

6 amp types

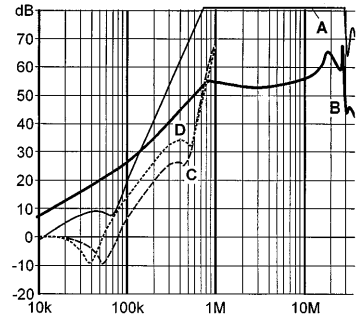

10 amp types

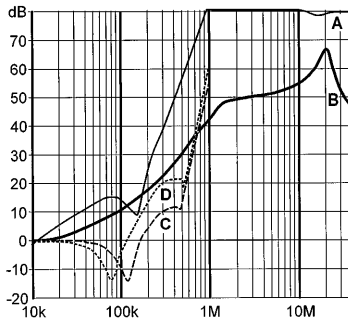

Electrical schematics

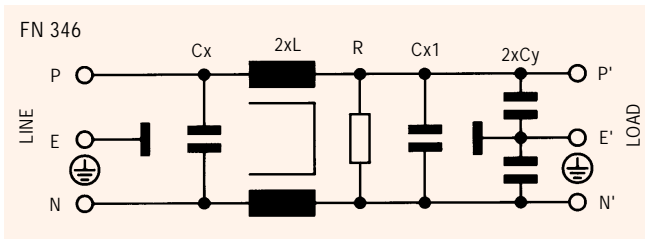

See tables for component values.

High power filter for drives

High inductance and capacitance values optimized for common and differential mode attenuation in the lower frequency range make this filter ideal for a large variety of motor drive applications. Supplied in a relatively small footprint design with terminal blocks for easy installation and servicing in industrial environments; also meets IEC 950 extending applications flexibility.



See Mechanical Data (pages 55, 58 and 60) for full details of housings and connections.



- 8 to 55A current ratings
- screwdriver-connect terminations
- meets EN55011/14/22 VDE 0871/75/78
- meets IEC 950

Filter selection table

Choose the family **FN xxx** with the required current rating and features, and add **/??** to determine input/output (line/load) connection style. Example: FN 350-55/33 is a 55A filter with terminal connections suitable for AWG 6/16mm² wire.

Approvals



Family	Connections		Current ratings		Capacitance		Inductance L mH	Maximum leakage μA/phase	Power loss W	Housing	Weight g
			A at 40°C (25°)		Cx/Cx1 μF	Cy/Cy1 nF					
FN 350 -8 /??	/29	-	8	(9.2)	2/0.68	10/47	10	4900	4.2	L21	700
FN 350 -12 /??	/29	-	12	(13.8)	2.2/1	10/47	7.5	4900	5.2	L21	900
FN 350 -20 /??	/29	-	20	(23)	2.2/1	10/47	3.2	4900	5.7	L21	950
FN 350 -30 /??	-	/33	30	(34.5)	2.2/1	15/47	1.3	5300	5.9	L21	950
FN 350 -55 /??	-	/33	55	(63)	4.4/1	33/94	1	11 000	8.2	B21	1800

Additional specifications

Filter type	Res R MΩ	Maximum operating voltage		Operating frequency Hz	Hipot test voltage	
		VAC	Hz		PN→E VDC	P→N VDC
Standard types	1	250	50/60	DC to 60	2800	1700

MTBF at 40°C, 230V, per Mil-HB-217F: 420,000 hours.

Insertion loss

Per CISPR 17; A = $50\Omega/50\Omega$ sym, B = $50\Omega/50\Omega$ asym, C = $0.1\Omega/100\Omega$ sym, D = $100\Omega/0.1\Omega$ sym

8 amp types

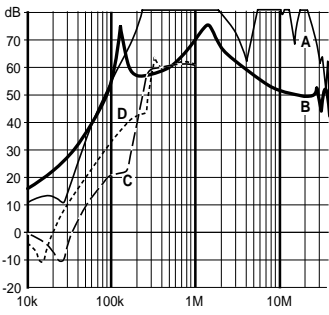

12 amp types

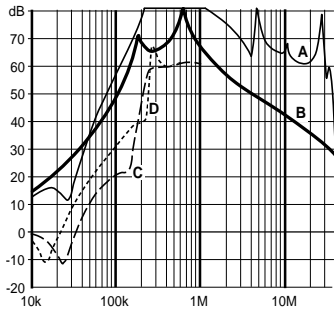

20 amp types

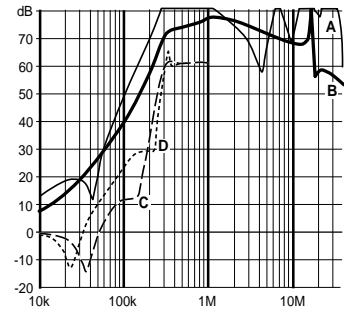

30 amp types

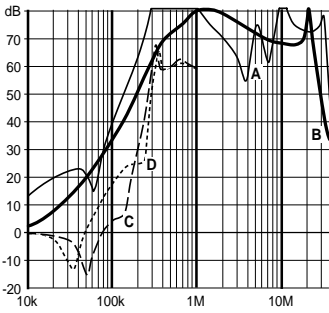

55 amp types

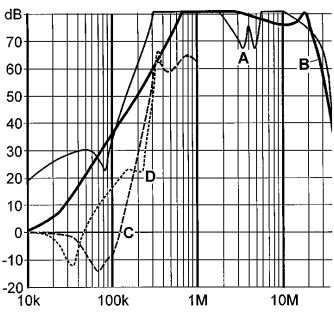

Electrical schematics

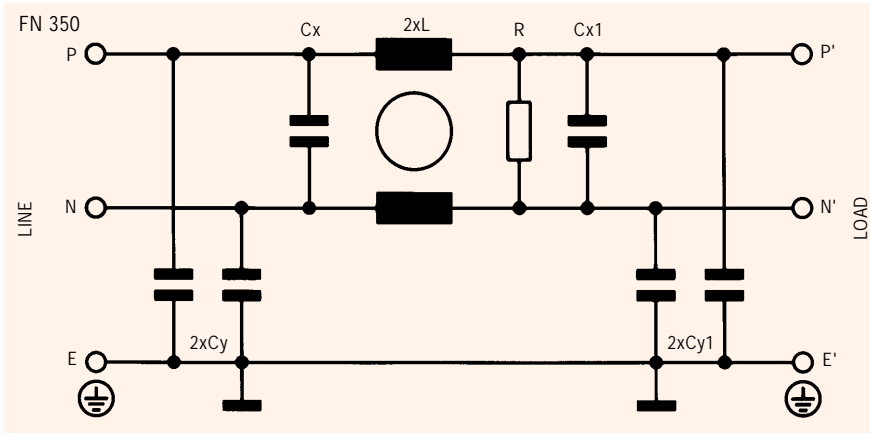

See tables for component values.

FN 352Z

Multi-stage filter

This filter family provides a high performance two- or three-stage circuit design with a varistor for protection against high surge voltages of up to 2000A. The 353Z version packages the same circuit design around a differential mode core for greater compactness.



See Mechanical Data (pages 55 and 60) for full details of housings and connections.



- 6 to 30A current ratings
- integral surge voltage protection to 2kA
- solder or screwdriver connections

Filter selection table

Choose the family **FN xxx** with the required current rating and features, and add *???* to determine input/output (line/load) connection style. Example: FN 352Z-6/06 is a 6A filter with fast-on connections.

Approvals



Family	Connections		Current ratings A at 40°C (25°)	Capacitance Cx/Cx1 nF Cy/Cy1 nF		Res. R MΩ	Inductance L/L1/L2 mH	Maximum leakage μA/phase	Housing	Weight g
										
FN 352Z -6 /??	/06	-	6 (7.2)	470/220	3.3/1.5	0.47	3/3/-	420	B22	575
FN 352Z -10 /??	-	/29	10 (12)	220/220	15/15	0.47	5/0.06/0.003	1300	B8	1320
FN 352Z -20 /??	-	/29	16 (20)	220/220	15/15	0.47	3.5/0.06/0.0035	1300	B13	2950
FN 353Z -30 /??	-	/33	24 (30)	470/220	15/15	0.23	2.3/0.025/0.035	1300	B13	3100

Additional specifications

Filter type	Energy absorption J	Maximum operating voltage		Operating frequency Hz	Hipot test voltage	
		VAC	Hz		PN→E VAC	P→N VDC
Standard types	40	250	50/60	DC to 400	2000	350

MTBF at 40°C, 230V, per Mil-HB-217F: 230,000 hours.

Insertion loss

Per CISPR 17; A = 50Ω/50Ω sym, B = 50Ω/50Ω asym, C = 0.1Ω/100Ω sym, D = 100Ω/0.1Ω sym

6 amp types

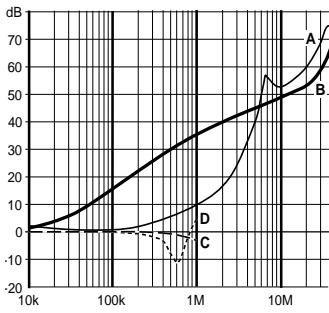

10 amp types

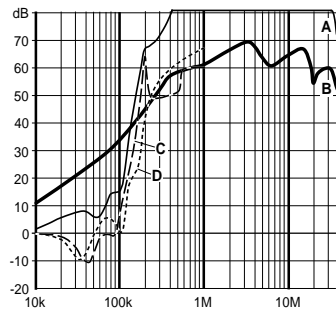

20 amp types

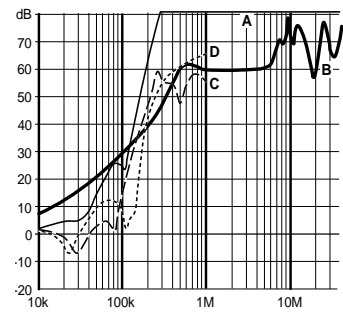

30 amp types

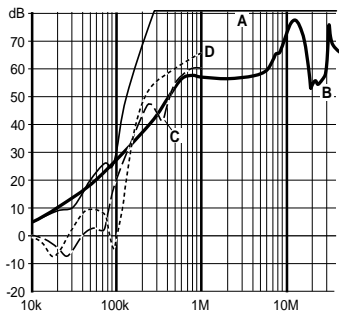

Electrical schematics

FN 352Z-6

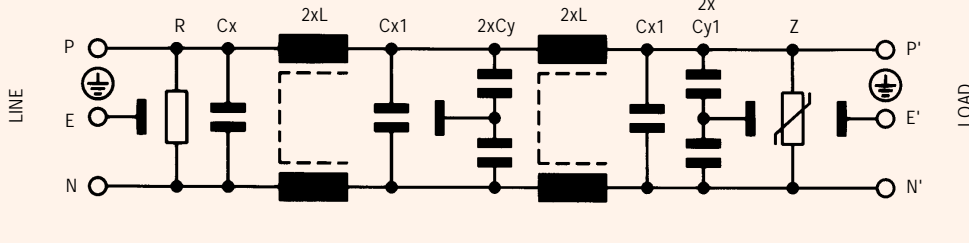

FN 352Z-10/FN 352Z-20/FN 353Z-30

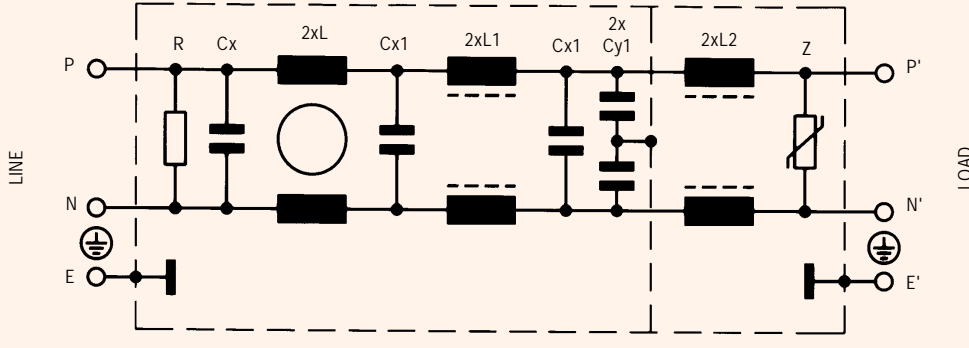

See tables for component values.

Two-stage filter for motor drives

This two-stage filter offers good low-to-medium power performance aimed at the frequency ranges encountered in typical motor drive applications, and also lower frequency (sub 100kHz) equipment. Terminal blocks simplify installation and servicing.



See Mechanical Data (pages 55 and 60) for full details of housings and connections.

- 6 to 16A current ratings
- screwdriver-connect terminations
- meets EN55011/14/22 VDE 0871/75/78

Filter selection table

Choose the family **FN xxx** with the required current rating and features, and add **/??** to determine input/output (line/load) connection style. Example: FN 357-10/29 is a 10A filter with terminal connections suitable for AWG 10/6mm² wire.

Approvals



Family	Connections 	Current ratings		Capacitance		Res. R MΩ	Inductance L/L ₁ mH	Maximum leakage μA/phase	Power loss W	Housing	Weight g
		A at 40°C (25°)		C _x /C _{x1} μF	C _y /C _{y1} nF						
FN 357 -6 /??	/29	6 (6.9)		1.5/2.2	22/-	0.1	3.5/0.75	3800	5.5	B7	1450
FN 357 -10 /??	/29	10 (11.5)		2.2/2.2	22/33	0.1	2.8/0.45	4800	6.2	B7	1500
FN 357 -16 /??	/29	16 (18.4)		3/3	47/47	0.075	2.3/0.4	8100	8.4	B11	3000

Additional specifications

Filter type	Maximum operating voltage		Operating frequency Hz	Hipot test voltage	
	VAC	Hz		PN→E VDC	P→N VDC
Standard types	250	50/60	DC to 60	2800	1100

MTBF at 40°C, 230V, per Mil-HB-217F: 250,000 hours.

Insertion loss

Per CISPR 17; A = 50Ω/50Ω sym, B = 50Ω/50Ω asym, C = 0.1Ω/100Ω sym, D = 100Ω/0.1Ω sym

6 amp types

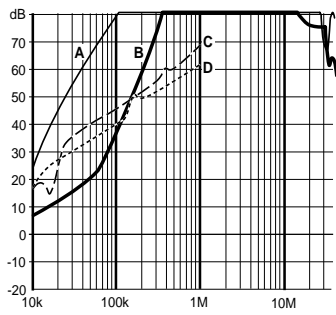

10 amp types

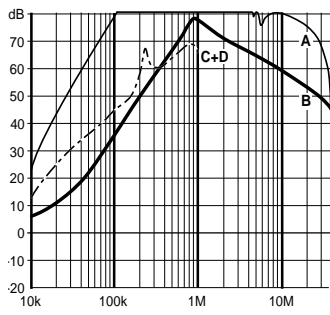

16 amp types

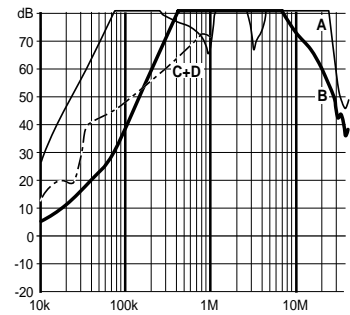

Electrical schematics

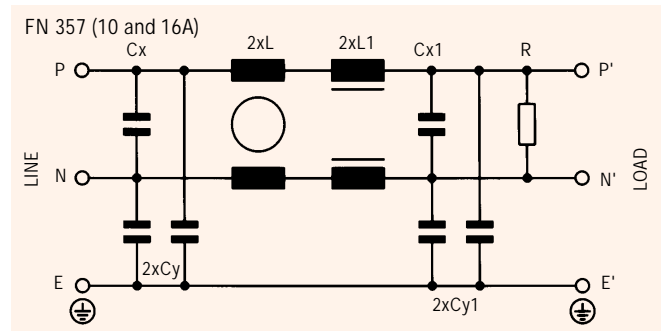
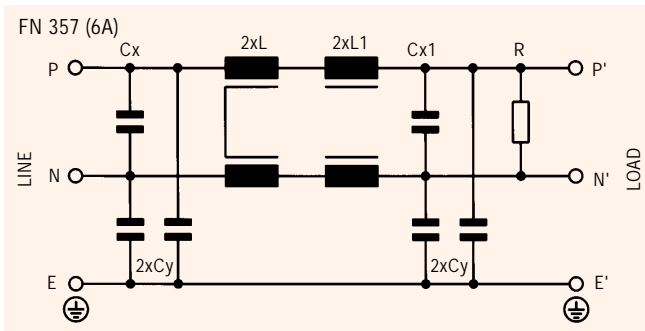

See tables for component values.

Performance PCB-mount filter

FN 401

Offering excellent filtering with high component values for good asymmetric and common mode attenuation, suitable for demanding applications such as switched-mode power supplies, this filter is supplied in a low-profile plastic PCB-mount package in a choice of two low power ratings.



- 0.8-1.5A current ratings
- compact PCB-mount footprint
- low profile design

See Mechanical Data (pages 59 and 60) for full details of housings and connections.

Filter selection table

Choose the family **FN xxx** with the required current rating and features, and add */??* to determine input/output (line/load) connection style. Example: FN 401-1.5/02 is a 1.5A filter with pin connections.

Approvals



Family	Connections 	Current ratings		Capacitance			Res. R MΩ	Inductance L mH	Housing	Weight g
		A at 40°C (25°)		Cx nF	Cx1 nF	Cy nF				
FN 401 -0.8 /??	/02	0.8	(0.95)	68	15	2.2	-	20	KA2	30
FN 401 -1.5 /??	/02	1.5	(1.8)	100	-	2.2	1	20	KA3	90

Additional specifications

Filter type	Maximum leakage μA/phase	Maximum operating voltage		Operating frequency Hz	Hipot test voltage	
		VAC	Hz		PN→E VAC	P→N VDC
Standard types	190	250	50/60	DC to 400	2000	1100

MTBF at 40°C, 230V, per Mil-HB-217F: 1,000,000 hours.

Insertion loss

Per CISPR 17; A = 50Ω/50Ω sym, B = 50Ω/50Ω asym, C = 0.1Ω/100Ω sym, D = 100Ω/0.1Ω sym

0.8 amp types

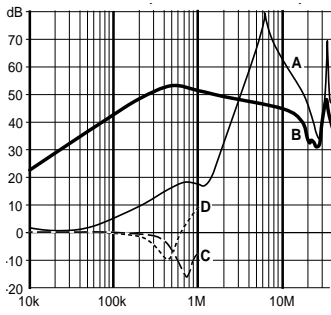

1.5 amp types

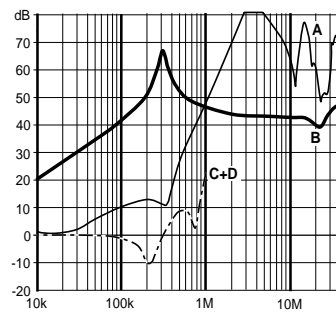

Electrical schematics

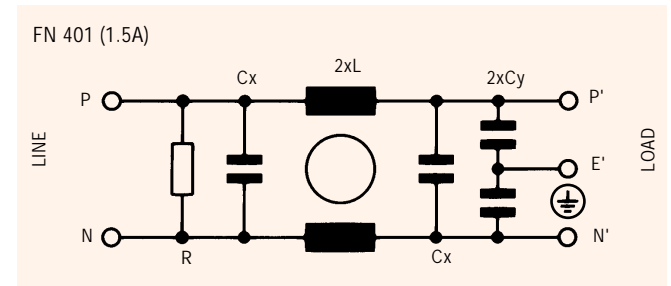
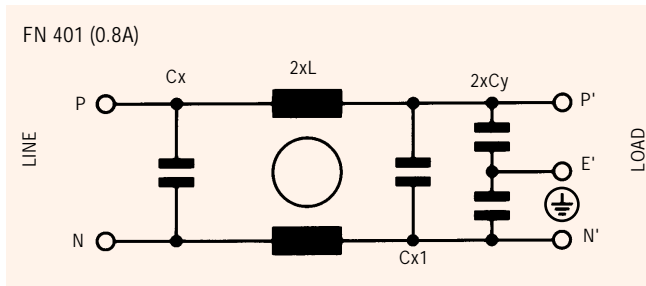

See tables for component values.

Low-cost PCB/chassis-mount filter FN 402

Provided in a very compact and low profile PCB- or chassis-mounting plastic enclosure, with a choice of six current ratings and four output connections, this filter combines great versatility with economy.

- 0.5-6.5A current ratings
- compact PCB- or chassis-mountable design
- four connection style choices
- very low profile
- optional medical versions (B types)



See Mechanical Data (pages 59 and 60) for full details of housings and connections.

Filter selection table

Choose the family **FN xxx** with the required current rating and features, and add *1??* to determine input/output (line/load) connection style. Example: FN 402-4/16 is a 4A filter with mini fast-on connections.

Approvals



Family	Connections				Current ratings A at 40°C (25°)	Inductance L mH	Housing	Weight g
FN 402 -0.5 <i>1??</i>	/02	/07*	/16	/38	0.5 (0.6)	40	KA/KB	40
FN 402 -1 <i>1??</i>	/02	/07*	/16	/38	1 (1.2)	10	KA/KB	40
FN 402 -1.6 <i>1??</i>	/02	/07*	/16	/38	1.6 (1.9)	6	KA/KB	40
FN 402 -2.5 <i>1??</i>	/02	/07*	/16	/38	2.5 (3.0)	2	KA/KB	40
FN 402 -4 <i>1??</i>	/02	/07*	/16	/38	4 (4.7)	1	KA/KB	40
FN 402 -6.5 <i>1??</i>	/02	/07*	/16	/38	6.5 (7.5)	1	KA/KB	40

* /07 outputs add 5g to weight

Additional specifications

Filter type	Capacitance		Res. R MΩ	Maximum leakage μA/phase	Maximum operating voltage		Operating frequency Hz	Hipot test voltage	
	Cx nF	Cy nF			VAC	Hz		PN→E VAC	P→N VDC
Standard types	100	2.2	1	190	250	50/60	DC to 400	2000	1700
B types (medical)	100	-	1	2	250	50/60	DC to 400	2500	1700

MTBF at 40°C, 230V, per Mil-HB-217F: 1,900,000 hours. (standard types); 1,200,000 hours (B types)

Insertion loss

Per CISPR 17; A = 50Ω/50Ω sym, B = 50Ω/50Ω asym, C = 0.1Ω/100Ω sym, D = 100Ω/0.1Ω sym

0.5 amp types

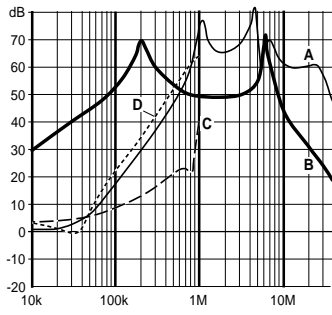

1 amp types

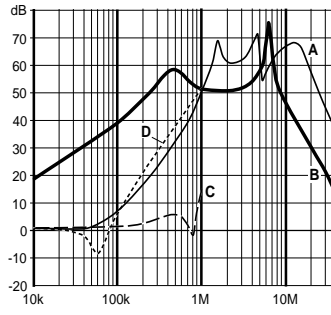

1.6 amp types

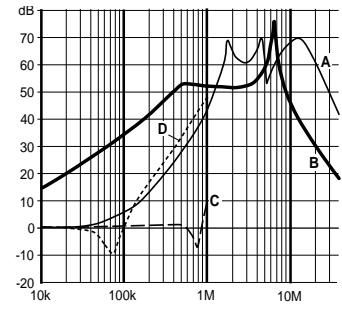

2.5 amp types

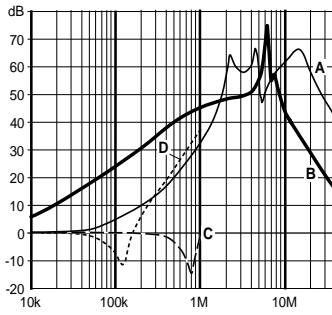

4 amp types

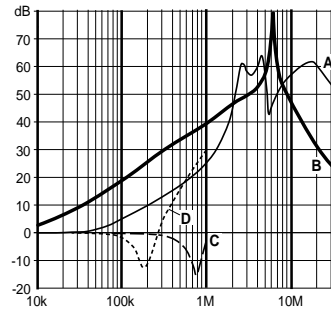

6.5 amp types

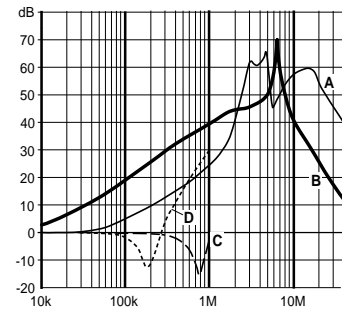

Electrical schematics

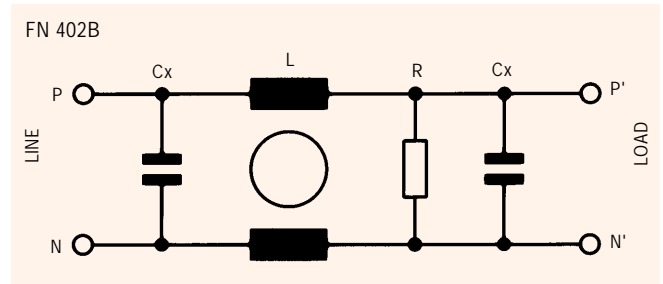
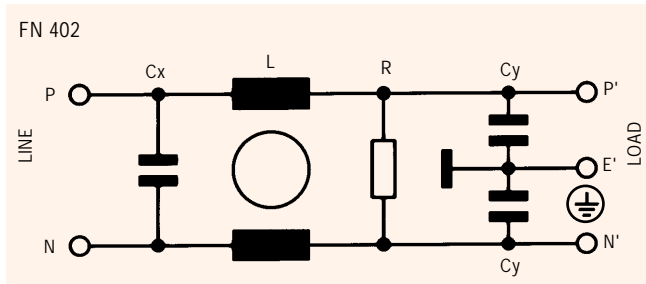

See tables for component values.

FN 405

PCB-mounting filter

General-purpose filter for PCB mounting applications, supplied in a plastic housing.

- 0.5-6A current ratings
- PCB-mounting
- low profile

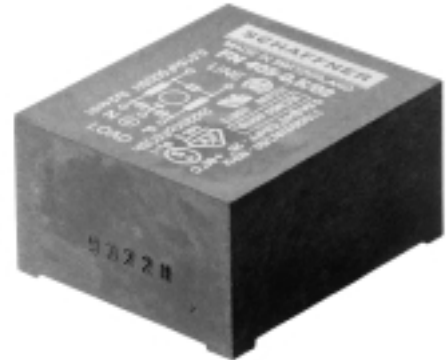

See Mechanical Data (pages 59 and 60) for full details of housings and connections.

Filter selection table

Choose the family **FN xxx** with the required current rating and features, and add */??* to determine input/output (line/load) connection style. Example: FN 405-6/02 is a 6A filter with pin connections.

Approvals



Family	Connections I	Current ratings A at 40°C (25°)	Inductance L mH	Housing	Weight g
FN 405 -0.5 /??	/02	0.5 (0.6)	24	KA4	40
FN 405 -1 /??	/02	1 (1.2)	10	KA4	40
FN 405 -3 /??	/02	3 (3.6)	2	KA4	40
FN 405 -6 /??	/02	6 (6.9)	0.8	KA4	40

Additional specifications

Filter type	Capacitance		Maximum leakage μA/phase	Maximum operating voltage		Operating frequency Hz	Hipot test voltage	
	Cx nF	Cy nF		VAC	Hz		PN→E VAC	P→N VDC
Standard types	15	2.2	190	250	50/60	DC to 400	2000	1100

MTBF at 40°C, 230V, per Mil-HB-217F: 1,600,000 hours.

Insertion loss

Per CISPR 17; A = 50Ω/50Ω sym, B = 50Ω/50Ω asym, C = 0.1Ω/100Ω sym, D = 100Ω/0.1Ω sym

0.5 amp types

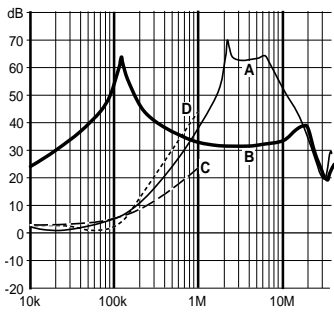

1 amp types

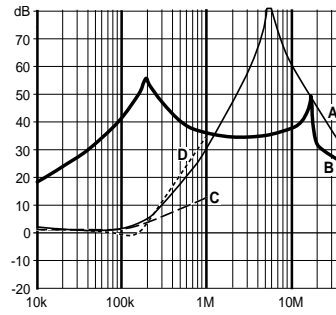

3 amp types

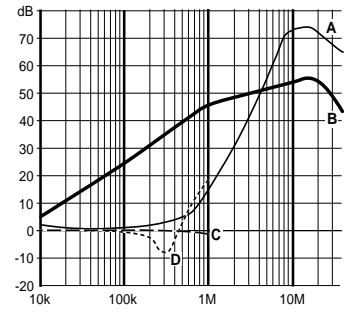

6 amp types

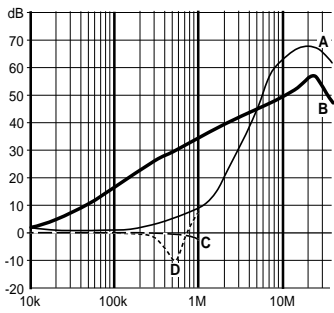

Electrical schematics

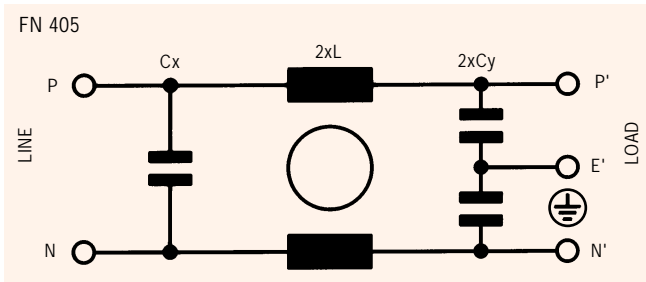

See tables for component values.

FN 406

Ultra-compact EMC filter

The FN 406 PCB-mounting EMC filter offers high performance in an exceptionally compact form, and is ideal for equipment applications where space is at a premium. With a footprint of just 15 x 45 mm, it greatly reduces the PCB area required compared with using discrete components, with a height profile which does not exceed the capacitors and transformers typically used in circuitry such as switched mode power supplies. Performance is also enhanced, thanks to an aluminium housing - providing excellent RF shielding to protect against coupling effects from nearby components.



See Mechanical Data (pages 54 and 60) for full details of housings and connections.

- 0.5-6A current ratings
- aluminium case
- very compact PCB-mounting design
- low profile

Filter selection table

Choose the family **FN xxx** with the required current rating and features, and add **/??** to determine input/output (line/load) connection style. Example: FN 406-6/02 is a 6A filter with pin connections.

Approvals



Family	Connections I	Current ratings		Inductance L mH	Housing	Weight g
		A at 40°C (25°)				
FN 406 -0.5/??	/02	0.5	(0.6)	24	A6	36
FN 406 -1 /??	/02	1	(1.2)	12	A6	36
FN 406 -3 /??	/02	3	(3.5)	2.5	A6	36
FN 406 -6 /??	/02	6	(6.9)	0.78	A6	36

Additional specifications

Filter type	Capacitance		Res. R MΩ	Maximum leakage µA/phase	Maximum operating voltage		Operating frequency Hz	Hipot test voltage	
	Cx nF	Cy nF			VAC	Hz		PN→E VAC	P→N VAC
Standard types	100	2.2	1	190	250	50/60	DC to 400	2000	1700
B types (medical)	100	-	1	2	250	50/60	DC to 400	2500	1700

MTBF at 40°C, 230V, per Mil-HB-217F: 1,900,000 hours.

Insertion loss

Per CISPR 17; A = 50Ω/50Ω sym, B = 50Ω/50Ω asym, C = 0.1Ω/100Ω sym, D = 100Ω/0.1Ω sym

0.5 amp types

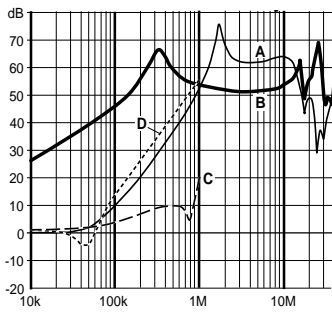

1 amp types

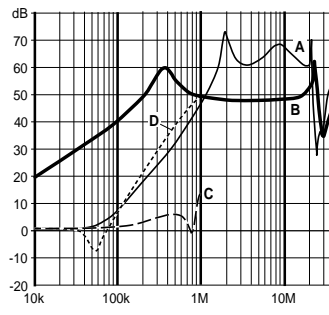

3 amp types

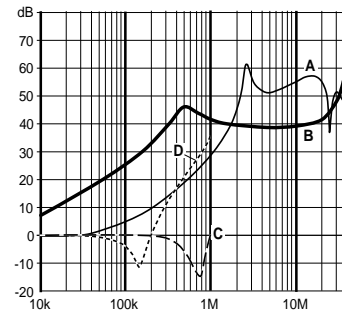

6 amp types

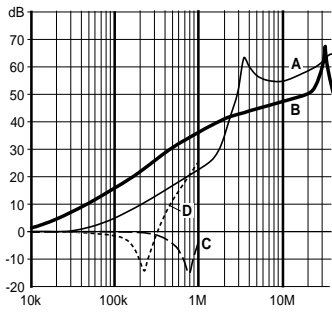

Electrical schematics

FN 406

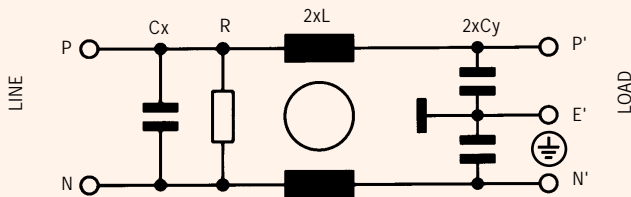

FN 406B

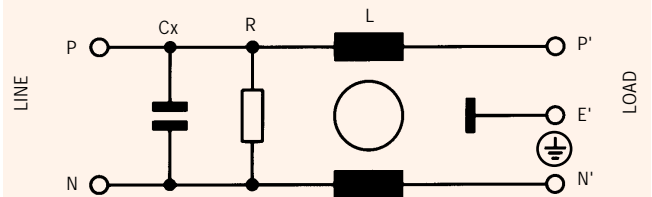

See tables for component values.

FN 410

Two-stage PCB filter

This filter, with its two-stage inductor design, offers high attenuation in a metal-cased PCB-mounting form.

- 0.5-6A current ratings
- high attenuation 2-stage design
- PCB-mounting



See Mechanical Data (pages 54 and 60) for full details of housings and connections.

Filter selection table

Choose the family **FN xxx** with the required current rating and features, and add *1??* to determine input/output (line/load) connection style. Example: FN 410-6/02 is a 6A filter with pin connections.

Approvals



Family	Connections 	Current ratings		Inductance L/L1 mH	Housing	Weight g
		A at 40°C (25°)				
FN 410 -0.5 1??	/02	0.5	(0.6)	24/24	E1	85
FN 410 -1 1??	/02	1	(1.2)	10/10	E1	85
FN 410 -3 1??	/02	3	(3.6)	2/2	E1	85
FN 410 -6 1??	/02	6	(6.9)	0.8/0.8	E1	85

Additional specifications

Filter type	Capacitance		Maximum leakage μA/phase	Maximum operating voltage		Operating frequency Hz	Hipot test voltage	
	Cx nF	Cy nF		VAC	Hz		PN→E VAC	P→N VDC
Standard types	33	2.2	190	250	50/60	DC to 400	2000	1700

MTBF at 40°C, 230V, per Mil-HB-217F: 675,000 hours.

Insertion loss

Per CISPR 17; A = 50Ω/50Ω sym, B = 50Ω/50Ω asym, C = 0.1Ω/100Ω sym, D = 100Ω/0.1Ω sym

0.5 amp types

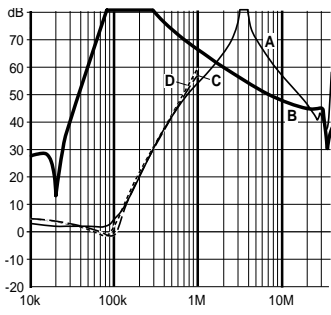

1 amp types

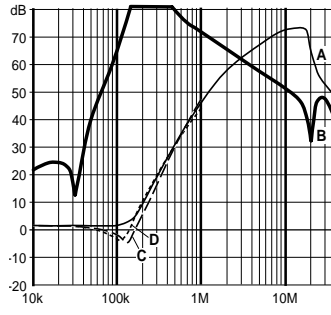

3 amp types

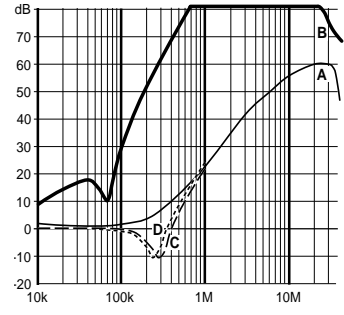

6 amp types

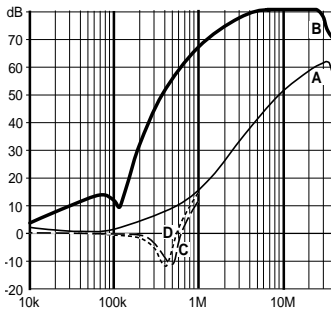

Electrical schematics

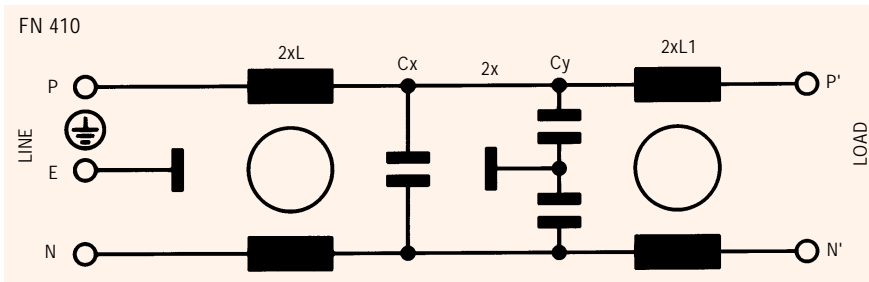

See tables for component values.

Versatile easy-mount filter

This low-cost filter is supplied in a flat case with rounded edges, making it easy to mount in almost any location - for great versatility and problem solving. Its medium-performance filter design is aimed at general-purpose applications.



See Mechanical Data (pages 54 and 60) for full details of housings and connections.

- 0.6-6.5A current ratings
- low profile case
- designed for easy-mounting

Filter selection table

Choose the family **FN xxx** with the required current rating and features, and add **/??** to determine input/output (line/load) connection style. Example: FN 422-4/13 is a 4A filter with mini fast-on connections.

Approvals



Family	Connections 	Current ratings		Inductance L mH
		A at 40°C (25°)		
FN 42? -0.6 /??	/13	0.6	(0.7)	22.5
FN 42? -1 /??	/13	1	(1.2)	13
FN 42? -2.5 /??	/13	2.5	(3)	3.4
FN 42? -4 /??	/13	4	(4.8)	2
FN 42? -6.5 /??	/13	6.5	(7.3)	0.75

Filter type	Capacitance		Res. R MΩ	Maximum leakage μA/phase	Maximum operating voltage		Operating frequency Hz	Hipot test voltage		Housing	Weight g
	Cx nF	Cy nF			VAC	Hz		PN→E VAC	P→N VDC		
FN 420 types	150	2.2	1	190	250	50/60	DC to 400	2000	1700	A7B	70
FN 421 types	100	2.2	-	190	250	50/60	DC to 400	2000	1700	A7A	60
FN 422 types	150	4.7	1	190	250	50/60	DC to 400	2000	1700	A7B	70

MTBF at 40°C, 230V, per Mil-HB-217F: 625,000 hours.

Electrical schematics

See tables for component values.

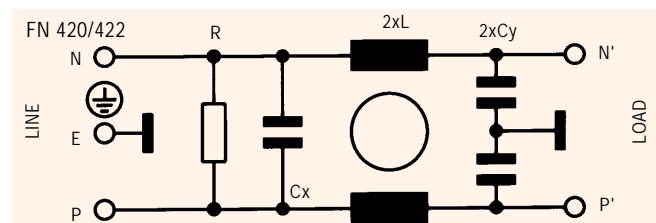
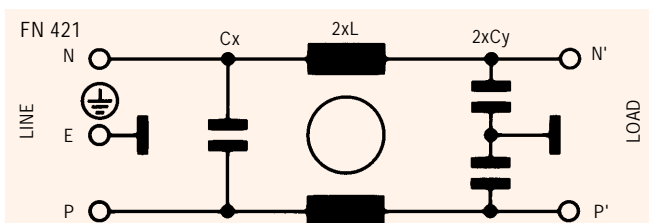

Insertion loss

Per CISPR 17;

- A = 50Ω/50Ω sym,
- B = 50Ω/50Ω asym,
- C = 0.1Ω/100Ω sym,
- D = 100Ω/0.1Ω sym

FN 420 0.6 amp types

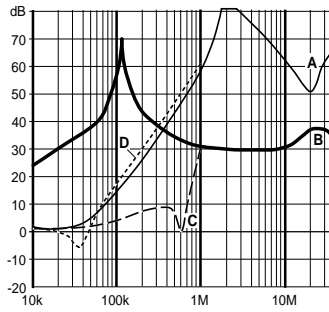

FN 420 1 amp types

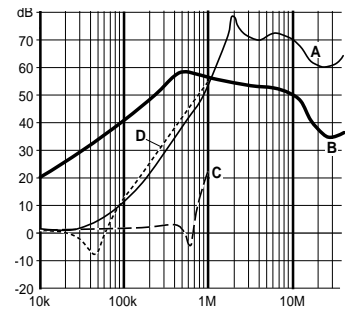

FN 420 2.5 amp types

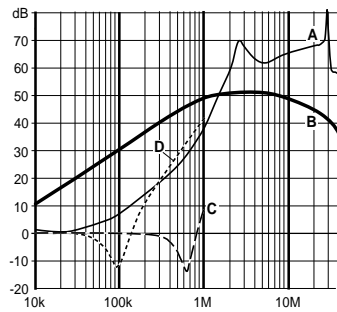

FN 420 4 amp types

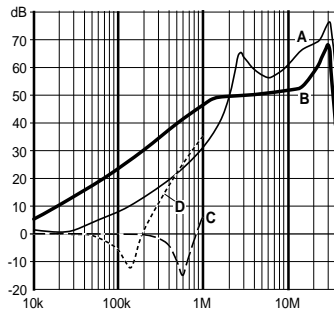

FN 420 6.5 amp types

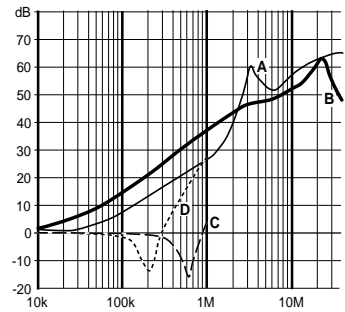

FN 421 1 amp types

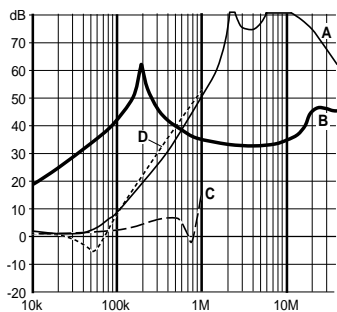

FN 421 2.5 amp types

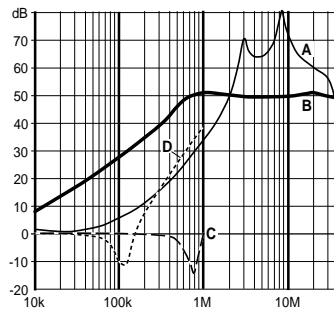

FN 421 4 amp types

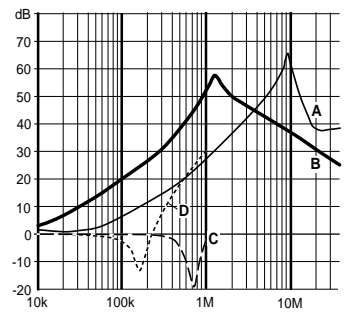

FN 421 6.5 amp types

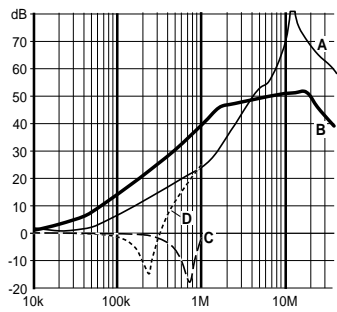

FN 422 0.6 amp types

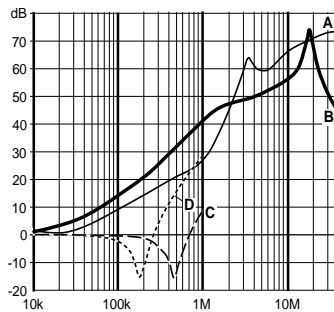

FN 422 1 amp types

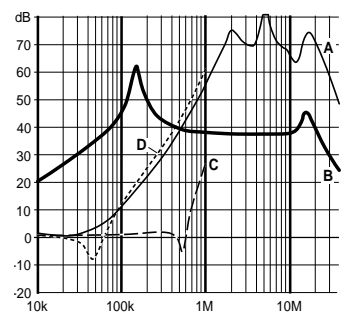

FN 422 2.5 amp types

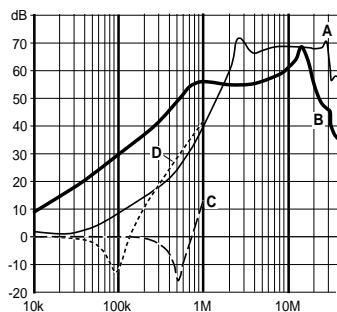

FN 422 4 amp types

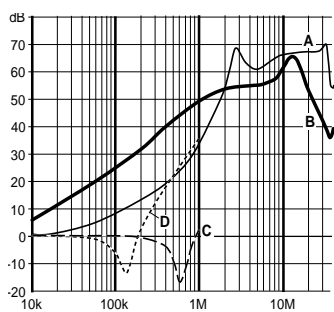

FN 422 6.5 amp types

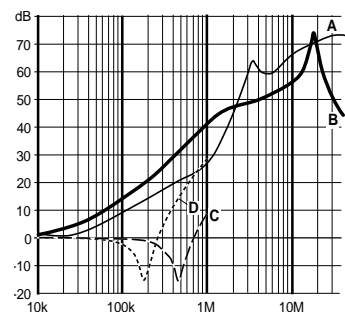

FN 610

General-purpose filter

This family is designed to provide an economic solution for many general-purpose filtering requirements. Available in over 19 versions, with current ratings from 1 to 30A and with a choice of four different styles of connections, application requirements are easily and economically matched.



See Mechanical Data (pages 57, 58 and 60) for full details of housings and connections.

- current ratings from 1 to 30A
- general-purpose filtering performance
- four choices of connector style
- optional medical version (B types)
- optional safety version (A types)

Filter selection table

Choose the family **FN xxx** with the required current rating and features, and add *???* to determine input/output (line/load) connection style. Example: FN 610-10/06 is a 10A filter with fast-on connections.

Approvals



(10A max. for Semko)

Family	Connections				Current ratings A at 40°C (25°)	Inductance L mH	Housing	Weight g	
								<i>???</i>	<i>/07</i>
FN 610 -1 <i>???</i>	-	/06	/07	-	1 (1.15)	3	F1	55	65
FN 610 -3 <i>???</i>	-	/06	/07	-	3 (3.4)	2	F1	60	70
FN 610 -6 <i>???</i>	-	/06	/07	-	6 (6.9)	0.75	F1	60	70
FN 610 -10 <i>???</i>	-	/06	/07	-	10 (11.5)	0.45	F2	85	95
FN 610 -20 <i>???</i>	-	/06	-	-	20 (23)	0.48	J1	220	-
FN 610 -30 <i>???</i>	/03	-	-	/10	30 (34)	0.61	L1	630	-

Additional specifications

Filter type	Capacitance		Res. R MΩ	Maximum leakage μA/phase	Maximum operating voltage		Operating frequency Hz	Hipot test voltage	
	Cx nF	Cy nF			VAC	Hz		PN→E VAC	P→N VAC
Standard types	33	2.2	-	190	250	50/60	DC to 400	2000	1700
A types (safety)	33	0.47	1	40	250	50/60	DC to 400	2500	1700
B types (medical)	33	-	1	2	250	50/60	DC to 400	2500	1700

MTBF at 40°C, 230V, per Mil-HB-217F: 1,200,000 hours.

Insertion loss

Per CISPR 17; A = 50Ω/50Ω sym, B = 50Ω/50Ω asym, C = 0.1Ω/100Ω sym, D = 100Ω/0.1Ω sym

1 amp types

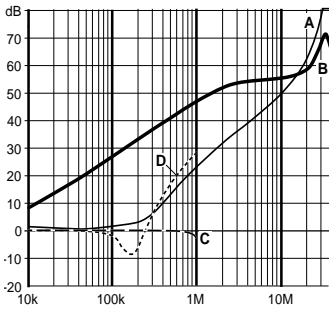

3 amp types

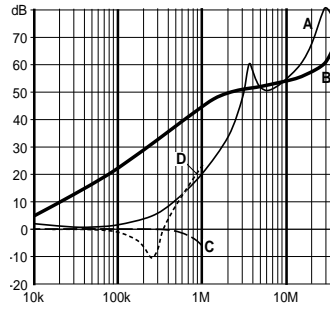

6 amp types

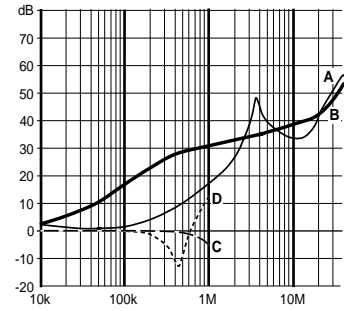

10 amp types

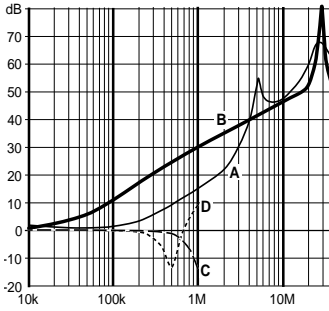

20 amp types

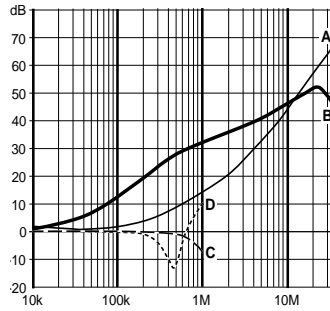

30 amp types

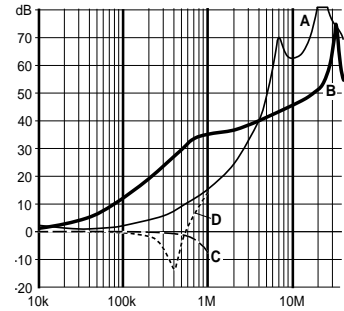

1 amp (A types)

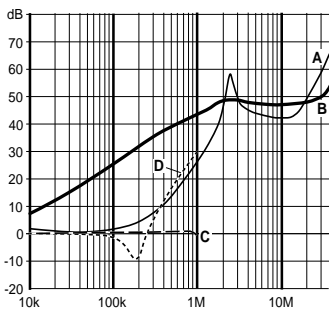

3 amp (A types)

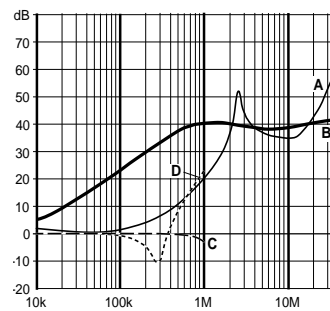

6 amp (A types)

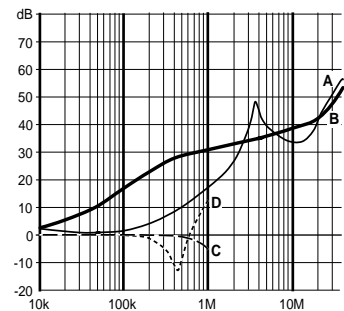

Electrical schematics

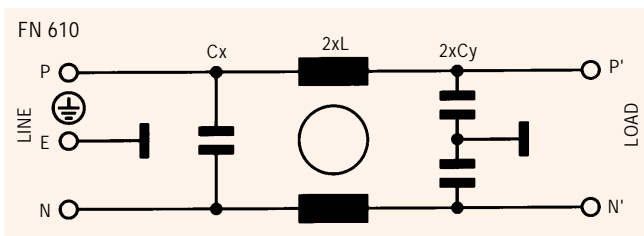

10 amp (A types)

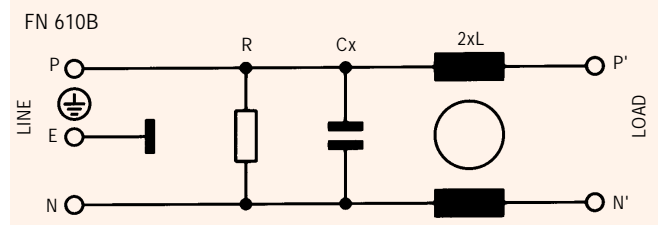
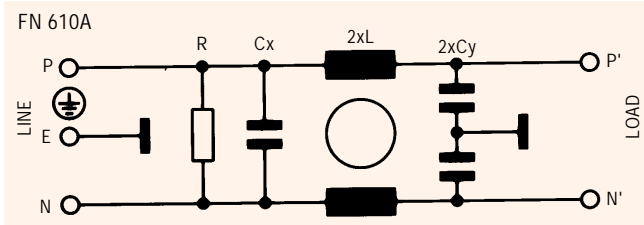
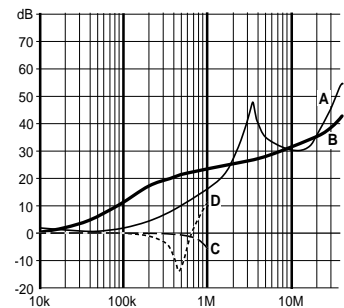

See tables for component values.

FN 612

General-purpose filter

Like the FN 610, but with additional capacitance for improved differential mode performance, this family is designed to provide an economic solution for many general-purpose filtering requirements. Available in numerous versions, with current ratings from 1 to 30A and with a choice of four different styles of connection, application requirements are easily and economically matched.



See Mechanical Data (pages 57, 58 and 60) for full details of housings and connections.

- current ratings from 1 to 30A
- good differential mode attenuation
- four choices of connector
- optional medical versions (B type)

Filter selection table

Choose the family **FN xxx** with the required current rating and features, and add *???* to determine input/output (line/load) connection style. Example: FN 612-1/06 is a 1A filter with fast-on connections.

Approvals



Family	Connections				Current ratings A at 40°C (25°)	Inductance L mH	Housing	Weight g			
								/03	/06	/07	/10
FN 612 -1 <i>???</i>	-	/06	/07	-	1 (1.15)	3	H1	-	80	90	-
FN 612 -3 <i>???</i>	-	/06	/07	-	3 (3.4)	2	H2	-	115	125	-
FN 612 -6 <i>???</i>	-	/06	/07	-	6 (6.9)	0.75	H2	-	115	125	-
FN 612 -10 <i>???</i>	-	/06	/07	-	10 (11.5)	0.45	H2	-	115	125	-
FN 612 -20 <i>???</i>	/03	/06	-	/10	20 (23)	0.48	H2	290	260	-	290
FN 612 -30 <i>???</i>	/03	-	-	/10	30 (34)	0.61	L1	630	-	-	630

Additional specifications

Filter type	Capacitance		Res. R MΩ	Maximum leakage μA/phase	Maximum operating voltage		Operating frequency Hz	Hipot test voltage	
	Cx nF	Cy nF			VAC	Hz		PN→E VAC	P→N VDC
Standard types	100	2.2	1	190	250	50/60	DC to 400	2000	1700
B types (medical)	100	-	1	2	250	50/60	DC to 400	2500	1700

MTBF at 40°C, 230V, per Mil-HB-217F: 800,000 hours.

Insertion loss

Per CISPR 17; A = $50\Omega/50\Omega$ sym, B = $50\Omega/50\Omega$ asym, C = $0.1\Omega/100\Omega$ sym, D = $100\Omega/0.1\Omega$ sym

1 amp types

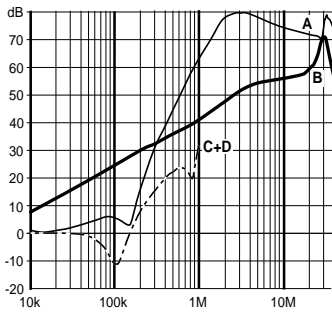

3 amp types

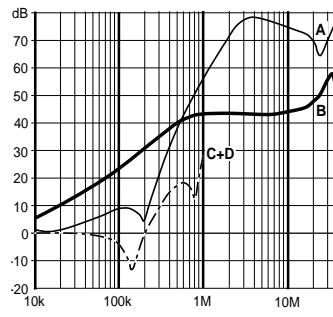

6 amp types

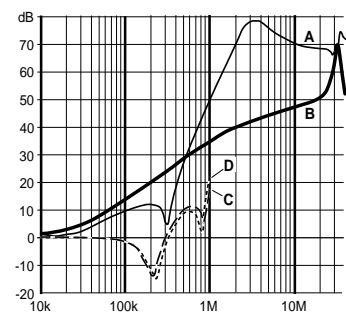

10 amp types

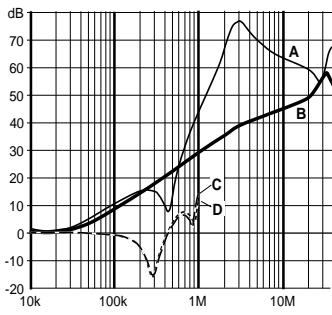

20 amp types

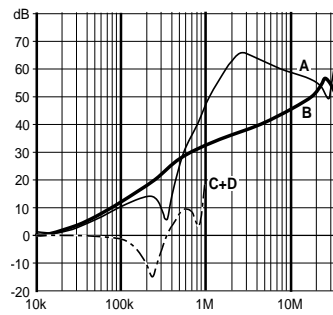

30 amp types

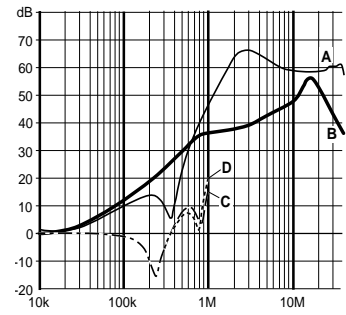

Electrical schematics

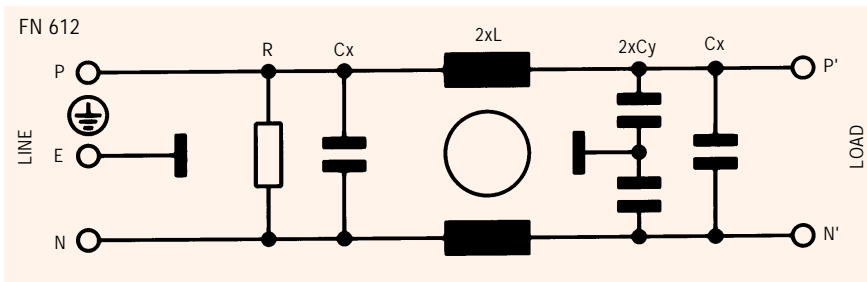

See tables for component values.

Two-stage general-purpose filter

Like the FN 612, but with an additional inductance stage for higher common mode attenuation, this family is designed to provide an economic solution for many general-purpose filtering requirements. Available in 14 versions, with current ratings from 1 to 20A and with a choice of four different styles of connection, application requirements are easily and economically matched.



See Mechanical Data (pages 57, 58 and 60) for full details of housings and connections.

- current ratings from 1 to 20A
- high differential and common mode attenuation
- four choices of output connector
- optional medical versions (B type)

Filter selection table

Choose the family **FN xxx** with the required current rating and features, and add *???* to determine input/output (line/load) connection style. Example: FN 660-3/07 is a 3A filter with wire connections.

Approvals



Family	Connections				Current ratings A at 40°C (25°)	Inductance L/L ₁ mH	Housing	Weight g			
								/03	/06	/07	/10
FN 660 -1 <i>???</i>	-	/06	/07	-	1 (1.15)	3/3	H21	-	115	125	-
FN 660 -3 <i>???</i>	-	/06	/07	-	3 (3.4)	2/2	K1	-	170	180	-
FN 660 -6 <i>???</i>	-	/06	/07	-	6 (6.9)	0.75/0.75	K1	-	170	180	-
FN 660 -10 <i>???</i>	-	/06	/07	-	10 (11.5)	0.45/0.45	K21	-	230	240	-
FN 660 -16 <i>???</i>	/03	/06	-	/10	16 (18.4)	0.44/0.44	K2	290	260	-	290
FN 660 -20 <i>???</i>	/03	/06	-	/10	20 (23)	0.48/0.48	L1	600	590	-	640

Additional specifications

Filter type	Capacitance		Res. R MΩ	Maximum leakage μA/phase	Maximum operating voltage		Operating frequency Hz	Hipot test voltage	
	C _x nF	C _y nF			VAC	Hz		PN→E VAC	P→N VAC
Standard types	150	2.2	1	190	250	50/60	DC to 400	2000	1700
B types (medical)	150	-	1	2	250	50/60	DC to 400	2500	1700

MTBF at 40°C, 230V, per Mil-HB-217F: 350,000 hours (for VDE-approved current ratings).

Insertion loss

Per CISPR 17; A = $50\Omega/50\Omega$ sym, B = $50\Omega/50\Omega$ asym, C = $0.1\Omega/100\Omega$ sym, D = $100\Omega/0.1\Omega$ sym

1 amp types

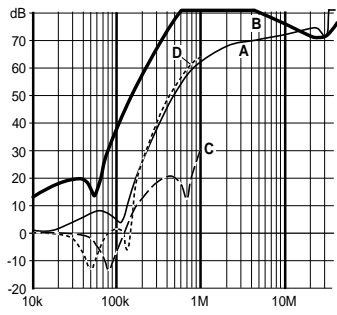

3 amp types

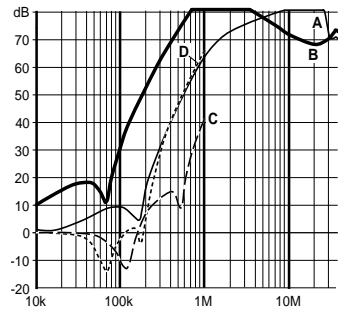

6 amp types

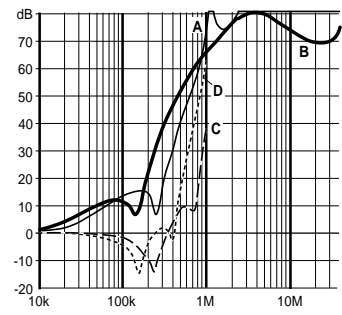

10 amp types

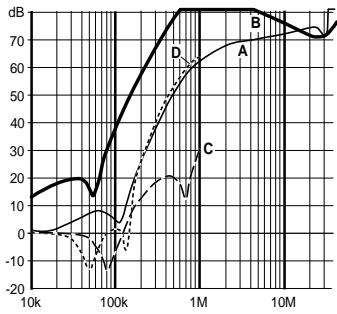

16 amp types

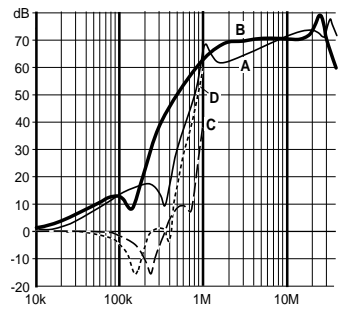

20 amp types

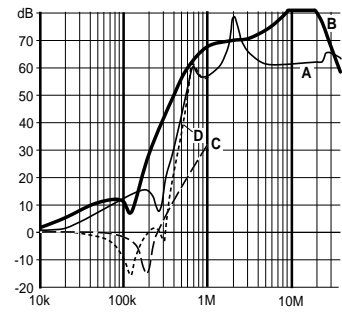

Electrical schematics

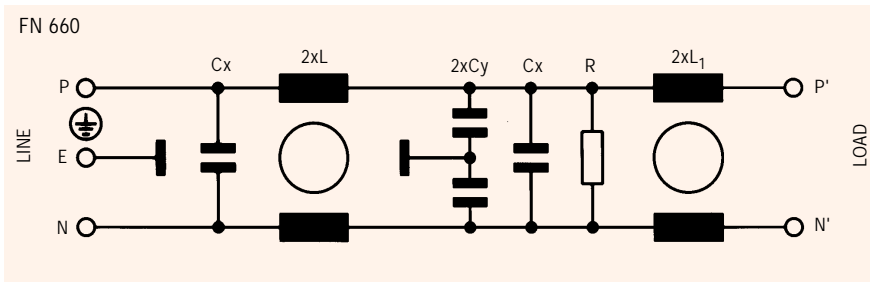

See tables for component values.

FN 670

Two-stage performance filter

Like the FN 660, but with even higher component values for excellent common- and differential- mode attenuation especially at high frequencies, this family is designed to provide an economic solution for broadband filtering requirements. Available in 12 versions, with current ratings to 10A, the filters are ideal for use with precision instrumentation, switched-mode power supplies and motor drives.



See Mechanical Data (pages 58 and 60) for full details of housings and connections.



- current ratings from 1.8 to 10A
- very high differential and common mode attenuation
- good high frequency attenuation

Filter selection table

Choose the family **FN xxx** with the required current rating and features, and add */??* to determine input/output (line/load) connection style. Example: FN 670-3/06 is a 3A filter with fast-on connections.

Approvals



Family	Connections		Current ratings A at 40°C (25°)	Inductance L/L ₁ mH	Housing	Weight g	
						/06	/07
FN 670 -1.8 <i>/??</i>	/06	/07	1.6 (1.8)	7.2/7.2	K2	225	240
FN 670 -3 <i>/??</i>	/06	/07	2.5 (3)	12.2/1.8	K2	240	245
FN 670 -6 <i>/??</i>	/06	/07	5 (6)	7/7	K2	245	260
FN 670 -10 <i>/??</i>	/06	/07	8.0 (10)	10.4/2.7	L1	570	620

Additional specifications

Filter type	Capacitance		Res. R MΩ	Maximum leakage μA/phase	Maximum operating voltage		Operating frequency Hz	Hipot test voltage	
	C _x /C _{x1} nF	C _y nF			VAC	Hz		PN→E VAC	P→N VAC
Standard types	470/150	2.2	0.47	190	250	50/60	DC to 400	2000	1700

MTBF at 40°C, 230V, per Mil-HB-217F: 300,000 hours (for VDE-approved current ratings).

Insertion loss

Per CISPR 17; A = 50Ω/50Ω sym, B = 50Ω/50Ω asym, C = 0.1Ω/100Ω sym, D = 100Ω/0.1Ω sym

1.8 amp types

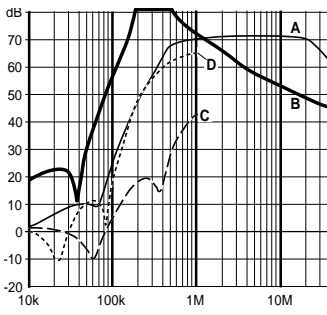

3 amp types

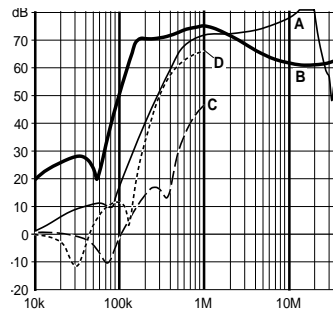

6 amp types

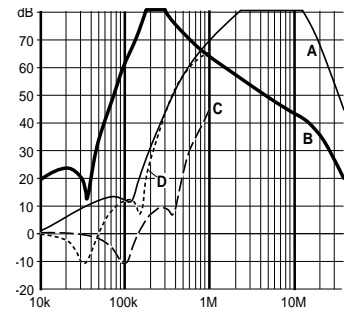

10 amp types

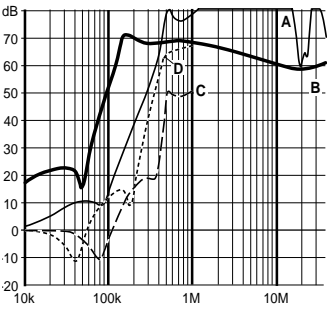

Electrical schematics

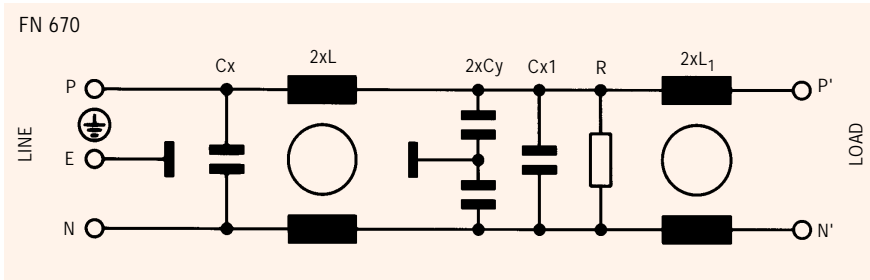

See tables for component values.

Two-stage performance filter

Like the FN 670, but with improved component values and a rod core for excellent attenuation at all frequencies including low ranges, this general-purpose filter is an excellent choice for protecting against very high levels of interference, such as noisy power supplies. Available in 10 versions, with current ratings from 1 to 10A, application requirements are easily and economically matched.



- current ratings from 1 to 10A
- very high differential and common mode attenuation
- good low frequency attenuation



See Mechanical Data (pages 57, 58 and 60) for full details of housings and connections.

Filter selection table

Choose the family **FN xxx** with the required current rating and features, and add */??* to determine input/output (line/load) connection style. Example: FN 682-4/07 is a 4A filter with wire connections.

Approvals



Family	Connections		Current ratings		Inductance L/L1 mH	Housing	Weight g	
			A at 40°C (25°)				/06	/07
FN 680 -1 <i>/??</i>	/06	/07	1	(1.2)	22.5/1.2	J11	120	130
FN 680 -2.5 <i>/??</i>	/06	/07	2.5	(3)	16/0.27	K2	230	245
FN 682 -4 <i>/??</i>	/06	/07	4	(4.8)	8/0.08	K2	250	255
FN 682 -6.5 <i>/??</i>	/06	/07	6.5	(7.8)	4.1/0.055	L1	590	600
FN 682 -10 <i>/??</i>	/06	/07	10	(12)	4/0.04	L2	950	970

Additional specifications

Filter type	Capacitance		Res. R MΩ	Maximum leakage μA/phase	Maximum operating voltage		Operating frequency Hz	Hipot test voltage	
	Cx nF	Cy nF			VAC	Hz		PN→E VAC	P→N VDC
FN 680 types	220	4.7	1	410	250	50/60	DC to 400	2000	1700
FN 682 types (4A)	1000	22	0.33	1900	250	50/60	DC to 400	2000	1700
FN 682 types (6.5-10A)	470	22	0.47	1900	250	50/60	DC to 400	2000	1700

MTBF at 40°C, 230V, per Mil-HB-217F: 1,400,000 hours.

Insertion loss

Per CISPR 17; A = 50Ω/50Ω sym, B = 50Ω/50Ω asym, C = 0.1Ω/100Ω sym, D = 100Ω/0.1Ω sym

1 amp types

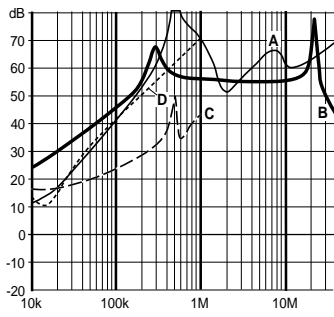

2.5 amp types

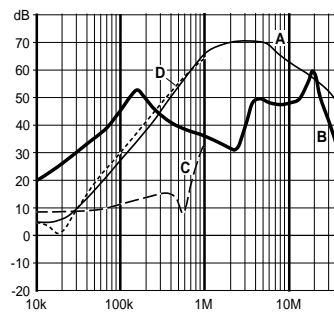

4 amp types

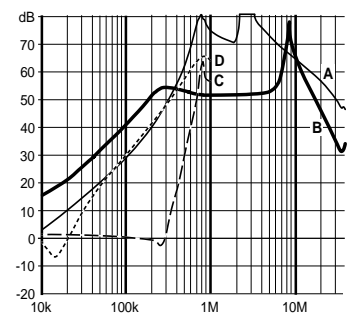

6.5 amp types

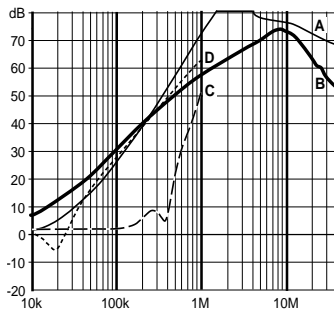

10 amp types

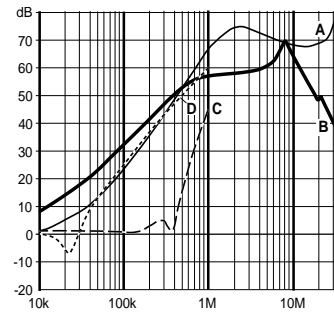

Electrical schematics

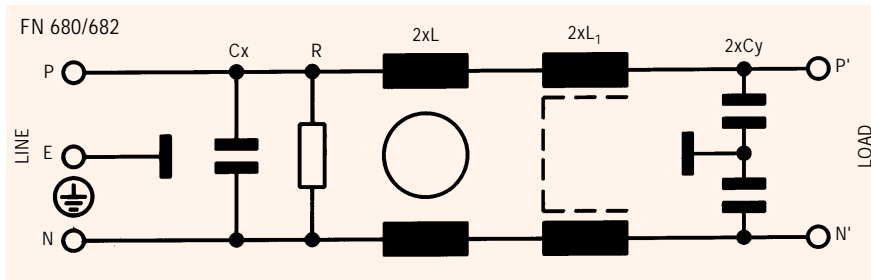

See tables for component values.

FN 685

High-power performance filter

Like the FN 680, but with even higher inductance values for excellent common- and differential- mode attenuation especially at high frequencies, this family is designed to provide a solution for broadband filtering requirements. Available in 12 versions, with current ratings to 36A, the filters are ideal for use with switched-mode power supplies, computers and other digital systems.



See Mechanical Data (pages 55 and 60) for full details of housings and connections.

- current ratings from 10 to 36A
- excellent attenuation characteristics

Filter selection table

Choose the family **FN xxx** with the required current rating and features, and add *??* to determine input/output (line/load) connection style. Example: FN 685-10/06 is a 10A filter with fast-on connections.

Approvals



Family	Connections			Current ratings A at 40°C (25°)	Inductance L/L1 mH	Housing	Weight g
FN 685 -10 <i>??</i>	/03	/06	-	10 (12)	4.2/40	B7A	1200
FN 685 -16 <i>??</i>	/03	/06	-	16 (19.2)	2.3/0.04	B7A	1350
FN 686 -25 <i>??</i>	-	-	/23	25 (30)	1.35/0.04	B23	2350
FN 686 -36 <i>??</i>	-	-	/23	36 (43.2)	0.8/0.03	B23	2850

Additional specifications

Filter type	Capacitance		Res. R MΩ	Maximum leakage μA/phase	Maximum operating voltage		Operating frequency Hz	Hipot test voltage	
	Cx/Cx1 nF	Cy nF			VAC	Hz		PN→E VAC	P→N VDC
FN 685 types	470/220	4.7	0.33	410	250	50/60	DC to 400	2000	1700
FN 686 types	470/220	22	0.33	1900	250	50/60	DC to 400	2000	1700

MTBF at 40°C, 230V, per Mil-HB-217F: 400,000 hours.

Insertion loss

Per CISPR 17; A = 50Ω/50Ω sym, B = 50Ω/50Ω asym, C = 0.1Ω/100Ω sym, D = 100Ω/0.1Ω sym

10 amp types

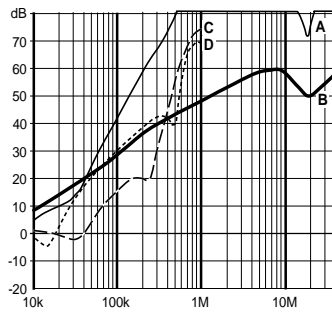

16 amp types

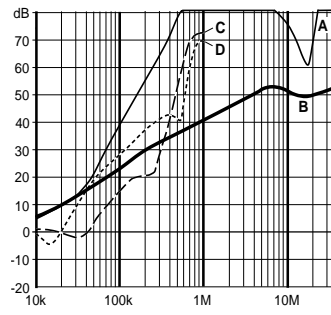

25 amp types

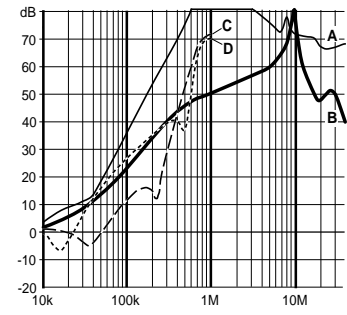

36 amp types

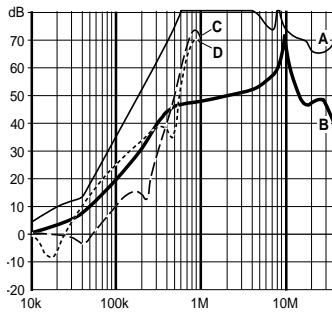

Electrical schematics

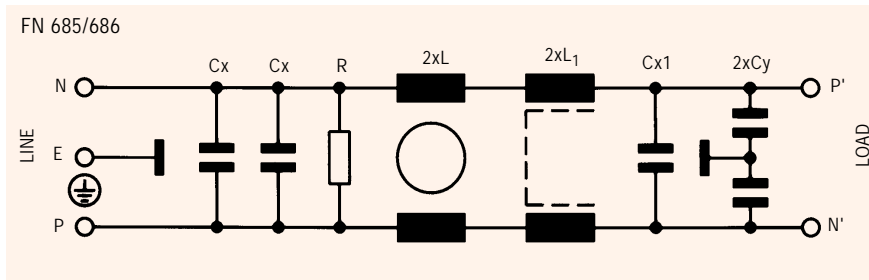

See tables for component values.

Three-stage filter

Offering outstanding noise suppression at frequencies up to 3GHz, together with protection against nuclear electromagnetic pulses and very high surge voltages, this filter provides a ready-to-use option for high-integrity equipment designs. Applications include systems requiring TEMPEST and NEMP protection, and overcoming sensitive interference problems with commercial equipment.



See Mechanical Data (pages 56 and 60) for full details of housings and connections.

- current ratings from 6 to 20A (6 and 10A options with IEC inlets)
- TEMPEST
- NEMP
- attenuation to 3GHz
- protection against high surge voltages

Filter selection table

Choose the family **FN xxx** with the required current rating and features, and add **/??** to determine input/output (line/load) connection style. Example: FN 700Z-20/03 is a 20A filter with M4 screw clamp connections.

Approvals

Family	Connections		Current ratings		Res R MΩ	Inductance		Housing	Weight g
			A at 40°C (25°)			L μH	L ₁ mH		
FN 700Z -6 /??	-	/06	6	(6.9)	0.33	50	17.1	B24	2000
FN 700Z -10 /??	-	/06	10	(11.6)	0.33	50	9.4	B25	2300
FN 700Z -20 /??	/03	-	20	(23)	0.33	60	5.5	B26	3500

Additional specifications

Filter type	Capacitance		Maximum leakage μA/phase	Maximum operating voltage		Operating frequency Hz	Hipot test voltage	
	C _x /C _{x1} μF	C _y /C _{y1} nF		VAC	Hz		PN→E VAC	P→N VAC
6A/10A types	1/-	2.5/-	440	250	50/60	DC to 400	590	590
20A types	1/2.2	5/10	2600	250	50/60	DC to 60	590	590

MTBF at 40°C, 230V, per Mil-HB-217F: 450,000 hours.

Insertion loss

Per CISPR 17; A = 50Ω/50Ω sym, B = 50Ω/50Ω asym, C = 0.1Ω/100Ω sym, D = 100Ω/0.1Ω sym

6 amp types

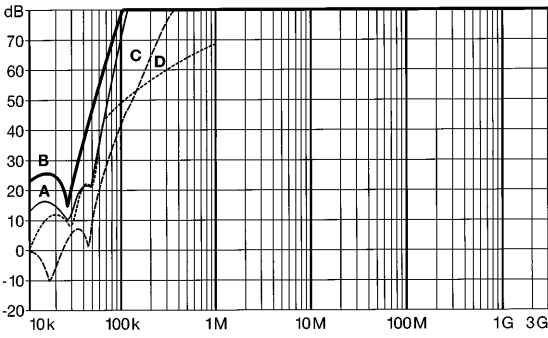

10 amp types

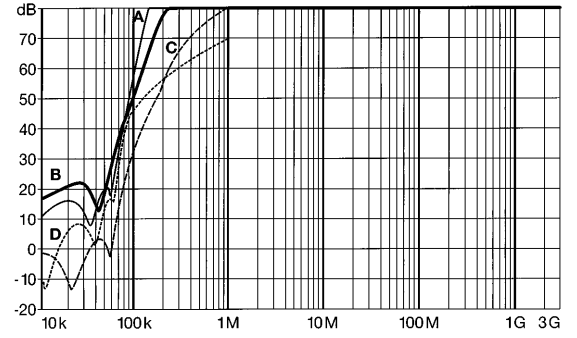

20 amp types

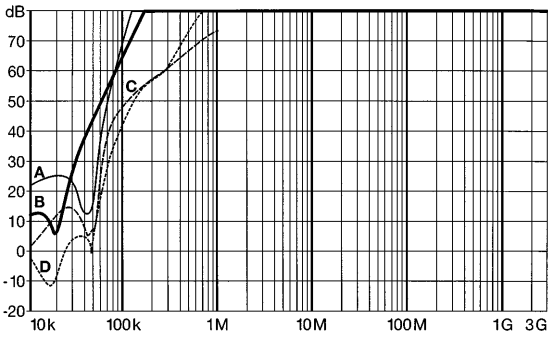

Electrical schematics

FN 700Z-6, FN 700Z-10

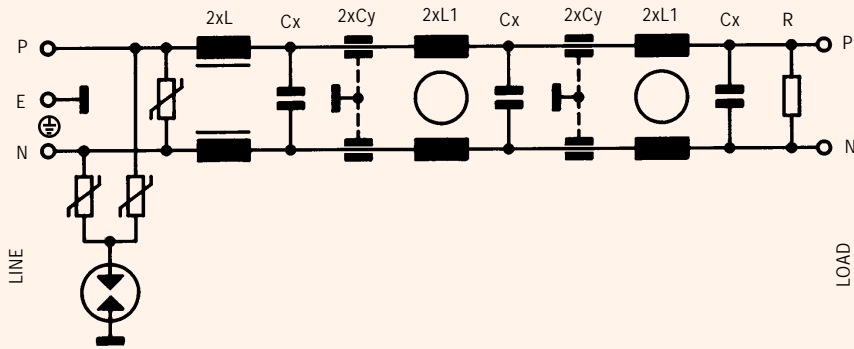

FN 700Z - 20

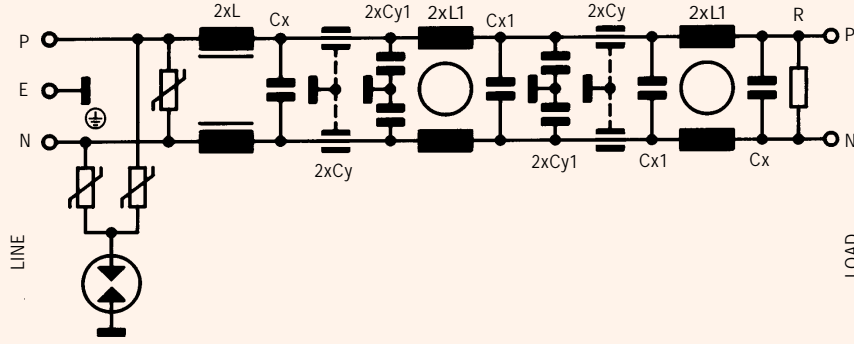

See tables for component values.

Compact performance filter

This one-stage filter is constructed using a novel winding technique, to provide the kind of performance usually found only in more expensive two-stage designs. Consequently, it is an excellent choice for solving more difficult interference problems, where equipment space is at a premium, such as in high-density switched-mode power supplies.

- current ratings from 3 to 16A
- economic high-performance filter
- screw or fast-on connections





See Mechanical Data (pages 58 and 60) for full details of housings and connections.

Filter selection table

Choose the family **FN xxx** with the required current rating and features, and add *???* to determine input/output (line/load) connection style. Example: FN 9675-3/06 is a 3A filter with fast-on connections.

Approvals



Family	Connections		Current ratings A at 40°C (25°)	Inductance L mH	Capacitance Cx/Cx ₁ nF	Housing	Weight g
							
FN 9675 -3 /??	-	/06	3 (3.5)	18	680/680	K21	270
FN 9675 -6 /??	-	/06	6 (6.9)	3	680/680	K21	270
FN 9675 -16 /??	/03	-	16 (18.4)	10.2	1000/1000	L2	850
FN 9676 -16 /??	/03	-	16 (18.4)	10.2	1000/1000	L2	1050

Additional specifications

Filter type	Capacitance Cy/Cy ₁ nF	Res. R MΩ	Maximum leakage μA/phase	Maximum operating voltage		Operating frequency Hz	Hipot test voltage	
				VAC	Hz		PN→E VAC	P→N VDC
FN 9675 types	4.7/-	0.47	410	250	50/60	DC to 400	2000	1700
FN 9676 types	6.8/15	0.47	1900	250	50/60	DC to 400	2000	1700

MTBF at 40°C, 230V, per Mil-HB-217F: 280,000 hours (FN 9675); 400,000 hours (FN 9676).

Insertion loss

Per CISPR 17; A = 50Ω/50Ω sym, B = 50Ω/50Ω asym, C = 0.1Ω/100Ω sym, D = 100Ω/0.1Ω sym

3 amp types

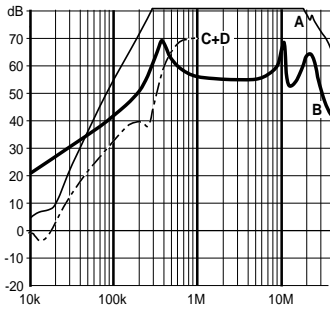

6 amp types

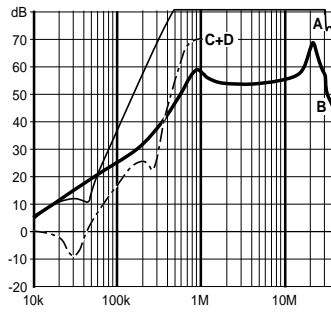

16 amp FN 9675

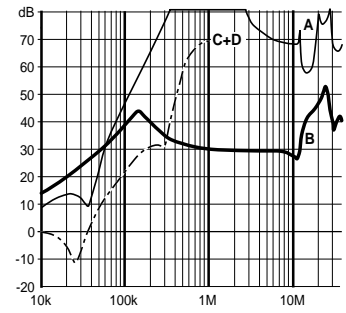

16 amp FN 9676

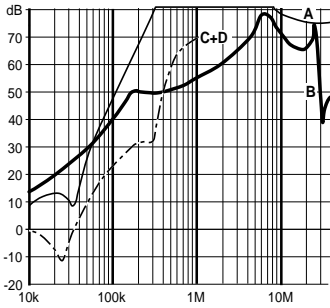

Electrical schematics

FN 9675 (3 and 6A)

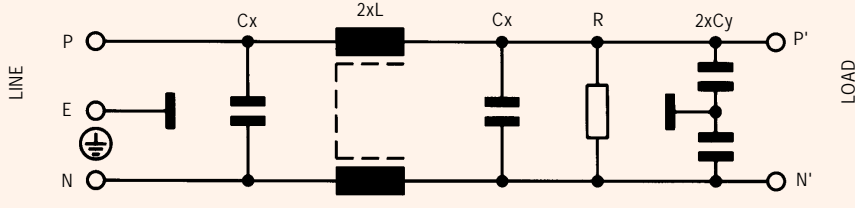

FN 9675 (16A)

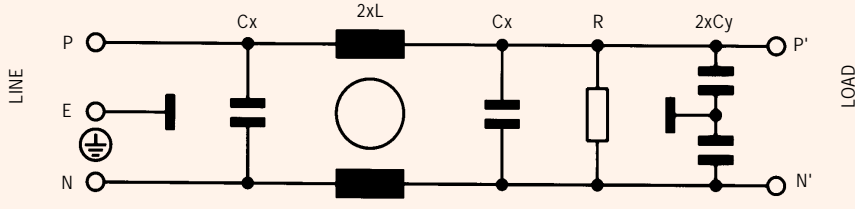

FN 9676 (16A)

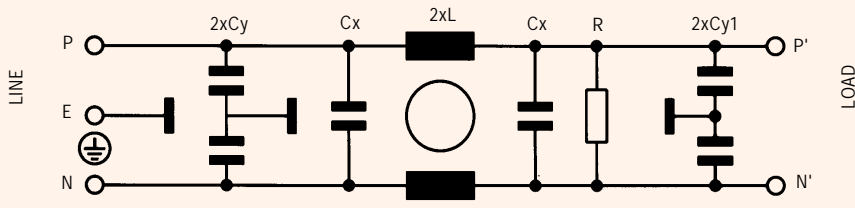

See tables for component values.

	FN 406 Housing A6	FN 410 E1	FN 421 A7A	FN 420, FN 422 A7B	Tol.* mm
A	45 ± 0.2	72 ± 0.8	70	83	± 0.5
B	15	33 ± 1	31	41 ± 0.3	± 0.5
C	28	19 ± 0.5		17	± 0.3
D	1.5 ± 0.3		54	65.8	± 0.2
E				31	± 0.5
F	10.16 ± 0.1	60		40	± 0.2
G	7.62	15 ± 0.2		5.5 ± 0.3	± 0.1
H	7.62				± 0.1
J	7.62			15.2 ± 0.3	± 0.1
K				1	± 0.1
L	1.27				-
M				∅5	± 0.1

* Measurements share this common tolerance unless otherwise stated.

BOTTOM VIEW

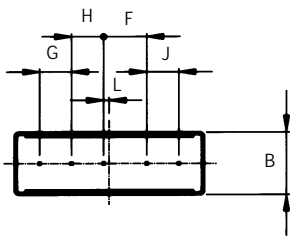

Housing A6

BOTTOM VIEW

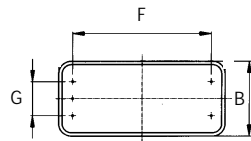

Housing E1

SIDE VIEW

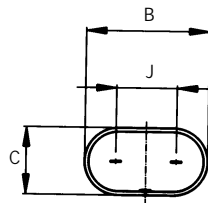

Housing A7A

SIDE VIEW

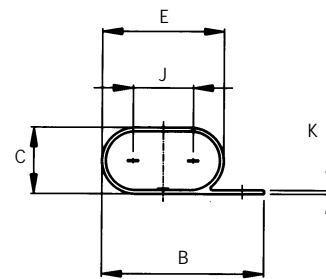

Housing A7B

SIDE VIEW

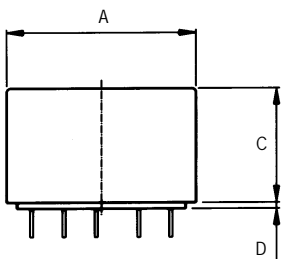

Housing A6

SIDE VIEW

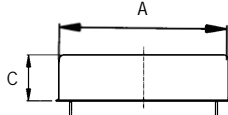

Housing E1

TOP VIEW

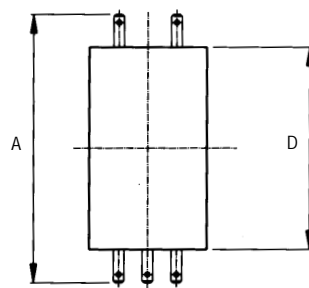

Housing A7A

TOP VIEW

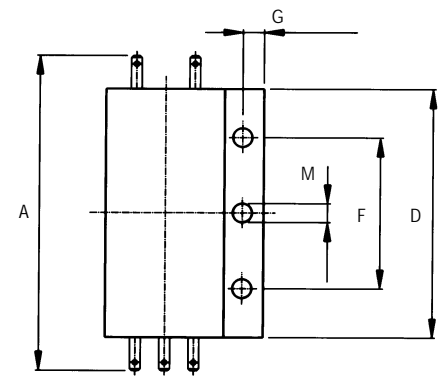

Housing A7B

Mechanical Data



	FN 357-6, -10 FN 685 Housing B7, B7A	FN 352Z-10 B8	FN 357-16 B11	FN 352Z-20 FN 353Z-30 B13	FN 350-55 B21	FN 352Z-6 B22	FN 686 B23	Tol.* mm
A	150	150.5	175	200	180	152	170	± 0.5
B	105	126 ⁺⁰ ₋₁	130	150	115	51	129 ± 1	± 0.5
C	50	55.25	65		60	45	60	± 0.5
D	75	100.5	100	119.5	85	133	100	± 0.5
E	85	85	90	115	115 ± 0.3	143 ± 0.3	115 ± 0.2	± 0.1
F	90	112 ⁺⁰ _{-0.4}	115	135 - 0.6	100		113 ± 0.2	± 0.5
J					17	27		± 0.5
K	11					27	15	± 0.5
L	20					9.5	24	± 0.5
M	6.5		6.5	6.4	6.4	7	6.5	± 0.1
N						5.3		± 0.1

* Measurements share this common tolerance unless otherwise stated.

SIDE VIEW

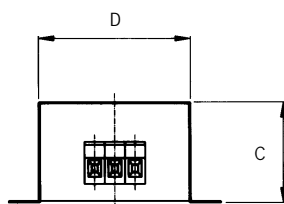

Housing B7, B8, B11
(Connection /29)

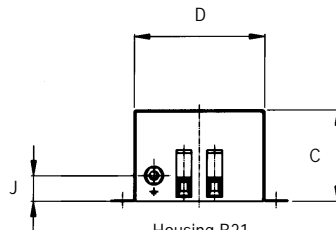

Housing B21
(Connection /33)

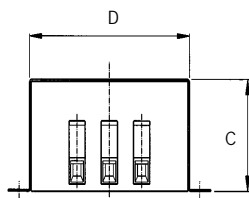

Housing B13
(Connection /33)

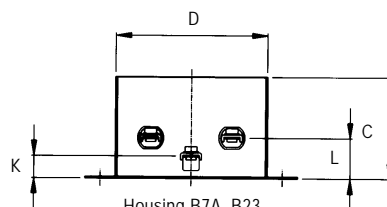

Housing B7A, B23
(Connection /03)

FRONT VIEW

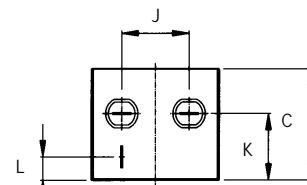

Housing B22

TOP VIEW

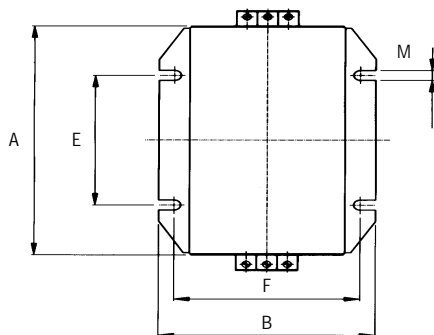

Housing B7, B7A, B8, B11,
B13, B21, B23

TOP VIEW

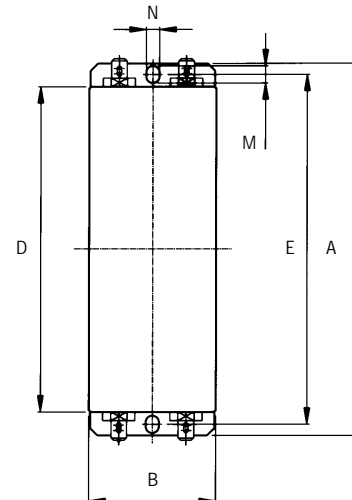

Housing B22

	FN 700Z-6 Housing B24	FN 700Z-10 B25	FN 700Z-20 B26	FN 346 B27	Tol.* mm
A	200	250	275	75.9 ⁺⁰ _{-0.3}	± 0.3
B	80		110	55.6 ± 0.5	± 0.3
C		50		42 ± 0.5	± 0.2
D	30		34 ± 0.2		± 0.3
E	40		94 ± 0.2	40	± 0.1
F	85	100	112.5		± 0.2
G	85	100	112.5		± 0.2
H	15	25	25		± 0.3
J	40		60 ± 0.5	27 ± 0.2	± 0.3
K	30		25 ± 0.3	12	± 0.5
L	20		35 ± 0.5		± 0.3
M	50		94 ± 0.1		± 0.2
R	M4			M3	-
Y				AWG 18	-
Z				140	± 5

* Measurements share this common tolerance unless otherwise stated.

FRONT VIEW

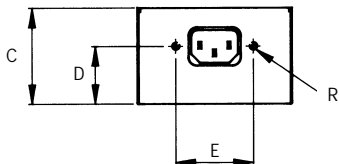

Housing B24, B25

BACK VIEW

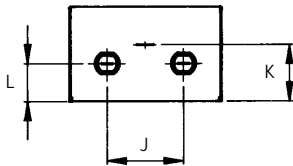

Housing B24, B25

BOTTOM VIEW

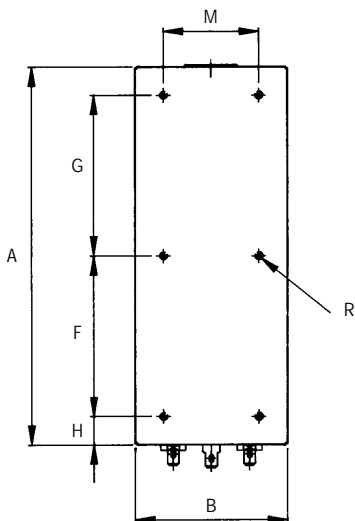

Housing B24, B25

FRONT VIEW

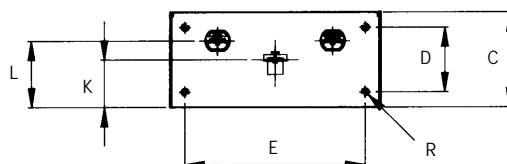

Housing B26

BOTTOM VIEW

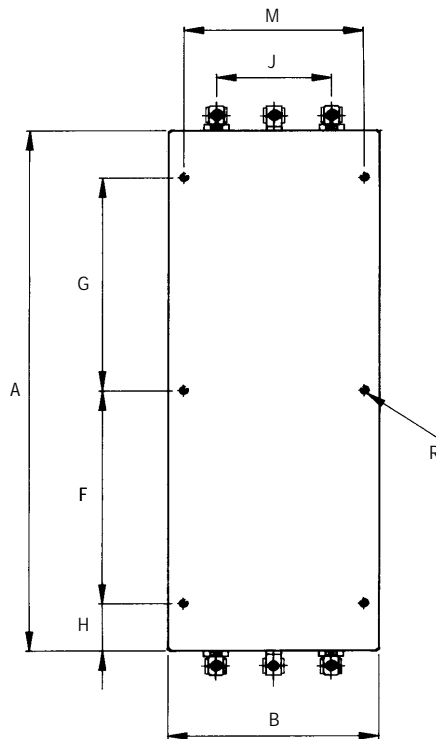

Housing B26

FRONT VIEW

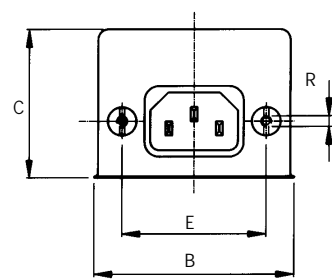

Housing B27

SIDE VIEW

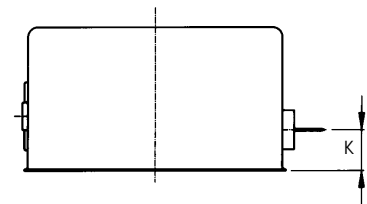

TOP VIEW

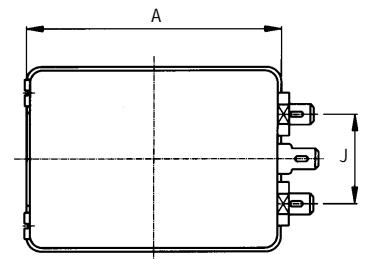

Housing B27

	FN 610 -1-3-6	FN 610-10	FN 332	FN 612-1	FN 612 -3-6-10	FN 612 -20	FN 660-1	FN 610 -20	FN 680-1	FN 343	Tol.* mm
	Housing F1	F2	G1	H1	H2	H2	H21	J1	J11	J2	
A	64		45	71		85	71			70	± 0.5
B	33		41	46.6 ± 1		54 ± 1	46.6 ± 1	52.6		69	± 0.5
C	19	29	24.8	22 ± 1	29 ± 1	40 ± 1	29 ± 1	29		30 ± 1	± 0.5
D	44		29 ± 0.5	50.5 ± 1		65 ± 1	50.5 ± 1	50.5 ± 1		49.8 ± 1	± 0.3
F	54		37 ± 0.4	61		75	61			60 ± 0.2	± 0.2
J	21		12.5 ± 0.2	21		27	21 ⁽¹⁾ 8.5 ⁽²⁾	21		27	± 0.5
K	9		9.6 ± 0.2	10.5		12	10.5 ± 0.3	14		12	± 0.5
L	15		18.7	16.5	24.5	29.5	19	20			± 0.5
M	5.3		3.5	5.3							± 0.1
N	6.3		3.9	6.3							± 0.1
Y	6			6							± 1
Z	140			140							+ 5

* Measurements share this common tolerance unless otherwise stated.

FRONT VIEW

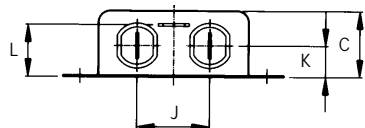

Housing F1, F2, G1
H1, H2, J1, K2

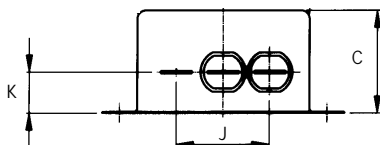

Housing J2

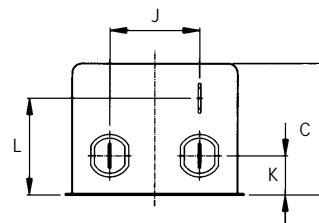

Housing K2

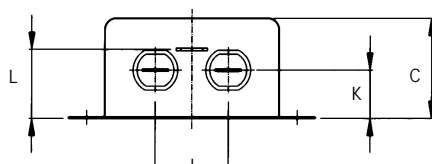

Housing J11

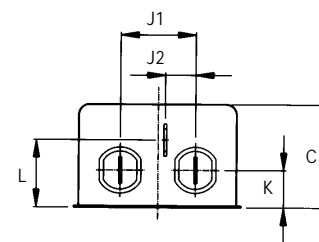

Housing H21, K1

TOP VIEW

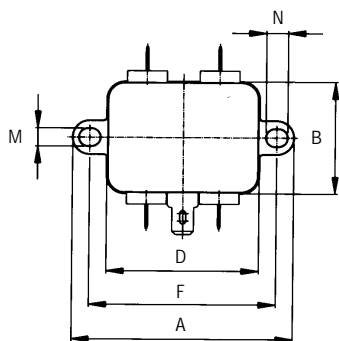

Housing F1, F2, G1

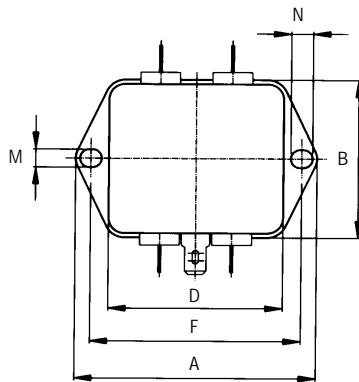

Housing H1, H2, J1, J11, J2

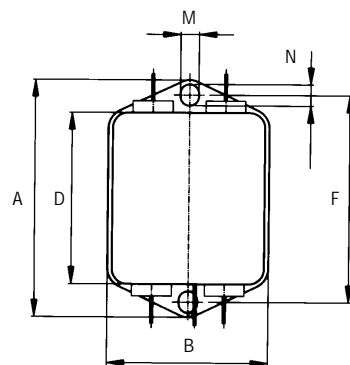

Housing H21, K1, K2, K21

Mechanical Data

SCHAFFNER

	FN 660-3-6 FN 250-6	FN ‡	FN 250-12	FN §	FN 682-10	FN 9675-16 FN 9676-16	FN 250-20	FN 350 -8-12-20	FN 350-30	Tol.* mm
	K1, K11	K2, K21	K22	L1	L2	L2	L4	L21	L21	
A	85		105		119		105		± 0.5	
B	54		99.5 ± 1		84.5 ± 1		99.5		± 0.5	
C	30	40		38	57		38	57	± 1	
D	65		84.5		98.5 ± 0.5		84.5		± 1	
E	75		79		66		79		± 0.5	
F	75		95		109		95		± 0.2	
G	51									± 0.1
J	27(J1) 8.5(J2) 17(J3)	27	17 (J3)	40						± 0.5
K	7	12		9.5	11		16	19	± 0.5	
L		29.5		19						± 0.5
M		5.3		4.4		4.4				± 0.1
N		6.3		6		7.5	6		± 0.1	
W	AWG 16		AWG 16			AWG 14				-
Y	6				6				± 1	
Z	300	140 + 5	300			300				+ 10

‡ FN 660-10-16, FN 670-1.8-3-6, FN 680-2.5, FN 682-4, FN 9675-3-6
§ FN 610-30, FN 612-30, FN 660-20, FN 670-10, FN 682-6.5

* Measurements share this common tolerance unless otherwise stated.

FRONT VIEW

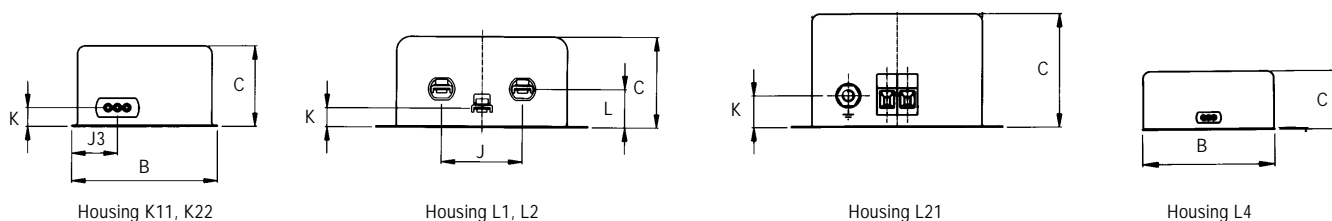

TOP VIEW

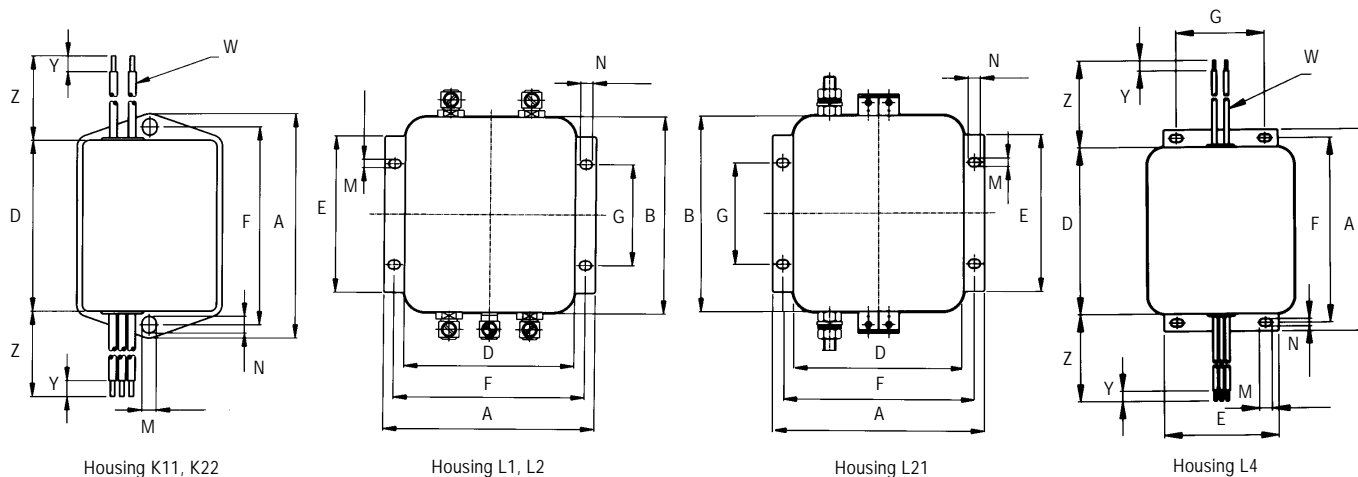

	FN 22 Housing KA1	FN 401-0.8 KA2	FN 401-1.5 KA3	FN 402-A-02 KA4	FN 405 KA4	FN 402-A-07 KB1	FN 402-A-16-38 KB2	Tol.* mm
A	25	49		45	36	43.5		± 0.5
B	25	24 ± 0.3	35 ± 0.3	28	31	45		± 0.5
C	25	16	27	16.5	19.5	16.5		± 0.5
D							28	± 0.5
E	15 ± 0.1	15	20	20	15	10 ± 1	7.5 ± 0.5	± 0.2
F	20	22.5	37.5	33	17.5	12 ± 1	7 ± 0.5	± 0.2
G	2.5 ± 0.1	2.5	5	0	0	34		± 0.2
H		6.25	7.5	10	7.5	24 ± 1	23 ± 0.5	± 0.2
J	∅0.6 ± 0.05	∅0.8		∅0.6	∅0.7	AWG 18		± 0.1
K		15	20	10	15	6.5 ± 0.5		± 0.2
M							∅6.5	± 0.1
N							∅3.1	± 0.1
Y	4	15	10	4	5.8	6	10 ± 1	± 0.5
Z							150	+ 5

* Measurements share this common tolerance unless otherwise stated.

SIDE VIEW

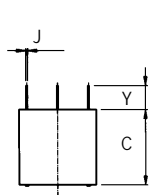

Housing KA1

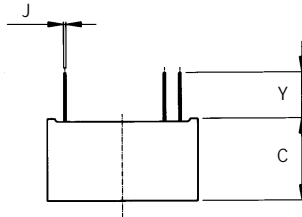

Housing KA2, KA3, KA4

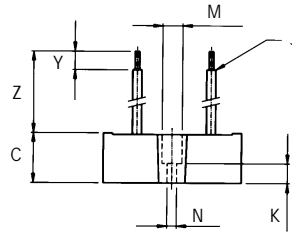

Housing KB1

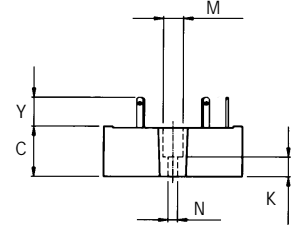

Housing KB2

BOTTOM VIEW

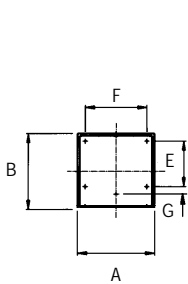

Housing KA1

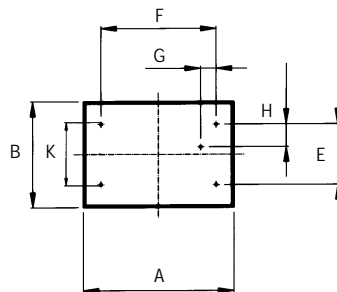

Housing KA2, KA3, KA4

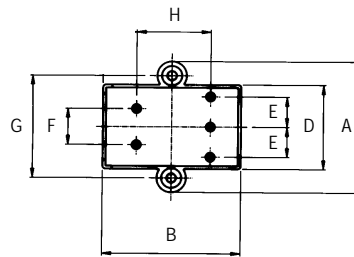

Housing KB1

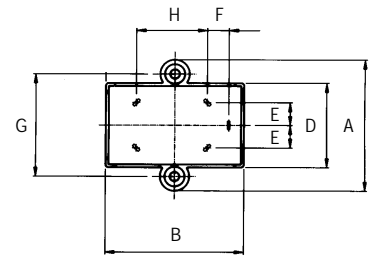

Housing KB2

Filter connections

These are the standard types of input and output connections available for Schaffner's range of filter families.

Schaffner can also produce filters with other popular output connectors, or user-specific interfaces, to custom order. Please call your local sales office to discuss any custom requirements.

Cross reference list
AWG to copper area in mm²

AWG number	Cu mm ² (approx)
22	0.33
20	0.54
18	0.83
16	1.34
14	2.15
12	3.44

1 inch = 25.4mm

Dimensions in mm

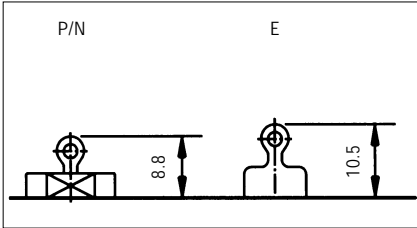

Type /01
Solder lug with a hole capable of accommodating several small wires

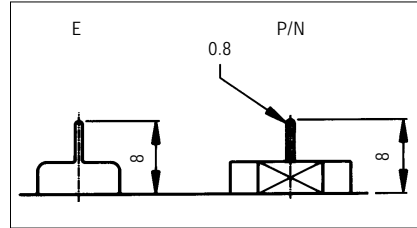

Type /02
Pin suitable for direct assembly onto through-hole printed-circuit boards

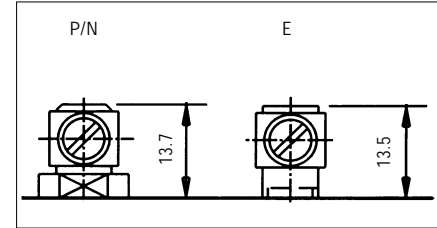

Type /03
Clamp terminal with M4 screw

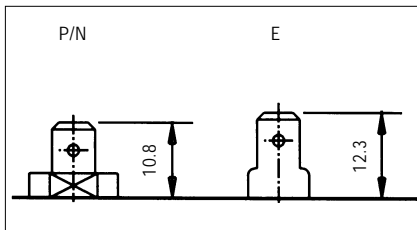

Type /05
Industry-standard size fast-on terminal, 6.3 x 0.8mm

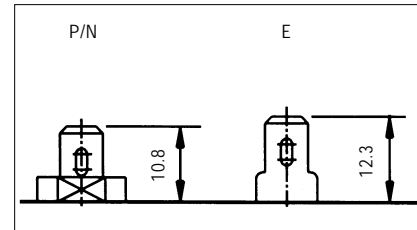

Type /06
Industry-standard size fast-on which may also be used as a solder lug, 6.3 x 0.8mm

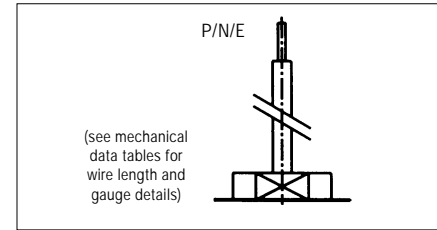

Type /07
Insulated wire, stripped ready for soldering. Wire gauge varies according to filter

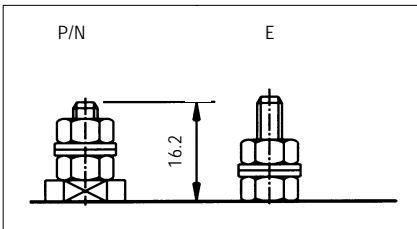

Type /08 = M4 screw
Type /09 = M5 screw
Type /10 = UNC 8-32 screw

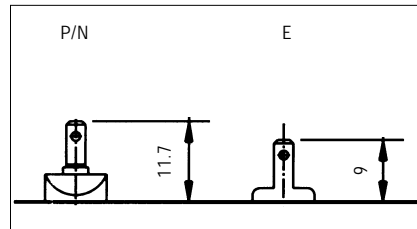

Type /13 = Fast-on, 2.8 x 0.5mm

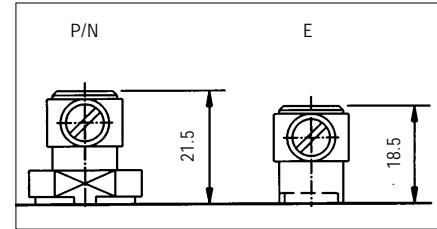

Type /23
Clamp terminal with M5 screw

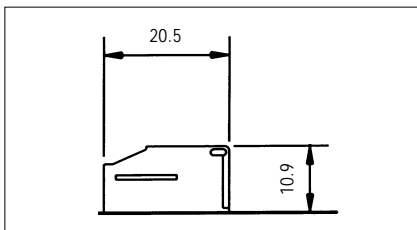

Type /29
Safety terminal block

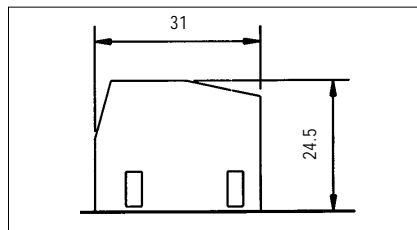

Type /33
Safety terminal block

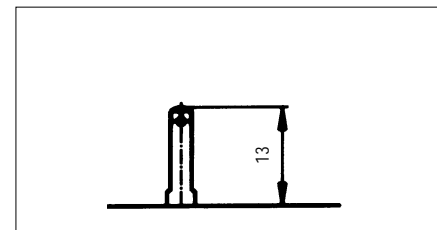

Type /16 = Solder/fast-on, 2.8 x 0.5mm
Type /38 = Fast-on, 2.8 x 0.8mm

Schaffner's worldwide sales, distribution and production network

HEADQUARTERS

Schaffner EMV AG
Nordstrasse 11
CH-4542 Luterbach
Switzerland
Tel: (032) 6816 626
Fax: (032) 6816 641

EUROLOGISTICS CENTER

Schaffner
1A, avenue de Suisse
F-68311 Illzach
France
Tel: (03) 89 31 04 00
Fax: (03) 89 31 04 01

FACTORIES

Schaffner EMV AG
Nordstrasse 11
CH-4542 Luterbach
Switzerland
Tel: (032) 6816 626
Fax: (032) 6816 641

Schaffner Ltd
National Technological Park
Castletroy
Limerick
Ireland
Tel: (061) 332233
Fax: (061) 332584

Schaffner EMC Co Ltd
67 Moo 4 Tambol Ban Klang
Amphur Muang PO Box 14
Lamphun 51000
Thailand
Tel: (053) 581 104
Fax: (053) 581 019

SALES SUBSIDIARIES

Schaffner Beijing Liaison Office
Room 911, Bright China Chang An Building
No. 7 Jianguomennei Dajie
Beijing 100005
China
Tel: (10) 6510 1761
Fax: (10) 6510 1763

Schaffner SA
43 rue Michel Carré
F-95103 Argenteuil
France
Tel: (01) 34 34 30 60
Fax: (01) 39 47 02 28

Rhone Alpes
F-38560 Champ sur Drac
Tel: (04) 76 68 64 00
Fax: (04) 76 68 63 70

Rennes
F-35510 Cesson-Sévigné
Tel: (02) 99 22 70 00
Fax: (02) 99 22 70 07

Schaffner EMV GmbH
Schoemperlenstrasse 12B
D-76185 Karlsruhe
Germany
Tel: (0721) 56 910
Fax: (0721) 56 9110

Northern Germany
D-59581 Warstein
Tel: (02902) 97 56 10
Fax: (02902) 97 56 80

Schaffner EMC Srl
Via Galileo Galilei, 47
I-20092 Cinisello Balsamo (MI)
Italy
Tel: (02) 66 04 30 45
Fax: (02) 61 23 943

Schaffner EMC KK
2-31-6 Kamiyama
Setagaya-Ku
Tokyo 154-0011
Japan
Tel: (03) 3418 5822
Fax: (03) 3418 3013

Schaffner EMC Pte Ltd
1200 Depot Road 06-01
Singapore 109675
Tel: 377 3283
Fax: 377 3281

Schaffner EMC AB
Turebergstorg 1,6
S-19147 Sollentuna
Sweden
Tel: (08) 5792 1121
Fax: (08) 929690

Schaffner Altrac AG
Mühlehaldestrasse 6
CH-8953 Dietikon
Switzerland
Tel: (01) 744 6111
Fax: (01) 744 6161

Schaffner EMC Ltd
Ashville Way
Molly Millar's Lane
Wokingham
Berks RG41 2PL
UK
Tel: (0118) 9770070
Fax: (0118) 9792969

Schaffner EMC Inc
9-B Fadem Road
Springfield, NJ 07081
USA
Toll free: 800 367 5566
Tel: (973) 379 7778
Fax: (973) 379 1151

West Coast
Irvine, CA 92718
Tel: (949) 457 9400
Fax: (949) 457 9510

DISTRIBUTORS

Austria
Eurodis Electronics GmbH Tel: 1 610 620

Belgium
SEI Belgium Tel: 2 456 0747

Czech Republic
Energo Praga Ltd. Tel: 2 6111 2665

Denmark
Avnet Nortec A/S Tel: 44 88 08 00

Finland
Electro Ferrum Oy Tel: 19 326 616

Germany
Spoerle Electronic Tel: 6103 3048

Greece
Micrelec Advanced Technologies Ltd.
Tel: 1 569 5043

Netherlands
SEI Benelux B.V. Tel: 76 57 22 500

Norway
Avnet Nortec A/S Tel: 66 77 36 00

Poland
Astat Sp. Tel: 61 8488 871

Spain
Selco S.A. Tel: 91 637 1011

Sweden
Avnet Nortec AB Tel: 8 629 1400

Turkey
Artest Elektronik Tel: 216 478 1757

Australia
Westek Industrial Products Pty Ltd.
Tel: 3 9369 8802

Brasil
Teknikao Ind e Com Ltda Tel: 11 3901 3741

Hong Kong
Denetron International Ltd. Tel: 2 707 9132

India
Vishal Agencies Tel: 40 711 2079

Israel
RDT Components Ltd. Tel: 3 645 0707

Japan
Nemic Lambda K.K. Tel: 3 3447 4411
SSR Engineering Co. Ltd. Tel: 3 3493 6613
Unidux Inc Tel: 4 2232 4500

Korea
Power EMC TEK Tel: 2 501 5852

New Zealand
MHS Technologies Ltd. Tel: 4 567 7016

Republic of South Africa
Arrow Altech Ltd. Tel: 11 923 9600

Taiwan
Bandtek International Co. Ltd. Tel: 2 2657 2615

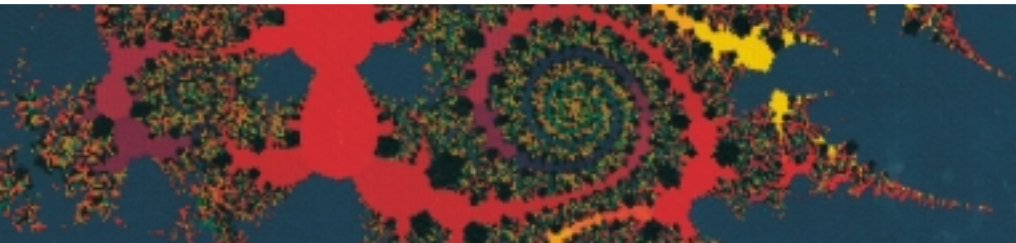

SCHAFFNER

Schaffner Elektronik AG CH-4542 Luterbach, Switzerland
Tel: [+41] (32) 6816 626 Fax: [+41] (32) 6816 641 www.schaffner.com



690-339H Benteli Hallwag/October 1998

© 1995 Schaffner Elektronik. Specifications subject to change without notice. All trademarks recognised.

 Schaffner is an ISO-registered company. Its products are designed and manufactured under the strict quality requirements of the ISO 9001 standard.

This document has been carefully checked. However, Schaffner does not assume any liability for errors or inaccuracies.