

FEATURES

AC PERFORMANCE

Small Signal Bandwidth: 80 MHz ($A_v = -1$)

Slew Rate: 450 V/ μ s

Full Power Bandwidth: 6.8 MHz at 20 V p-p,
 $R_L = 500 \Omega$

Fast Settling: for 10 V Step: 110 ns to 0.01%,
80 ns to 0.1%

Differential Gain: <0.01% @ 4.4 MHz

Differential Phase: <0.028° @ 4.4 MHz

Total Harmonic Distortion (THD): 0.0005% @ 100 kHz

Open-Loop Transimpedance: 200 M Ω

Input Voltage Noise: 2 nV/ $\sqrt{\text{Hz}}$

DC PERFORMANCE

Input Offset Voltage: 75 μ V max (B Grade)

Input Offset Drift: 3.5 μ V/ $^{\circ}$ C max (B Grade)

Quiescent Supply Current: 6.5 mA max

APPLICATIONS

High Speed DAC Buffers

Multiflash ADC Error Amplifiers

Flash ADC Buffers

Coaxial Cable Drivers

High Performance Audio Circuitry

Available in Plastic Mini-DIP, Hermetic Cerdip, and

Hermetic Metal Can Packages

MIL-STD-883B Parts Available

PRODUCT DESCRIPTION

The AD846 is a monolithic, very high speed operational amplifier offering high performance. Although technically classed as a current-feedback or transimpedance amplifier, it may be used in much the same way as traditional op amps while providing significant performance benefits. Employing Analog Devices' junction isolated complementary bipolar (CB) process, the AD846 achieves true "12-bit" (0.01%) precision on critical ac and dc parameters, a level of performance unmatched by amplifiers fabricated using either the dielectrically isolated (DI) or other bipolar processes.

The AD846 offers significant advantages over conventional high speed operational amplifiers. It maintains a nearly constant bandwidth and settling time to 0.01% over a wide range of closed-loop gains. This makes the AD846 ideal for amplifying the residue in multiple-pass analog-to-digital converters.

REV. B

Information furnished by Analog Devices is believed to be accurate and reliable. However, no responsibility is assumed by Analog Devices for its use, nor for any infringements of patents or other rights of third parties which may result from its use. No license is granted by implication or otherwise under any patent or patent rights of Analog Devices.

CONNECTION DIAGRAM

Plastic Mini-DIP (N) Package
and
Cerdip (Q) Package

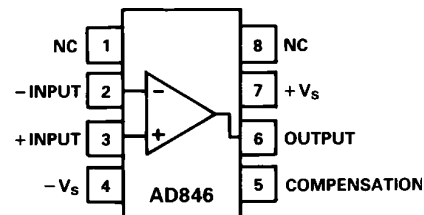

NC = NO CONNECT

TOP VIEW

Other advantages include: low input errors and high open-loop transresistance (200 M Ω) into a 500 Ω load, ensuring true 12-bit dc accuracy for closed-loop gains from -1 to gains greater than -100. This combination of ac and dc performance makes the AD846 an excellent choice for buffering precision high speed DACs and flash ADCs.

The AD846 is available in three performance grades. The AD846A and AD846B are rated over the industrial temperature range of -40 $^{\circ}$ C to +85 $^{\circ}$ C. The AD846S is rated over the full military temperature range of -55 $^{\circ}$ C to +125 $^{\circ}$ C and is available processed to MIL-STD-883B, Rev C.

Extended reliability PLUS screening is available specified over the commercial temperature range. PLUS screening includes 168 hour burn-in as well as other environmental and physical tests. The AD846 is available in two types of 8-pin package: plastic mini-DIP and hermetic cerdip. "A" and "S" grade chips are also available.

PRODUCT HIGHLIGHTS

1. The AD846 achieves settling times of 110 ns to 0.01% for gains of -1 to -10, with a 450 V/ μ s slew rate, while consuming only 5 mA of supply current.
2. For closed-loop gains of -1 to -100, the high speed performance of the AD846 is achieved without sacrificing full 12-bit dc precision.
3. The AD846 is well suited to line driver and video buffer applications where the properties of low distortion and high slew rate are required.

AD846—SPECIFICATIONS (@ +25°C and ±15 V dc, unless otherwise noted)

Model	Conditions	AD846A			AD846B			AD846S			Units
		Min	Typ	Max	Min	Typ	Max	Min	Typ	Max	
INPUT OFFSET VOLTAGE¹											
Initial			25	200		25	75		25	200	μV
$T_{MIN} - T_{MAX}$			50	350		50	125		100	350	μV
vs. Temperature			0.8	5		0.8	3.5		1	5.5	μV/°C
vs. Supply (PSRR)	5 V–18 V ²										
Initial		110	125		120	125		110	125		dB
$T_{MIN} - T_{MAX}$		110	120		116	120		94	116		dB
vs. Common Mode (CMRR)	$V_{CM} = \pm 10$ V										
Initial		110	125		120	125		110	125		dB
$T_{MIN} - T_{MAX}$		110	120		116	120		94	116		dB
INPUT BIAS CURRENT³											
–Input Bias Current											
Initial			150	450		100	250		150	450	nA
$T_{MIN} - T_{MAX}$			450	1200		400	750		1000	1500	nA
vs. Temperature			6	20		6	17		9	20	nA/°C
vs. Supply	5 V–18 V ²										
Initial			9	15		9	10		9	15	nA/V
$T_{MIN} - T_{MAX}$			11	20		11	15		11	25	nA/V
vs. Common Mode	$V_{CM} = \pm 10$ V										
Initial			5	10		3	5		5	10	nA/V
$T_{MIN} - T_{MAX}$			5	15		3	7		5	20	nA/V
+Input Bias Current											
Initial			3	15		3	5		3	15	μA
$T_{MIN} - T_{MAX}$			4	20		4	7		5	20	μA
vs. Temperature			15	80		15	45		15	80	nA/°C
vs. Supply	5 V–18 V ²										
Initial			5	15		5	10		5	15	nA/V
$T_{MIN} - T_{MAX}$			5	20		5	15		5	20	nA/V
vs. Common Mode	$V_{CM} = \pm 10$ V										
Initial			5	15		3	10		5	15	nA/V
$T_{MIN} - T_{MAX}$			5	15		3	10		5	20	nA/V
INPUT CHARACTERISTICS											
Input Resistance											
–Input			50			50			50		Ω
+Input			10			10			10		kΩ
Input Capacitance											
–Input			2			2			2		pF
+Input			2			2			2		pF
INPUT VOLTAGE RANGE											
Common Mode			±10			±10			±10		V
INPUT VOLTAGE NOISE											
F = 1 kHz											
Input Current Noise											
–Input	1 kHz		20			20			20		pA/√Hz
+Input	1 kHz		6			6			6		pA/√Hz
OPEN LOOP											
TRANSRESISTANCE											
	$V_{OUT} = \pm 10$ V										
	$R_{LOAD} = 500$ Ω		100	200		150	200		100	200	MΩ
	$T_{MIN} - T_{MAX}$		50			75			50		MΩ
OUTPUT CHARACTERISTICS											
$R_{LOAD} = 500$ Ω											
Voltage			±10			±10			±10		V
Current	Short Circuit		65			65			65		mA
Output Resistance	Open Loop		16			16			16		Ω
FREQUENCY RESPONSE											
Small Signal Bandwidth (–3 dB)											
	$A_V = -1$ $R_F = 1$ k		80			80			80		MHz
	$A_V = -10$ $R_F = 875$ Ω		31			31			31		MHz
	$A_V = -30$ $R_F = 875$ Ω		15			15			15		MHz
Full Power Bandwidth ⁴											
	$V_{OUT} = 20$ V p-p										
	$R_I = 500$ Ω		6.8			6.8			6.8		MHz
Rise Time	$A_V = -1$		110			10			10		ns
Overshoot	$A_V = -1$		20			20			20		%
Slew Rate	$A_V = -1$		450			450			450		V/μs
Settling Time											
10 V Step, $A_V = -1$	to 0.1%		80			80			80		ns
	to 0.01%		110			110			110		ns
TOTAL HARMONIC DISTORTION⁵											
	F = 100 kHz		0.0005			0.0005			0.0005		%

Model	Conditions	AD846A			AD846B			AD846S			Units
		Min	Typ	Max	Min	Typ	Max	Min	Typ	Max	
DIFFERENTIAL GAIN	F = 4.4 MHz, R _L = 100 Ω	0.01			0.01			0.01			%
DIFFERENTIAL PHASE	F = 4.4 MHz, R _L = 100 Ω	0.028			0.028			0.028			Degrees
POWER SUPPLY											
Rated Performance			±15			±15		±15			V
Operating Range		±5		±18	±5		±18	±5		±18	V
Quiescent Current	T _{MIN} -T _{MAX}		5	6.5		5	6.5		5	7	mA
TRANSISTOR COUNT		72			72			72			

NOTES

¹Input Offset Voltage Specifications are guaranteed after 5 minutes at T_A = +25°C.

²Test Conditions: +V_S = 15 V, -V_S = 5 V to 18 V and +V_S = 5 V to 18 V, -V_S = 15 V.

³Bias Current Specifications are guaranteed maximum after 5 minutes at T_A = +25°C.

⁴FPBW = Slew Rate/2 π V_{PEAK}.

⁵Total Harmonic Distortion.

All min and max specifications are guaranteed. Specifications shown in **boldface** are tested on all production units at final electrical test. Results from those tests are used to calculate outgoing quality levels.

Specifications subject to change without notice.

ABSOLUTE MAXIMUM RATINGS¹

Supply Voltage ±18 V

Internal Power Dissipation²

Plastic Package 1.5 W

Cerdip Package 1.3 W

Common-Mode Input Voltage, Max Safe |V_S| - 3 V

Output Short Circuit Duration Indefinite

Differential Input Voltage ±1 V

Continuous Input Current

Inverting or Noninverting 2.0 mA

Storage Temperature Range (Q) -65°C to +150°C

Storage Temperature Range (N) -65°C to +125°C

Operating Temperature Range

AD846A/B -40°C to +85°C

AD846S -55°C to +125°C

Lead Temperature Range (Soldering 60 sec) +300°C

ESD Rating 3500 V

NOTES

¹Stresses above those listed under "Absolute Maximum Ratings" may cause permanent damage to the device. This is a stress rating only; the functional operation of the device at these or any other conditions above those indicated in the operational sections of this specification is not implied. Exposure to absolute maximum rating conditions for extended periods may affect device reliability.

²Maximum internal power dissipation is specified so that T_J does not exceed +175°C at an ambient temperature of +25°C, derate cerdip (Q) package at 8.7 mW/°C and plastic (N) package at 10 mW/°C.

Plastic Package: θ_{JA} = 100°C/Watt, θ_{JC} = 33°C/W.

Cerdip Package: θ_{JA} = 110°C/Watt, θ_{JC} = 30°C/W.

ORDERING GUIDE

Model ¹	Temperature Range	Package Option ²
AD846AN	-40°C to +85°C	N-8
AD846BN	-40°C to +85°C	N-8
AD846AQ	-40°C to +85°C	Q-8
AD846BQ	-40°C to +85°C	Q-8
AD846SQ	-55°C to +125°C	Q-8
AD846SQ/883B	-55°C to +125°C	Q-8
5962-8964601PA	-55°C to +125°C	Q-8

NOTES

¹"A" and "S" grade chips are also available.

²N = Plastic DIP Package; Q = Cerdip Package.

METALIZATION PHOTOGRAPH

Dimensions shown in inches and (mm).

Consult factory for latest dimensions.

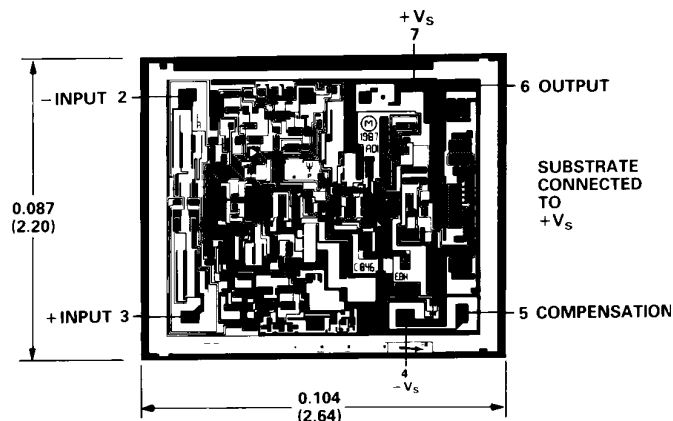

AD846—Typical Characteristics

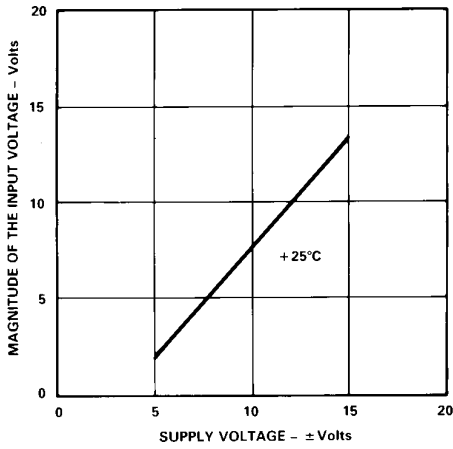

Figure 1. Input Voltage Swing vs. Supply

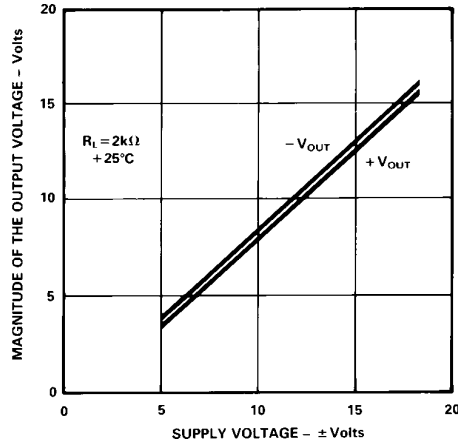

Figure 2. Output Voltage Swing vs. Supply

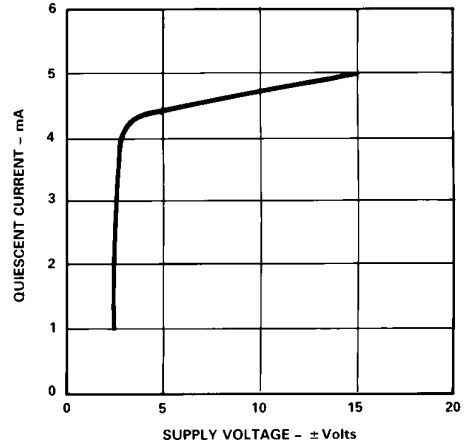

Figure 3. Quiescent Current vs. Supply Voltage

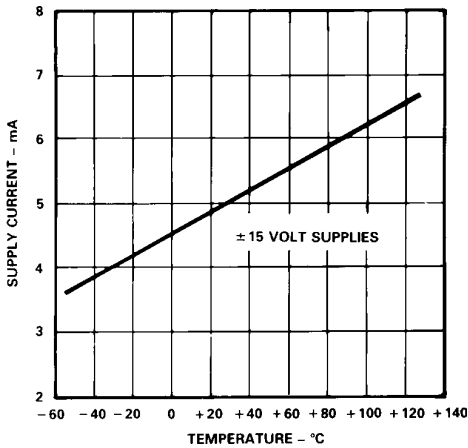

Figure 4. Quiescent Supply Current vs. Temperature

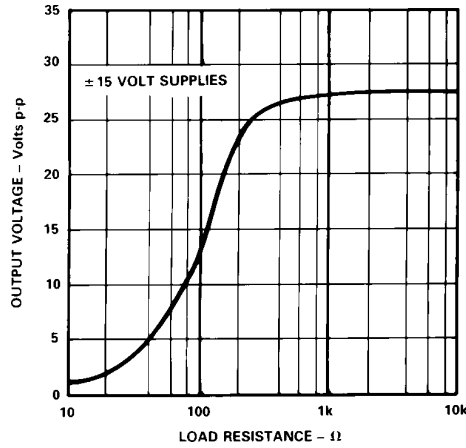

Figure 5. Output Voltage Swing vs. Resistive Load

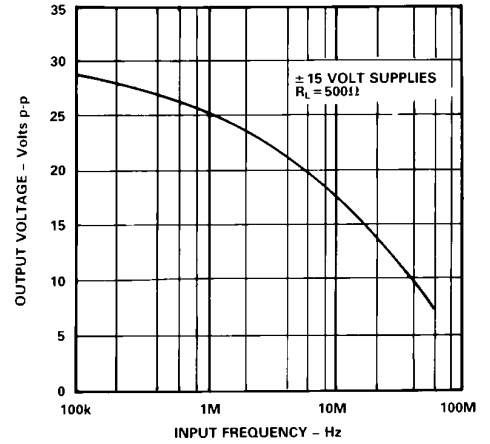

Figure 6. Large Signal Frequency Response

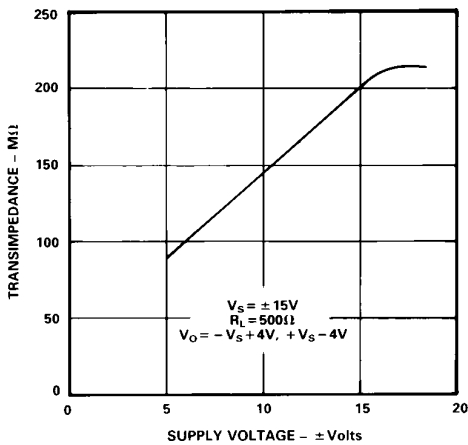

Figure 7. Open-Loop Transimpedance vs. Supply

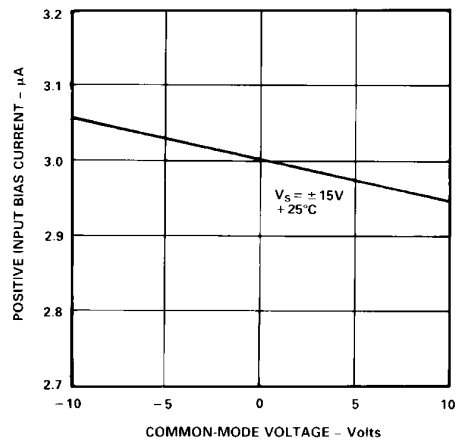

Figure 8. Positive Input Bias Current vs. Common-Mode Voltage

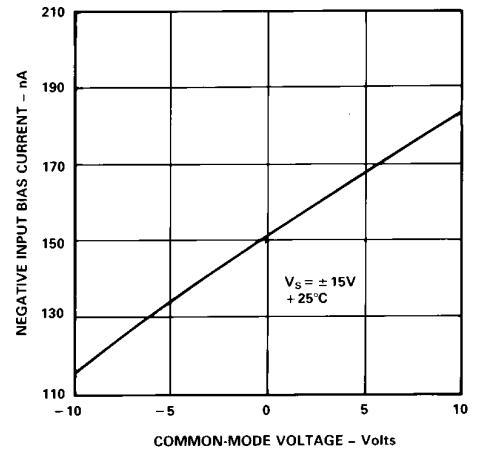

Figure 9. Negative Input Bias Current vs. Common-Mode Voltage

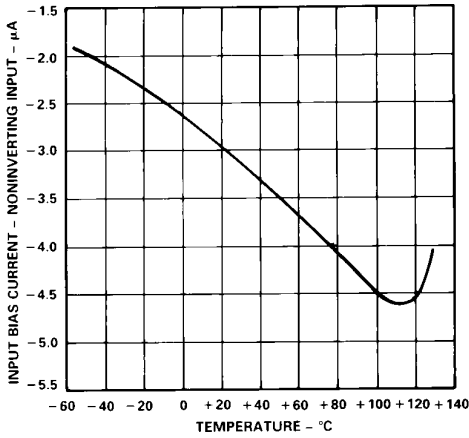

Figure 10. Positive Input Bias Current vs. Temperature

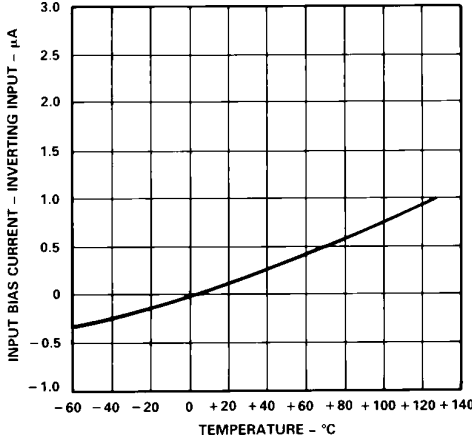

Figure 11. Negative Input Bias Current vs. Temperature

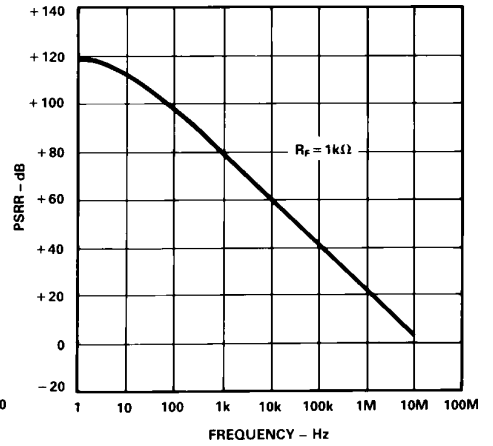

Figure 12. Power Supply Rejection vs. Frequency

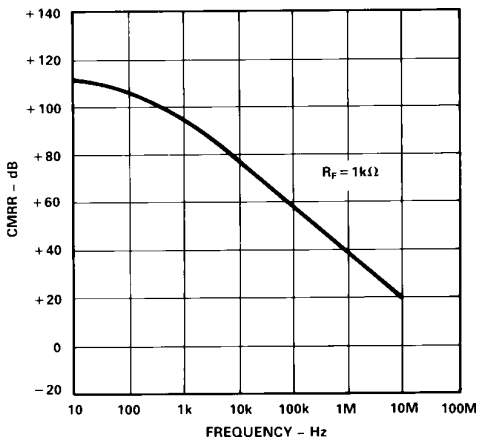

Figure 13. Common-Mode Rejection vs. Frequency

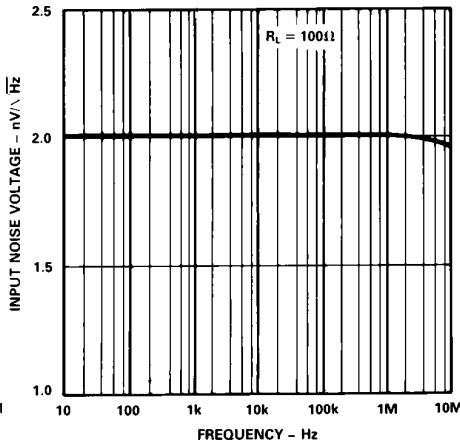

Figure 14. Input Noise Voltage Spectral Density

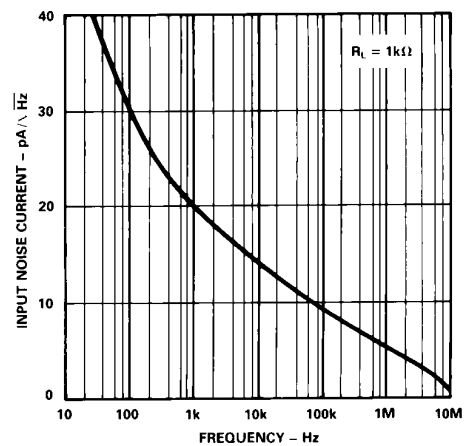

Figure 15. Inverting Input Noise Current Spectral Density

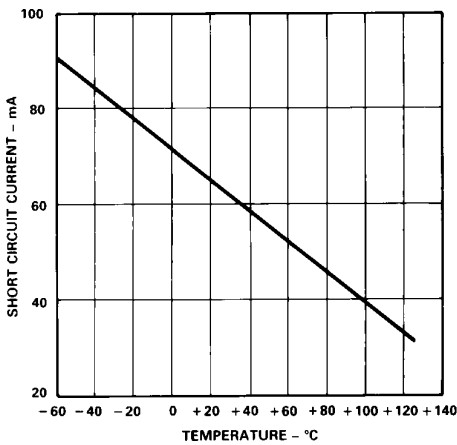

Figure 16. Short Circuit Current Limit vs. Temperature

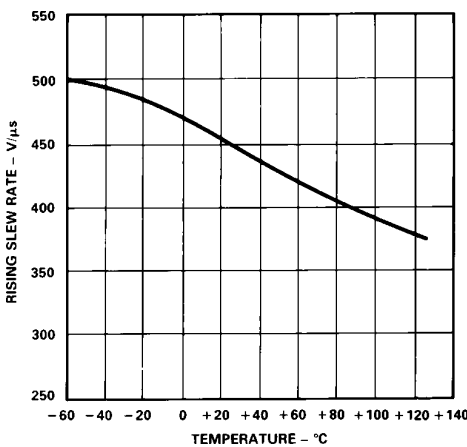

Figure 17. Slew Rate vs. Temperature

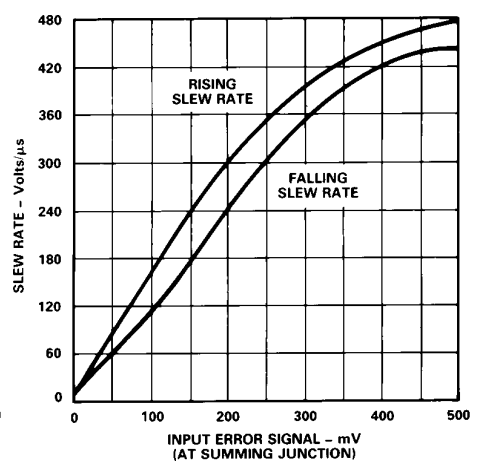

Figure 18. Slew Rate vs. Input Error Signal

AD846—Typical Characteristics, Inverting Gain of 1

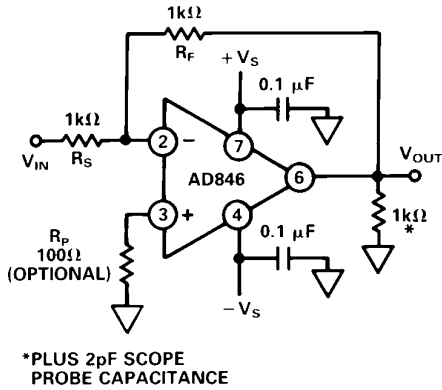

Figure 19a. Inverting Amplifier, Gain of 1

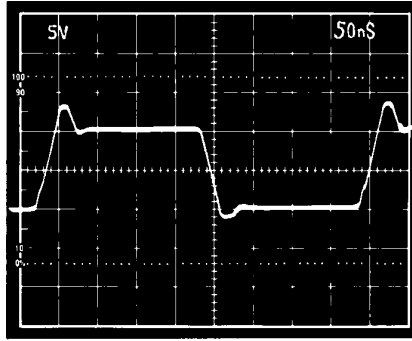

Figure 19b. Large Signal Pulse Response, Gain of -1

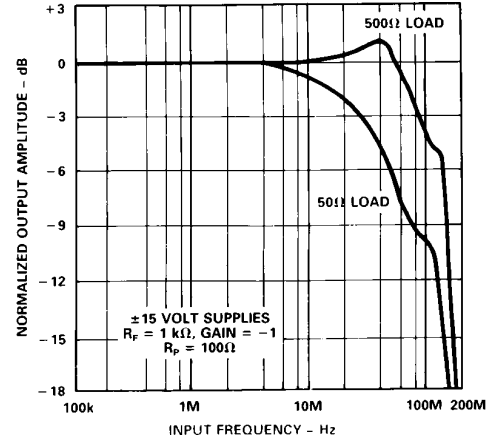

Figure 20. Normalized Output Amplitude vs. Frequency vs. Load

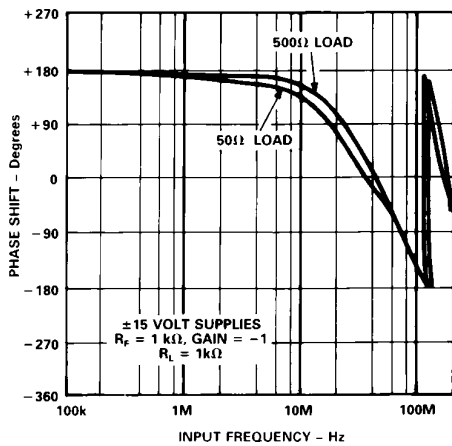

Figure 21. Phase Shift vs. Frequency

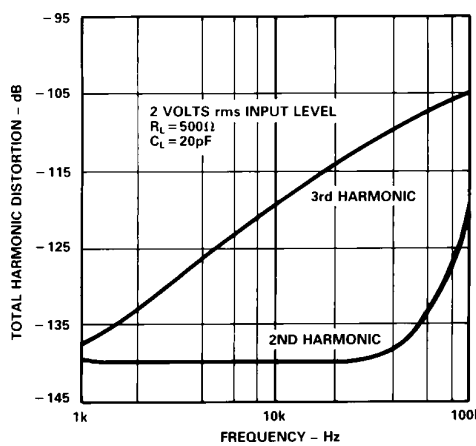

Figure 22. Total Harmonic Distortion vs. Frequency

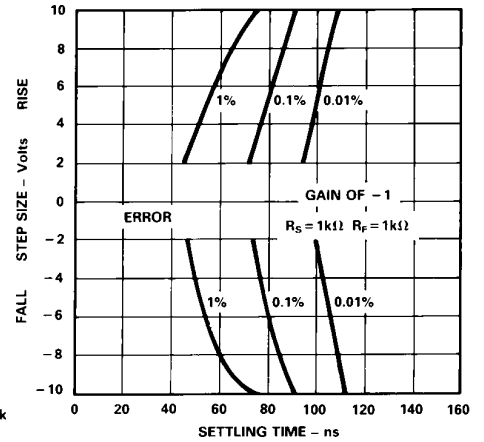

Figure 23. Settling Time vs. Step Size

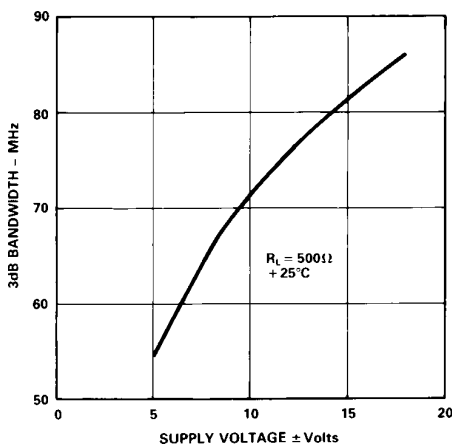

Figure 24. 3 dB Bandwidth vs. Supply Voltage

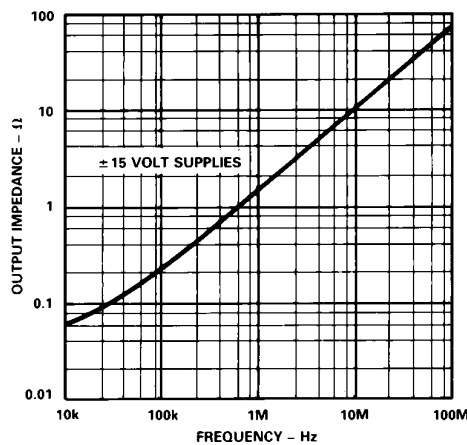

Figure 25. Output Impedance vs. Frequency

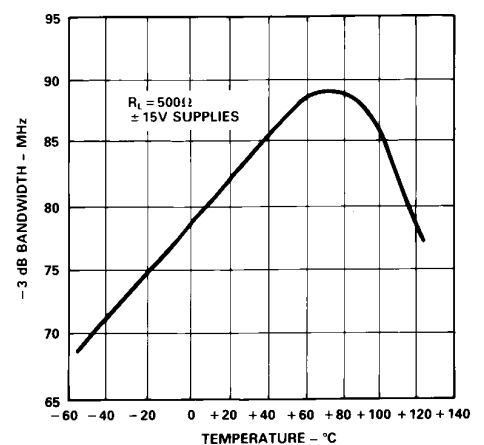

Figure 26. -3 dB Bandwidth vs. Temperature

Typical Characteristics, Inverting Gain of 10-AD846

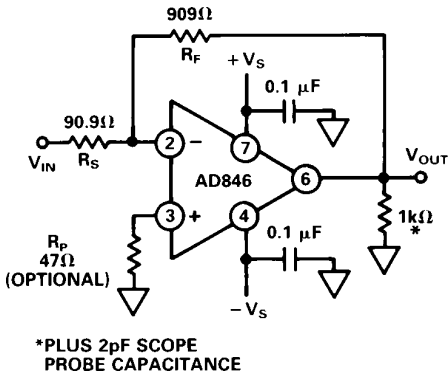

Figure 27a. Inverting Amplifier, Gain of 10

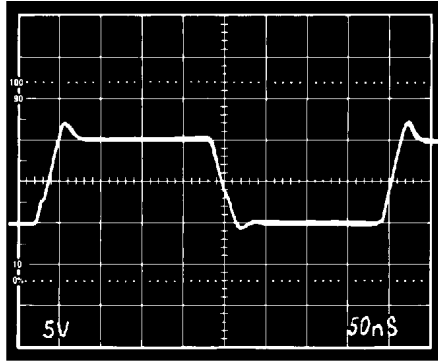

Figure 27b. Large Signal Pulse Response, Gain of 10

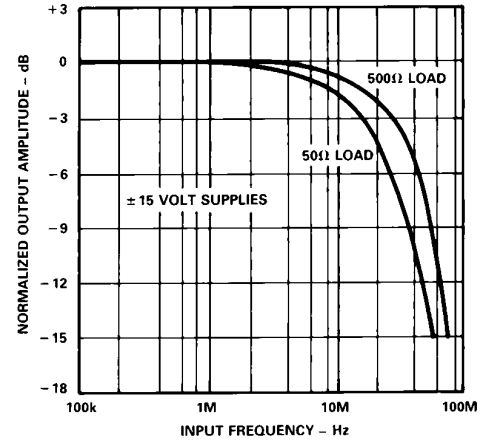

Figure 28. Normalized Output Amplitude vs. Frequency vs. Load

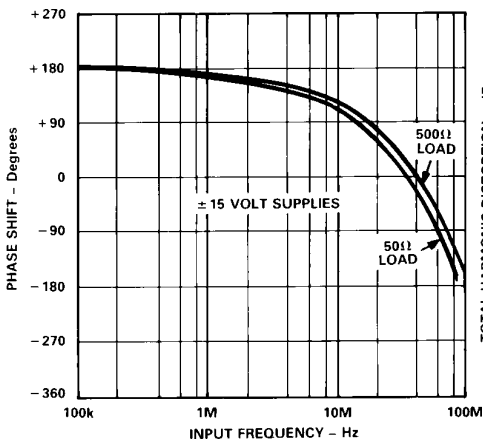

Figure 29. Phase vs. Frequency vs. Load

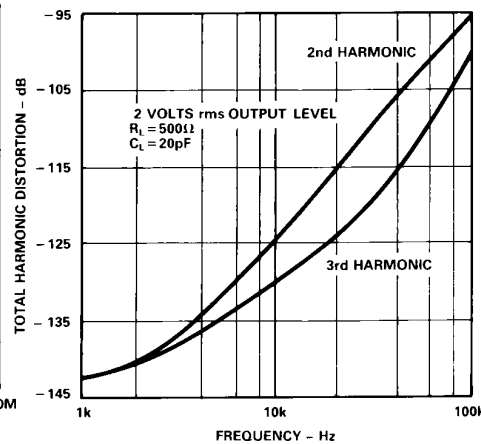

Figure 30. Harmonic Distortion vs. Frequency

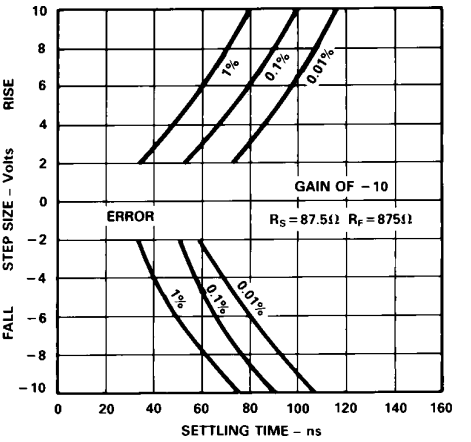

Figure 31. Settling Time vs. Step Size

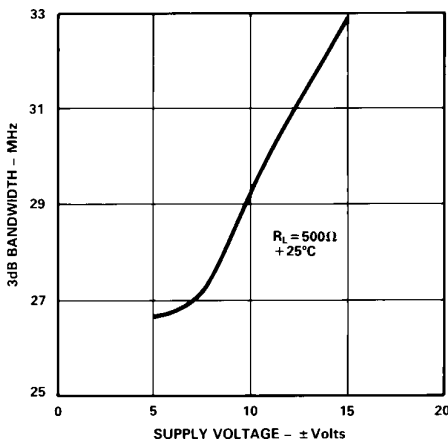

Figure 32. 3 dB Bandwidth vs. Supply Voltage

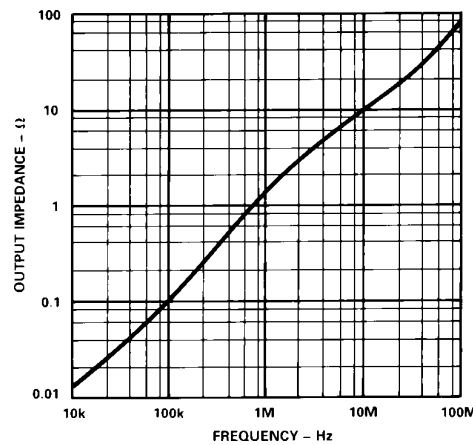

Figure 33. Output Impedance vs. Frequency

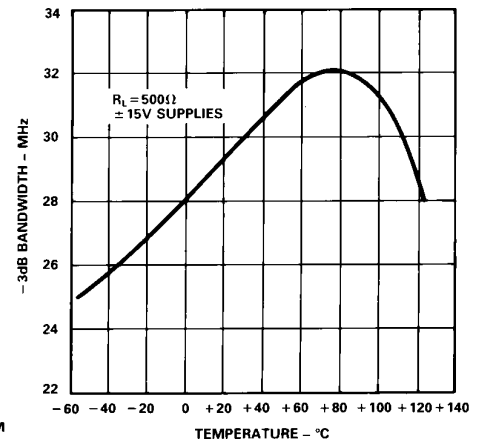

Figure 34. -3 dB Bandwidth vs. Temperature

AD846

POWER SUPPLY CONSIDERATIONS

The power supply connections to the AD846 must maintain a low impedance to ground over a bandwidth of 40 MHz or more. This is especially important when driving a significant resistive or capacitive load, since all current delivered to the load comes from the power supplies. Multiple high quality bypass capacitors are recommended for each power supply line in any critical application. A 0.1 μF ceramic and a 2.2 μF electrolytic capacitor as shown in Figure 35 placed as close as possible to the amplifier (with short lead lengths to power supply common) will assure adequate high frequency bypassing, in most applications. A minimum bypass capacitance of 0.1 μF should be used for any application.

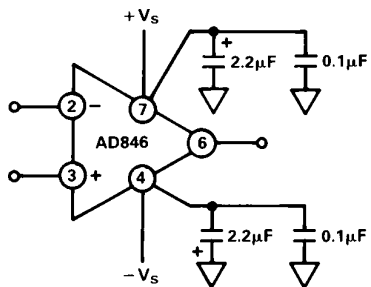

Figure 35. Recommended Power Supply Bypassing

THEORY OF OPERATION

The AD846 differs from conventional operational amplifiers in that it is a transimpedance device rather than a conventional voltage amplifier. Figure 36 is a simplified schematic of the AD846. The input stage consists of a pair of transistors, Q1 and Q2, which are biased by two diode-connected transistors, Q3 and Q4. Transistors Q1 and Q2 have their emitters connected together, and this common point functions as the inverting input of the amplifier. Correspondingly, the common connection of the two biasing diodes acts as the noninverting input.

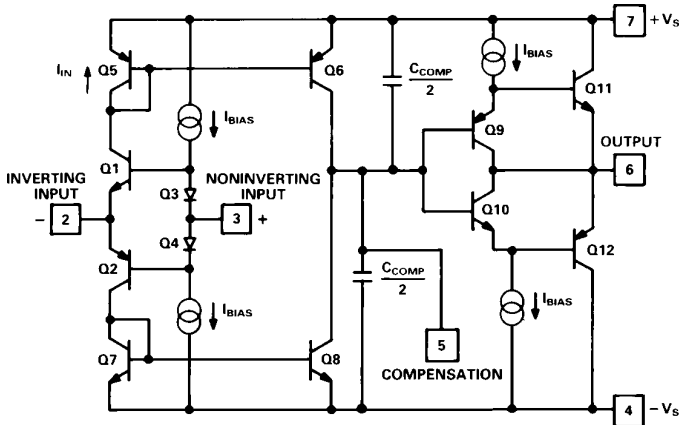

Figure 36. AD846 Simplified Schematic

When operated as a closed-loop amplifier, feedback error current, I_{IN} , flows into the inverting input terminal and is conveyed via current mirrors (transistors Q5, Q6, Q7, and Q8) to the compensation capacitor, C_{COMP} . The voltage developed across C_{COMP} is buffered by the output stage, consisting of transistors Q9–Q12.

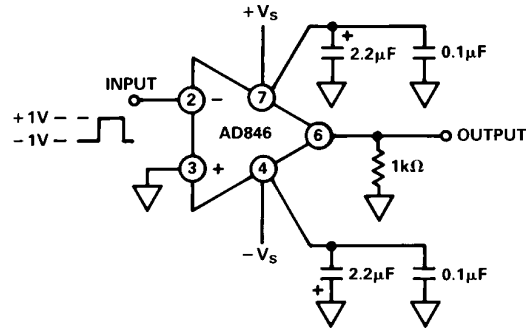

Figure 37. Overload Recovery Test Circuit

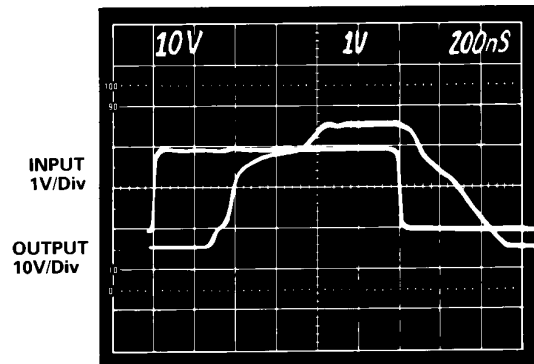

Figure 38. Overload Recovery Time Photo

Because the input error signal developed is in the form of a current, not a voltage, the AD846 differs from conventional operational amplifiers. This also means that, unlike most operational amplifiers which rely on negative feedback to produce a “virtual ground” at the inverting input terminal, this terminal explicitly has a low impedance.

A unique circuit approach allows the AD846 to realize an open-loop transimpedance of close to 200 M Ω . This is nearly three orders of magnitude greater than that of any other operational transimpedance amplifier and results in extremely high levels of dc precision.

As an example, the output voltage gain error is approximately equal to the value of the feedback resistor divided by the value of the open-loop transimpedance of the amplifier. That is, when using a 1 k Ω feedback resistor, this error is one part in 200,000. For a transimpedance amplifier with 1 M Ω transimpedance, this error is only one part in 1000; such an amplifier would barely be able to achieve 10-bit precision.

Figure 39 is a simplified three-terminal model for the AD846. Figure 40 is a simplified three-terminal model for a conventional voltage op amp. The action of current feedback serves to modify the behavior of the amplifier under closed-loop conditions. The feedback resistor, R_F , is somewhat analogous to the input stage transconductance of a conventional voltage amplifier; and therefore, if the value of R_F is held constant, the closed-loop bandwidth also remains virtually constant, independent of closed-loop voltage gain.

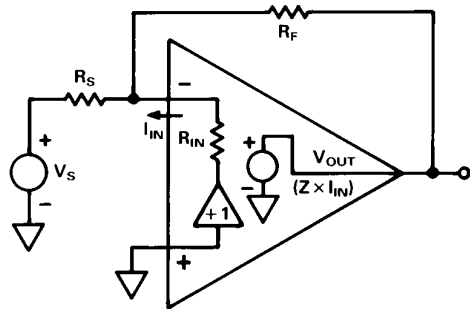

Figure 39. AD846 Three-Terminal Model

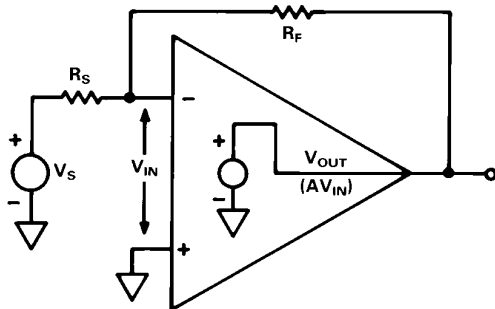

Figure 40. Op Amp Three-Terminal Model

A more detailed examination of the closed-loop transfer function of the AD846 results in the following equation:

$$\text{Closed-Loop Gain } G(s) = \frac{-R_F/R_S}{1 + C_{COMP} \left[R_F + \left(1 + \frac{R_F}{R_S} \right) R_{IN} \right] s}$$

Compare this to the equation for a conventional op amp:

$$\text{Closed-Loop Gain } G(s) = \frac{-R_F/R_S}{1 + \frac{C_{COMP}}{g_M} \left(1 + \frac{R_F}{R_S} \right) s}$$

where: C_{COMP} is the internal compensation capacitor of the amplifier; g_M is the input stage transconductance of the amplifier.

In the case of the voltage amplifier, the closed-loop bandwidth decreases directly with increasing values of $(1 + R_F/R_S)$, the closed-loop gain. However, for the transimpedance amplifier, the situation is different. At low gains, where $(1 + R_F/R_S) R_{IN}$ is small compared to R_F , the closed-loop bandwidth is controlled by the internal compensation capacitance of 7 pF and the value of R_F , and not by the closed-loop gain. At higher gains, where $(1 + R_F/R_S) R_{IN}$ is much larger than R_F , the behavior is that of a conventional operational amplifier in which the input stage transconductance is equal to the inverting terminal input impedance of the transimpedance amplifier ($R_{IN} = 50 \Omega$).

A simple equation can, therefore, be used to determine the bandwidth of an amplifier employing the AD846 in the inverting configuration.

$$3 \text{ dB Bandwidth} = \frac{23}{R_F + 0.05 (1 + G)}$$

where: The 3 dB bandwidth is in MHz

G is the closed-loop inverting gain of the AD846

R_F is the feedback resistance in k Ω .

NOTE: This equation applies only for values of R_F between 10 k Ω and 100 k Ω , and for R_{LOAD} greater than 500 Ω . For $R_F = 1 \text{ k}\Omega$ the bandwidth should be estimated from Figure 41.

Figure 41 illustrates the closed-loop voltage gain vs. frequency of the AD846 for various values of feedback resistor. For comparison purposes, the characteristic of a conventional amplifier having an 80 MHz unity gain bandwidth is also shown.

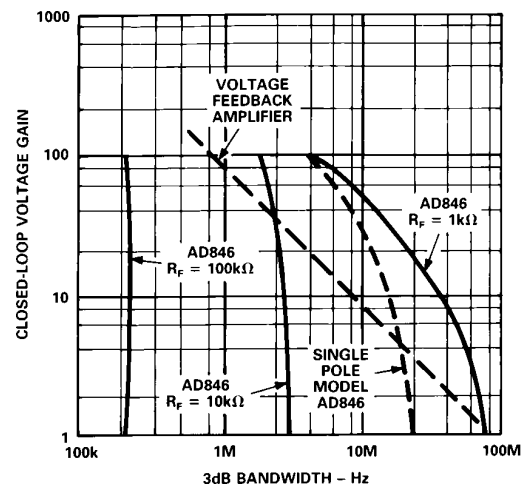

Figure 41. Closed-Loop Voltage Gain vs. Bandwidth for Various Values of R_F

For the case where $R_F = 1 \text{ k}\Omega$ and $R_S = 100 \Omega$ (closed-loop gain of -10), the closed-loop bandwidth is approximately 28 MHz. It should also be noted that the use of a capacitor to shunt R_F , a normal practice for stabilizing conventional op amps, will cause this amplifier to become unstable because the closed-loop bandwidth will increase beyond the stable operating frequency.

A similar approach can be taken to calculate the noise performance of the amplifier. A simplified noise model is shown in Figure 42.

The equivalent mean-square output noise voltage spectral density will equal:

$$V_{ON}^2 = (R_F I_{NN})^2 + \left(1 + \frac{R_F}{R_S} \right)^2 [V_N^2 + (R_P I_{NP})^2 + 4 kT R_P] + 4 kT R_F \left(\frac{R_F}{R_S} + 1 \right)$$

AD846

Where:

- R_P is the external resistance placed in series with the non-inverting input
- R_F is the feedback resistor
- R_S is the source resistor
- I_{NN} is the noise current in the inverting input
- I_{NP} is the noise current in the noninverting input
- V_N is the input noise voltage.

Typical values for these parameters (@ 1 kHz) in $\text{pA}/\sqrt{\text{Hz}}$ are: $I_{NN} = 20$, $I_{NP} = 6$, $V_N = 2$.

Or, referring to the signal input, the equivalent mean-square input voltage noise is:

$$V_{IN}^2 = (R_F I_{NN})^2 + \left(1 + \frac{R_S}{R_F}\right)^2 \left[V_N^2 + (R_P I_{NP})^2 + 4 kT R_P \right] + 4 kT R_S \left(1 + \frac{R_S}{R_F}\right)$$

Resistor R_P is required for both inverting and noninverting (follower) operation, to insure stable operation. The amplifier's noninverting input current (flowing through R_P of 100 Ω) will typically add less than 300 μV to the AD846's input offset voltage. This can be trimmed-out using the optional network shown in Figure 44. The following table gives recommended values for R_P .

Supply Voltage	Gain (R_F/R_S)	Recommended Value for R_P
6 V to 15 V	1-10	100 Ω
6 V to 15 V	10-20	47 Ω
6 V to 15 V	20-200	0 Ω
5 V	1-10	47 Ω
5 V	10-200	0 Ω

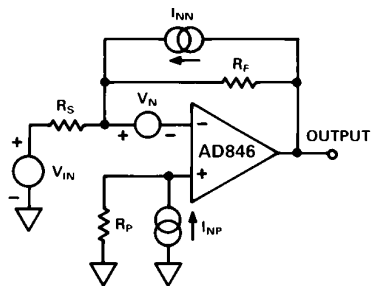

Figure 42. Op Amp Simplified Noise Model

NONINVERTING GAIN OPERATION

The AD846 can be used as a noninverting amplifier or voltage follower, operating at gains between 1 and 200. A minimum value of R_F equal to 1 k Ω should be employed. For low gains (1 to 2), the input signal should be applied to the AD846's noninverting input through a 100 Ω series resistor; this will help reduce peaking. The best transient response will occur when the amplifier's output level is below 5 V peak to peak.

At closed-loop gains of 3 or more, the input resistor is not required unless peak signals greater than 3 V will be applied. The amplifier's bandwidth can be determined by using the inverting amplifier's bandwidth equation or from Figure 41. For example, at a gain of +10 ($R_F = 1 \text{ k}\Omega$, $R_S = 100 \Omega$) the bandwidth of the AD846 will be approximately 33 MHz; at a gain of +100,

($R_F = 1 \text{ k}\Omega$, $R_S = 10 \Omega$) it will be 4 MHz. At gains of 3 or greater, a small capacitor (2 pF-5 pF) connected across the feedback resistor will help reduce overshoot; but when operating at noninverting gains below 3, this same capacitance will cause instability.

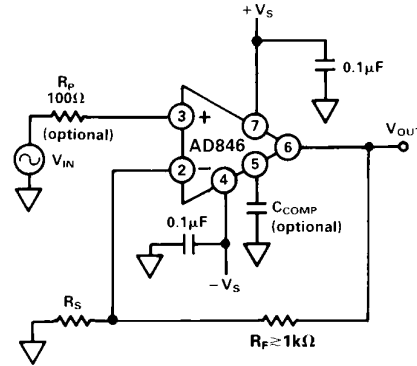

Figure 43. AD846 Noninverting Amplifier Configuration

USING THE COMPENSATION PIN OF THE AD846

Additional compensation may be provided for the AD846 by applying an external capacitance between Pin 5 and analog ground (Figure 44). The nominal value of the AD846's internal compensation capacitor is 7 pF. For a given value of feedback resistance (R_F), any added external capacitance reduces the amplifier's slew rate and bandwidth proportionally.

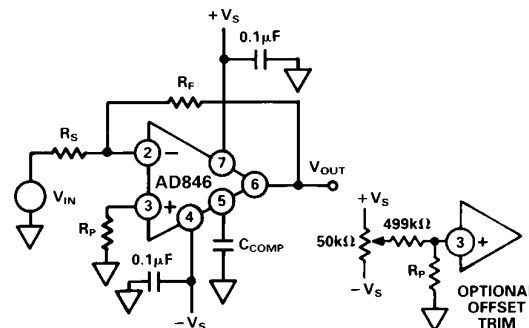

Figure 44. AD846 Inverting Amplifier Showing External Compensation Connection, R_P and Optional V_{OS} Trim

In addition to providing for external compensation, Pin 5 may be used to clamp the output of the amplifier, as shown in Figure 45. The output can be clamped anywhere within the output range (approximately $\pm 10 \text{ V}$) of the amplifier. The input should also be clamped as a precaution against damaging the amplifier's input transistors.

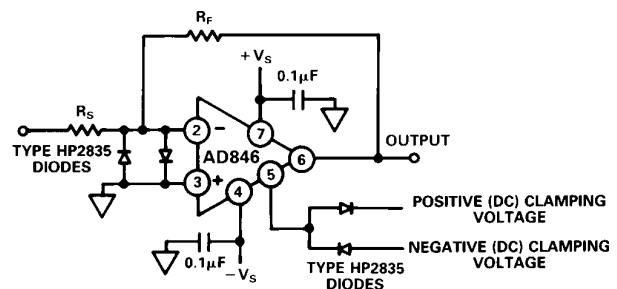

Figure 45. AD846 Used as a Clamped Amplifier

This compensation node may also be used as an additional output terminal as in the precision transconductance amplifier application of Figure 46.

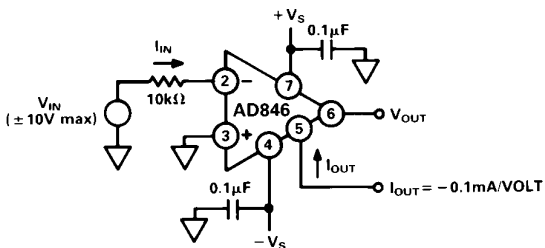

Figure 46. A Precision Transconductance Amplifier

The AD846 can be used in either the inverting transconductance mode as shown in Figure 46, or in a noninverting mode with R_S grounded and V_{IN} applied to the noninverting terminal. The current output is essentially constant over a compliance range of ± 10 V at the compensation node. The output current (from Pin 5) is limited to about ± 1 mA due to internal saturation. Under these circumstances the normal output pin provides a buffered version of the compensation node output voltage. Output load impedance of 500Ω or greater will not affect the accuracy of the transconductance conversion.

THE AD846 IN A 2 MHz, 12-BIT SUBRANGING A/D CONVERTER CIRCUIT

The combination of fast settling times at high gains and low dc errors make the AD846 ideal for use as an error amplifier in high speed, 12-bit subranging A-D applications. In the circuit of Figure 47, an AD842 serves as an input amplifier. First pass conversion is accomplished, in a straightforward manner, determining the top 7 bits. The latch then holds these top 7 bits which are applied to a 7 bit, 12-bit accurate DAC and also to the highest 7 bits of the adder (note that a sample-and-hold should be used ahead of this converter to minimize errors due to its 500 ns acquisition time). In the second pass, the input switches S1 and S2 and S3 are set to state 2. The DAC output is then subtracted from the input signal and the resulting difference is then amplified by an AD846 gain of 32 follower. This gain, together with a 1/64th scale offset, insures a unipolar residue which can be converted by the flash A-D. Conversion is accomplished via switches S1, S2 and S3 in state 1. Switch S1 connects the input signal of the AD846 residue amplifier to ground which minimized overload recovery time.

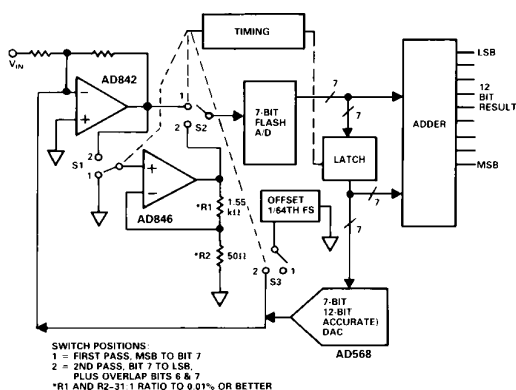

Figure 47. Block Diagram of a 2 MHz, 12-Bit Subranging A/D Converter

THE AD846 AS AN OPEN-LOOP LEVEL SHIFTER

The AD846 can also be used for open-loop level shifting. As shown in Figure 48, resistor R_S is used to develop an input current which is proportional to the input voltage, V_{IN} . This current flows from the compensation node (Pin 5) developing a voltage across resistor R_C (R_C is equal in value to resistor R_S) which, rather than being grounded, has one end tied to reference voltage V_2 . The voltage appearing at Pin 5 is, therefore, voltage V_{IN} plus voltage V_2 and will directly follow changes in V_{IN} . By scaling resistor R_C , a level shift with voltage gain can be produced. In addition, the normal voltage output at Pin 6 is approximately equal to the voltage at Pin 5 thus providing a low impedance, buffered output for the level shifter.

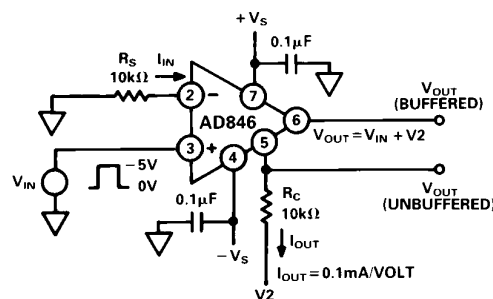

Figure 48. AD846 Connected as a Level Shift Amplifier

THE AD846 AS A HIGH SPEED DAC BUFFER

The AD846 will enable the AD568 12-bit DAC to develop a 10 V output step which settles to within 0.025 percent of its final value in about 100 ns. This AD846/AD568 combination is shown in the circuit of Figure 49. Correct power supply decoupling is essential: a $2.2 \mu\text{F}$ tantalum capacitor connected in parallel with a $0.1 \mu\text{F}$ to $0.01 \mu\text{F}$ ceramic disc capacitor is usually sufficient. These should be placed as close to the power supply pins as possible. Also, a ground plane should be employed; this ensure that there is a low impedance signal path to ground which allows the fastest possible output settling. In 12-bit systems with the AD846 operating at gains of 10 or less, inadequate supply decoupling can cause the output settling to degrade from 100 ns to as much as 300 ns, with a 10 V output step applied.

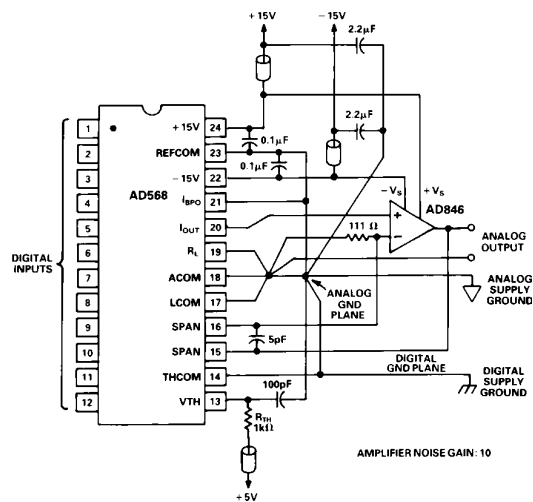
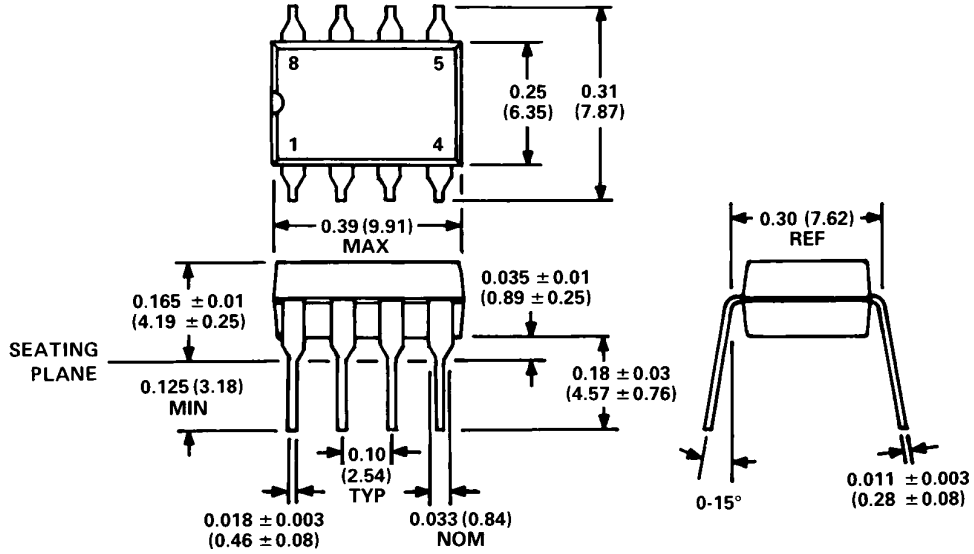

Figure 49. The AD846 Serving as a DAC Buffer

OUTLINE DIMENSIONS
 Dimensions shown in inches and (mm).

**Plastic
 Mini-DIP (N)
 Package**



Cerdip (Q) Package

