

Holemaking

When it comes to innovative tools, Greenlee delivers year after year – with a comprehensive line of holemaking products that is second to none. Use our helpful selection guide to choose the right tool for getting through steel, stainless steel, wood, aluminum, fiberglass, plastic, drywall, ceiling tile, cement board and more. If you need to knockout, drive, drill, cut or punch, you know you'll get through it with Greenlee.

Holemaking

FEATURE PRODUCTS

36



Slug-Buster SC®

69



NEW
DTAPKIT-
Metric Combination
Drill/Tap Bits

74



NEW
Self-Feeding
Spade Bits

81











830Q Quick Change
Hole Saw Kit



SELECTION GUIDES

Holemaking Selection Guide

MATERIAL TYPE	MATERIAL THICKNESS	NUMBER OF HOLES	PRODUCTS	APPLICATION CONSIDERATIONS	PAGES
Steel 	10GA	Highest	Slug-Splitter® Punches	Maximum durability and universal material usage Maximum hole size 2-1/2 inches	34-35
	10GA	High	Slug-Buster® Punches	Maximum hole size 2-1/2 inches	36-42
	10GA	High	Standard Punches	Maximum hole size 5-5/8 inches	43-47
	10GA	Medium-High	Ultra Cutters	Maximum hole size 2-1/2 inches	80
	8GA	High	Carbide-Tipped Hole Cutters	Maximum hole size 2-1/2 inches	79
	10GA	Medium-High	Step Bits	Maximum hole size 1-3/8 inches	70
	10GA	Medium	Hole Saws	Maximum hole size 6 inches	81-85
Stainless Steel 	10GA	Highest	Slug-Splitter Punches	Maximum durability and universal material usage Maximum hole size 2-1/2 inches	34-35
	9GA	Medium-High	Quick Change Carbide-Tipped Cutters	Maximum hole size 3 inches, quick change cutting heads	78
	8GA	Medium-High	Carbide-Tipped Hole Cutters	Maximum hole size 2-1/2 inches	79
Wood 	18"	High	Nail Eater II® Bits	Cuts through nails, good chip removal, max hole size 1-1/4 inches	71
	2-2 x 4's	High	E-Z Bore Bits	Self feed screw for hard or soft woods, max hole size 4-5/8 inches	73
	2 x 4	High	Step Bits	Maximum hole size 1-3/8 inches, low chip removal	70
	16"	Medium	Spade Bits	Maximum hole size 1-1/2 inches	74
	1-5/8" or 2 x 4	High	Hole Saws	Maximum hole size 6 inches	81-85
Aluminum 	10GA	Highest	Slug-Splitter Punches	Maximum durability and universal material usage Maximum hole size 2-1/2 inches	34-35
	10GA	High	Slug-Buster Punches	Maximum hole size 2-1/2 inches	36-42
	10GA	High	Standard Punches	Maximum hole size 5-5/8 inches	43-47
	10GA	High	Ultra Cutters	Maximum hole size 2-1/2 inches	80
	10GA	High	Step Bits	Maximum hole size 1-3/8 inches	70
	10GA	Medium	Hole Saws	Maximum hole size 6 inches	81-85
Fiberglass/Plastic  	approx. 1/8"	Highest	Slug-Splitter Punches	Maximum durability and universal material usage Maximum hole size 2-1/2 inches	34-35
	approx. 1/8"	High	Slug-Buster Punches	Maximum hole size 2-1/2 inches	36-42
	approx. 1/8"	High	Standard Punches	Maximum hole size 5-5/8 inches	43-47
		High	Ultra Cutters	Maximum hole size 2-1/2 inches	80
		Medium-High	Step Bits	Maximum hole size 1-3/8 inches	70
Drywall/Ceiling Tile 	7/8"	High	Recessed Light Hole Saws	Replaceable blades	86
	7/8"	Medium-Low	Quick Cutter	Adjustable or fixed, sprinkler heads or lighting	86
	7/8"	Medium	Keyhole Saw	Non-round holes	90
Quazite®* Enclosures		High	Slug-Buster Punches		36-42
	approx. 1/8"	High	Carbide-Grit Hole Saws		83
Hardyboard Siding		High	Carbide-Grit Hole Saws		83
Cement Board		High	Carbide-Grit Hole Saws		83
Existing Wall			D'versibits	Remodeling, phone, cable, alarm installation	75-76
Non-Round Hole 		High	Non-Round Punches	Square, rectangular, electronic connector holes	61-62
		Medium	Reciprocating Blades		88
		Medium	Jigsaw Blades		89
Non-Conduit Sizes	16-10GA	High	Standard Punches		43-47
Metal Studs	20GA		Stud Punches		67-68

*Quazite is a registered trademark of Strongwell Corporation

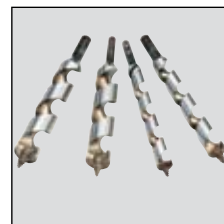
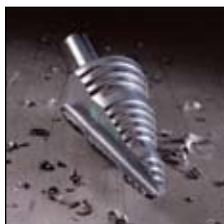

Knockout Punch and Driver Selection Guide

Knockout Punch



PUNCH TYPE	DRIVE METHOD	CAPACITY	SIZE RANGE AVAILABLE	PAGES
Slug-Splitter®	Ratchet, Hydraulic or Battery	Up thru 10 gauge (3.5 mm) stainless steel or mild steel	.598" through 2.526" dia. (15.2 mm through 64 mm)	34-35
Slug-Buster®	Manual, Ratchet, Hydraulic or Battery	Up thru 10 gauge (3.5 mm) mild steel	.492" through 2.52" dia. (12.5 mm through 64.0 mm)	36-42
Standard Round	Manual, Ratchet, Hydraulic or Battery	Up thru 10 gauge (3.5 mm) mild steel and aluminum	1/2" through 5-5/8" dia. (12.7 through 143.7 mm)	43-47

Knockout Punch Driver



DRIVER TYPE	DESCRIPTION	KITS	PAGES
Battery-Powered or Corded Hydraulic Driver	<ul style="list-style-type: none"> Develops 6.7 tons of hydraulic force. Available with a choice of three battery chargers – 115, 230 or 12 volt. Punches up through 10 gauge (3.5 mm) mild steel with Greenlee standard and Slug-Buster knockout punches and 12 gauge (2.5 mm) stainless steel with Greenlee Slug-Splitter knockout punches. 	Available in kits with driver only or with driver and Slug-Buster knockout punches.	48-49
Hand Pump Hydraulic Driver with Ram	<ul style="list-style-type: none"> Powerful hydraulic ram develops 11 tons of hydraulic force. Punches up thru 10 gauge (3.5 mm) mild steel with Greenlee standard and Slug-Buster knockout punches and 10 gauge (3.5 mm) stainless steel with Greenlee Slug-Splitter knockout punches. 	Available in kits with driver only or with driver and either standard, Slug-Buster or Slug-Splitter knockout punches.	56
Foot Pump Hydraulic Driver with Ram	<ul style="list-style-type: none"> Foot operation frees both hands to operate punch. Powerful hydraulic ram develops 11 tons of hydraulic force. Punches up through 10 gauge (3.5 mm) mild steel with Greenlee Standard and Slug-Buster knockout punches and 10 gauge (3.5 mm) stainless steel with Greenlee Slug-Splitter knockout punches. 	Available in kits with driver only or with driver and either standard, Slug-Buster or Slug-Splitter knockout punches.	53
Quick Draw® Flex Hydraulic Driver	<ul style="list-style-type: none"> Allows unlimited driver orientation to simplify access to work area. Develops 8 tons of hydraulic force for easy punching. Punches up through 10 gauge (3.5 mm) mild steel with Greenlee Standard and Slug-Buster knockout punches and 10 gauge (3.5 mm) stainless steel with Greenlee Slug-Splitter knockout punches. 		51
Quick Draw 90° Hydraulic Driver	<ul style="list-style-type: none"> Right angle driver head rotates over 180 degrees for maximum flexibility in tight working areas. Develops 8 tons of hydraulic force for easy punching. Punches up through 10 gauge (3.5 mm) mild steel with Greenlee Standard and Slug-Buster knockout punches and 10 gauge (3.5 mm) stainless steel with Greenlee Slug-Splitter knockout punches. 	Available in kits with driver only or with driver and Slug-Buster knockout punches.	51
Quick Draw® Hydraulic Driver	<ul style="list-style-type: none"> Perfect for fast, straight-on front panel punching. Develops 8 tons of hydraulic force for easy punching. Punches up through 10 gauge (3.5 mm) mild steel with Greenlee Standard and Slug-Buster knockout punches and 10 gauge (3.5 mm) stainless steel with Greenlee Slug-Splitter knockout punches. 	Available in kits with driver only or with driver and Slug-Buster knockout punches.	51
High Leverage Ratchet Driver	<ul style="list-style-type: none"> Time saving ball bearing head punches faster than wrench method. Punches up through 10 gauge (3.5 mm) mild steel with Greenlee Standard Slug-Buster knockout punches and 16 gauge (1.5 mm) stainless steel with Greenlee Slug-Splitter knockout punches. 	Available in kits with driver only or with driver and Slug-Buster knockout punches.	39

SLUG-SPLITTER® KNOCKOUTS

Slug-Splitter SC™ (Self-Centering) Knockout Punches 0.598" to 2.520"



Designed for stainless steel applications

- Slug-Splitter heavy-duty punches are designed to punch up through 10 gauge (3.5 mm) stainless steel.
- Unique slug-splitting design and tool steel construction easily punch 10 gauge (3.5 mm) mild steel and stainless steel.
- Self-centering punch aligns itself on pilot hole. (Slug-Splitter SC)
- No need to draw crosshairs or line up die alignment marks. (Slug-Splitter SC)
- Unique punch profile also splits slugs for easier slug removal.
- Heavy-duty dies and stainless steel draw studs for longer life.
- Excellent abrasion resistance for punching fiberglass and plastic.
- Slug-Splitter punch units consist of: punch, die and draw stud. Check individual punch for specific capacity.
- U.S. Patent No. 4,543,722 for standard Slug-Splitters; Patent Pending for Self-centering Slug-Splitters SC.

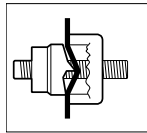

Unique Slug-Splitter punch design creases slug as the punch is drawn into the die.

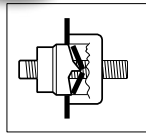

Slug is split in half as punching operation is completed.

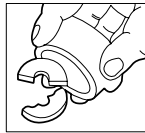

Split slugs fall free from the die and stud.

SPECIFICATIONS

Capacity	Stainless steel up through 10 gauge (3.5 mm)
Application	10-gauge stainless steel, mild steel, fiberglass and plastic enclosures.
Hole Sizes	Conduit Sizes - Hole size is outside diameter of US conduit sizes. Example: 1/2" conduit size actually makes a 7/8" hole. Pg Sizes - European standard pipe sizes. ISO Sizes - International Standards Organization pipe sizes.
Operation	Operate with battery, hydraulic or high leverage ratchet driver only.

SLUG-SPLITTER SC (SELF CENTERING) KNOCKOUT PUNCHES

PUNCH CAT./UPC NO.	DIE CAT./UPC NO.	CONDUIT & PIPE	HOLE SIZE ACTUAL				CAPACITY STAINLESS STEEL		DRAW STUDS			
			Ø (INCH)	Ø (mm)	PG	ISO	GA.	(mm)	7804/7904	7646/7625	1904	
28154	28155	1/2"	7/8	0.885	22.5	16	-	10	3.5	29451	29451	30227
28156	28157	3/4"	-	1.115	28.3	21	-	10	3.5	31872	29452	12099
36490	36489	-	1-7/32	1.210	30.5	-	-	10	3.5	31872	29452	12099
28158	28159	1"	1-11/32	1.352	34.6	-	-	10	3.5	31872	29452	12099
28160	28161	1-1/4"	1-11/16	1.701	43.2	-	-	10	3.5	31872	29452	12099
28162	28163	1-1/2"	1-15/16	1.951	49.6	-	-	10	3.5	-	29452	12099
28165	28166	2"	2-3/8	2.416	61.5	-	-	10	3.5	-	29452	12099

STANDARD SLUG-SPLITTER KNOCKOUT PUNCHES

31117	31126	-	-	0.598	15.2	9	-	12	2.5	29451	29451	30227
04599	04598	-	-	0.638	16.2	-	16	12	2.5	29451	29451	30227
31119	31128	-	-	0.732	18.6	11	-	12	2.5	29451	29451	30227
31120	31129	-	-	0.803	20.4	13	20	12	2.5	29451	29451	30227
04602	04601	-	-	1.000	25.4	-	25	10	3.5	31872	29452	30227
04605	04603	-	-	1.280	32.5	-	32	10	3.5	31872	29452	12099
31122	31135	-	-	1.457	37.0	29	-	10	3.5	31872	29452	12099
04608	04607	-	-	1.595	40.5	-	40	10	3.5	31872	29452	12099
31123	31131	-	-	1.850	47.0	36	-	10	3.5	-	29452	12099
04611	04609	-	-	2.000	50.8	-	50	10	3.5	-	29452	12099
31124	31132	-	-	2.125	54.0	42	-	10	3.5	-	29452	12099
31125	31133	-	-	2.362	60.0	48	-	10	3.5	-	29452	12099
04614	04613	-	-	2.520	64.0	-	63	10	3.5	-	29452	12099

* 16 ga. stainless steel capacity with ratchet driver.

PUNCH UNIT

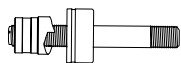

PUNCH UNIT - INCLUDES PUNCH, DIE & DRAW		CONDUIT & PIPE SIZE	HOLE SIZE ACTUAL			CAPACITY STAINLESS STEEL		WEIGHT		DRIVER				DRAW STUD
CAT. NO.	UPC NO.		Ø INCH	Ø mm	GA	mm	LBS.	kg	1904	7804/7904	LS60*/CLC60	7646/7625		
745R-1/2	30384	1/2"	7/8	.885	22.5	16	1.5	.6	.27	x				30227
745H-1/2	29560	1/2"	7/8	.885	22.5	10	3.5	.7	.32		x	x	x	29451
740H-1-7/32 Oil Tight	29563	—	1-7/32	1.210	30.5	10	3.5	1.2	.54		x	x	x	29452

* Battery-Powered or Corded Knockout Punch Driver

R = REPLACEMENT PART **A** = ACCESSORY

SLUG-SPLITTER SC™ KNOCKOUT KITS

Slug-Splitter SC Ram and Hand Pump Hydraulic Driver Punch Kits

Designed for stainless steel applications



7506 Punch Kit



7307 Punch Kit (driver not included)



744 Punch Kit (driver not included)

All Kits Feature:

- Slug-Splitter SC (Self Centering) knockout punches with capacities up through 10 gauge (3.5 mm) stainless steel. Refer to individual punch capacity ratings.
- Self-centering punch aligns itself on pilot hole. (Slug-Splitter SC)
- No need to draw crosshairs or line up die alignment marks. (Slug-Splitter SC)

7506 Kit Features

- Fast, easy and simple to operate.
- Compact design makes this a perfect choice for use on construction sites and maintenance jobs.
- Will also drive 751 Cable Cutter head.
- Powerful 11-ton hydraulic ram.
- 3-foot hose.

CAT. NO.	UPC NO.	DESCRIPTION	WEIGHT	
			LBS.	kg.
744	29619	1/2" through 1-1/4" Conduit Size Slug-Splitter SC Knockout Punch Kit	5	2.3
7307	29528	1/2" through 2" Conduit Size Slug-Splitter SC Knockout Punch Kit	10.4	4.7
7506	30385	1/2" through 2" Conduit Size Slug-Splitter SC Knockout Punch Kit with Hydraulic Ram and Hand Pump	32	14.5

SPECIFICATIONS

Operation	Description
7307/29528	Quick Draw, Quick Draw 90 and Quick Draw Flex Hydraulic Drivers, Battery-Powered Drivers, 7646 and 7625 Ram-Type Drivers.
744/29619	Quick Draw, Quick Draw 90 and Quick Draw Flex Hydraulic Drivers, Battery-Powered Drivers, 7646 and 7625 Ram-Type Drivers.
7506/30385	Hydraulic Ram and Hand Pump included.

NOTE: See Slug-Splitter® knockout punch units on page 34 for list of individual punches, dies and draw studs.

CAT. NO.	UPC NO.	DESCRIPTION	CONDUIT & PIPE SIZE	HOLE SIZE		CAPACITY		KIT CAT./UPC NO.			
				ACTUAL		STAINLESS STEEL		744/	7307/	7506/	
				Ø INCH	Ø mm	GA	mm	29619	29528	30385	
28154	28154	1/2" Conduit Size Punch	1/2"	7/8	.885	22.5	10	3.5	✓	✓	✓
28155	28155	1/2" Conduit Size Die	1/2"	7/8	.885	22.5	10	3.5	✓	✓	✓
28156	28156	3/4" Conduit Size Punch	3/4"	—	1.115	28.3	10	3.5	✓	✓	✓
28157	28157	3/4" Conduit Size Die	3/4"	—	1.115	28.3	10	3.5	✓	✓	✓
36490	36490	1-7/32" Punch Oiltight	—	1-7/32	1.210	30.5	10	3.5		✓	
36489	36489	1-7/32" Die Oiltight	—	1-7/32	1.210	30.5	10	3.5		✓	
28158	28158	1" Conduit Size Punch	1"	1-11/32	1.362	34.6	10	3.5	✓	✓	✓
28159	28159	1" Conduit Size Die	1"	1-11/32	1.362	34.6	10	3.5	✓	✓	✓
28160	28160	1-1/4" Conduit Size Punch	1-1/4"	1-11/16	1.701	43.2	10	3.5	✓	✓	✓
28161	28161	1-1/4" Conduit Size Die	1-1/4"	1-11/16	1.701	43.2	10	3.5	✓	✓	✓
28162	28162	1-1/2" Conduit Size Punch	1-1/2"	1-15/16	1.951	49.6	10	3.5		✓	✓
28163	28163	1-1/2" Conduit Size Die	1-1/2"	1-15/16	1.951	49.6	10	3.5		✓	✓
28165	28165	2" Conduit Size Punch	2"	2-3/8	2.416	61.5	10	3.5		✓	✓
28166	28166	2" Conduit Size Die	2"	2-3/8	2.416	61.5	10	3.5		✓	✓
29451	29451	7/16" x 4-1/4" Draw Stud							✓	✓	✓
29452	29452	3/4" x 5-1/2" Draw Stud								✓	✓
29529	29529	Metal Case								✓	
19193	19193	Metal Case							✓		
31068	31068	Metal Case									✓
746SS	30387	Ram (includes 1 each of the following 3 items)									✓
29452	29452	3/4" x 5-1/2" Draw Stud									✓
54167	54167	1/4" Female Coupler									✓
54168	54168	Dust Plug									✓
15908	15908	Spacer Group (includes 1 each of the following 3 items)									✓
1924AA	03248	Spacer-Short									✓
1925AA	03249	Spacer-Medium									✓
1926AA	06904	Spacer-Long									✓
767	13284	Hydraulic Hand Pump									✓
38316	38316	High Pressure Hose Unit—1/4" x 3' (includes 1 each of the following 3 items)									✓
54169	54169	1/4" Male Coupler									✓
54170	54170	Dust Cap									✓
06302	06302	High Pressure Hose—1/4" x 3'									✓

R = REPLACEMENT PART **A** = ACCESSORY

SLUG-BUSTER® KNOCKOUTS

Slug-Buster SC® (Self-Centering)



- Save time and ensure accuracy! Self-centering punch aligns itself on pilot hole.
- No need to draw crosshairs or line up die alignment marks.
- Unique punch also splits slugs for easier slug removal.
- US Patent No. 6,973,729



PUNCH UNIT		CONDUIT & PIPE SIZE	HOLE SIZES		WEIGHT OF PUNCH UNIT		PUNCH ONLY		DIE ONLY		STUD ONLY	
CAT NO.	UPC		INCH	MM	LBS.	G	CAT NO.	UPC	CAT NO.	UPC	CAT NO.	UPC
77U-1/2*	10801	1/2"	.885	22.2	0.3	137	77P-1/2	11361	14722	14722	00042	00042
							77P-1/2P*	11261	14722P*	01992	00042	00042
77U-3/4*	10802	3/4"	1.115	28.3	0.8	363	77P-3/4	11362	124AV	06972	294AVBB	04040
							77-3/4P*	11262	124AVP*	01993	294AVBBP*	01987
10807*	10807	-	1.21	30.5	0.9	408	11357	11357	3627B	3627B	294AVBB	04040
77U-1*	10803	1"	1.362	34.6	1	454	77P-1	11363	126AV	04011	394AVBB	04040
							77P-1P*	11263	126AVP*	01994	294AVBBP	01987
77U-1-1/4*	10804	1-1/4"	1.701	43.2	1.3	590	77P-1-1/4	11364	128AV	04013	294AVBB	04040
							77P-1-1/4P*	11264	128AVP*	01995	294AVBBP*	01987
77U-1-1/2*	10805	1-1/2"	1.951	49.6	2.1	953	77P-1-1/2	11365	440AV	04061	304AVBB	04042
							77P-1-1/2P*	11265	440AVP*	01996	304AVBBP*	01988
77U-2*	10806	2"	2.416	61.4	2.3	1043	77P-2	11366	442AV	04063	304AVBB	04042
							77P-2P*	11266	442AVP*	01997	304AVBBP*	01988
10800	10800	1/2"-2" Kit	-	-	-	-	-	-	-	-	-	-

*POP Packaged

10800 Slug-Buster SC Knockout Kit Includes

CAT NO.	UPC NO.	DESCRIPTION	CONDUIT SIZE	HOLE SIZES
77P-1/2	11361	1/2" Punch Buster, SC	1/2"	.885
14722	14722	1/2" Die Rd.	1/2"	.885
77P-3/4	11362	3/4" Punch Buster, SC	3/4"	1.115
124AV	06972	3/4" Die Rd.	3/4"	1.115
77P-1	11363	1" Punch Buster, SC	1"	1.362
126AV	04011	1" Die Rd.	1"	1.362
77P-1-1/4	11364	1-1/4" Punch Buster, SC	1-1/4"	1.701
128AV	04013	1-1/4" Die Rd.	1-1/4"	1.701
77P-1-1/2	11365	1-1/2" Punch Buster, SC	1-1/2"	1.951
440AV	04061	1-1/2" Die Rd.	1-1/2"	1.951
77P-2	11366	2" Punch Buster, SC	2"	2.416
442AV	04063	2" Die Rd.	2"	2.416

Slug-Buster® Knockout Punches 0.492" to 2.520"



- The contractor's choice – worldwide.
- Unique punch profile also splits slugs for easier slug removal.
- Use with battery-powered, hydraulic, ratchet or manual drivers.
- Uses standard Greenlee dies and draw studs.
- Slug Buster punches available in sizes up thru 2.52" (64.0 mm).
- U.S. Patent #4,543,722 for Slug-Buster.

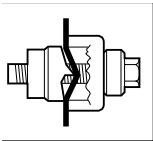

Unique Slug-Buster punch design creases slug as the punch is drawn into the die.

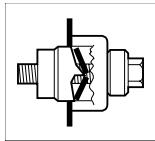

Slug is split in half as punching operation is completed.

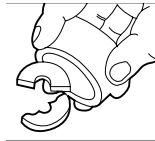

Split slugs fall free from the die and stud.

SPECIFICATIONS

Capacity	Mild steel up through 10 gauge (3.5 mm).
Application	Punch mild steel, aluminum, fiberglass and plastic.
Hole Sizes	Conduit Sizes- Hole size is outside diameter of US conduit sizes. i.e 1/2" conduit actually 7/8". Pg Sizes- European standard pipe sizes. ISO Sizes- International Standards Organization pipe sizes.
Operation	Battery, hydraulic, ratchet or manual drivers. When used with ratchet, hydraulic or battery drivers, buy the punch and die only; the draw stud is part of the driver kit.

PUNCH UNIT

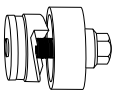

REPLACEMENT PARTS

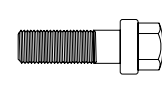
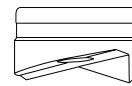

PUNCH UNIT INCLUDES PUNCH, DIE AND DRAW STUD		CONDUIT & PIPE SIZE	HOLE SIZE ACTUAL			CAPACITY MILD STEEL		WEIGHT		REPLACEMENT PUNCH		REPLACEMENT DIE		REPLACEMENT MANUAL DRAW STUD			
CAT. NO.	UPC NO.		Ø INCH	Ø mm	PG	ISO	GA.	mm	LBS.	g	CAT. NO.	UPC NO.	CAT. NO.	UPC NO.	CAT. NO.	UPC NO.	
06727	06727	—	—	0.492	12.5	7	12	16	1.5	0.3	137	06728	06728	06729	06729	1675AV	04218
7211EBB-15.2	31989	—	—	0.598	15.2	9	—	14	2.0	0.3	137	31969	31969	32002	32002	00042	00042
35177	35177	—	—	0.638	16.2	—	16	14	2.0	0.3	137	35163	35163	35162	35162	00042	00042
7211EBB-18.6	31990	—	—	0.732	18.6	11	—	14	2.0	0.3	137	31970	31970	32003	32003	00042	00042
7211EBB-20.4	31991	—	—	0.803	20.4	13	20	14	2.0	0.3	137	31971	31971	32004	32004	00042	00042
7211BB-1/2	31962	1/2"	7/8	0.885	22.5	16	—	10	3.5	0.3	137	721-1/2	31756	14722	14722	00042	00042
◇	◇	1/2"	7/8	0.885	22.5	16	—	10	3.5	—	—	721-1/2P◇	01980	14722P◇	01992	00042P	06678
35178	35178	—	1	1.000	25.4	—	25	14	2.0	0.5	227	35165	35165	35164	35164	00042P	00042P
7211BB-3/4	31963	3/4"	—	1.115	28.3	—	—	10	3.5	0.8	363	721-3/4	31757	124AV	06972	249AVBB	04040
◇	◇	3/4"	—	1.115	28.3	—	—	10	3.5	—	—	721-3/4P◇	01981	124AVP◇	01993	249AVBBP◇	01987
7211EBB-28.3	31993	—	—	1.115	28.3	21	—	14	2.0	0.5	227	31973	31973	32006	32006	00042	00042
60246	60246	—	1-7/32	1.210	30.5	—	—	10	3.5	0.6	273	60237	60237	36278	36278	249AVBB	04040
36508	36508	—	1-7/32	1.210	30.5	—	—	14	2.0	0.6	273	36284	36284	36279	36279	00042	00042
35179	35179	—	—	1.280	32.5	—	32	10	3.5	0.8	363	35169	35169	35168	35168	249AVBB	04040
7211BB-1	31964	1"	—	1.362	34.6	—	—	10	3.5	1	454	721-1	31758	126AV	04011	249AVBB	04040
◇	◇	1"	—	1.362	34.6	10	—	10	3.5	—	—	721-1P◇	01982	126AVP◇	01994	249AVBBP◇	01987
7211EBB-37	31995	—	—	1.457	37.0	29	—	10	3.5	1.2	545	31975	31975	32008	32008	249AVBB	04040
35180	35180	—	—	1.595	40.5	—	40	10	3.5	1.2	545	35158	35158	35159	35159	249AVBB	04040
7211BB-1-1/4	31965	1-1/4"	—	1.701	43.2	—	—	10	3.5	1.3	590	721-1-1/4	31759	128AV	04013	249AVBB	04040
◇	◇	1-1/4"	—	1.701	43.2	—	—	10	3.5	—	—	721-1-1/4P◇	01983	128AVP◇	01995	249AVBBP◇	01987
7211EBB-47	31996	—	—	1.850	47.0	36	—	10	3.5	1.9	862	31976	31976	32009	32009	304AVBB	04042
7211BB-1-1/2	31966	1-1/2"	—	1.951	49.6	—	—	10	3.5	2.1	953	721-1-1/2	31760	440AV	04061	304AVBB	04042
◇	◇	1-1/2"	—	1.951	49.6	—	—	10	3.5	—	—	721-1-1/2P◇	01984	440AVP◇	01996	304AVBBP◇	01988
35181	35181	—	2	2.000	50.8	—	50	10	3.5	2.3	1043	35160	35160	35161	35161	304AVBB	04042
36171	36171	—	2-1/8	2.125	54.0	42	—	10	3.5	2.5	1134	36172	36172	36173	36173	304AVBB	04042
7211EBB-60	31998	—	—	2.362	60.0	48	—	10	3.5	2.8	1270	31978	31978	32011	32011	304AVBB	04042
7211BB-2	31967	2"	2-3/8	2.416	61.5	—	—	10	3.5	3.2	1452	721-2	31761	442AV	04063	304AVBB	04042
◇	◇	2"	2-3/8	2.416	61.5	—	—	10	3.5	—	—	721-2P◇	01985	442AVP◇	01997	304AVBBP◇	01988
35182	35182	—	—	2.520	64.0	—	63	10	3.5	3.4	1542	35167	35167	35166	35166	304AVBB	04042

◇ Individually Packaged in Point of Purchase clamshell for display opportunities

SLUG-BUSTER® KNOCKOUT KITS

Slug-Buster Manual Knockout Kits



7235BB

- Assortment of commonly used Slug-Buster knockout punches, packaged to meet the contractor's needs.
- High-impact, rugged plastic carrying case.



7237BB

CAT. NO.	UPC NO.	DESCRIPTION	CAPACITY		
			MILD STEEL GA	WEIGHT mm	LBS. kg.
7235BB	32013	1/2" - 1-1/4" Conduit Size Manual Slug-Buster Knockout Punch Kit	10	3.5	2.7 1.2
7237BB	32014	1-1/2" and 2" Conduit Size Manual Slug-Buster Knockout Punch Kit	10	3.5	5.2 2.4

7235BB/32013 SLUG-BUSTER KNOCKOUT PUNCH KIT INCLUDES

CAT. NO.	UPC NO.	DESCRIPTION	HOLE SIZE ACTUAL		
			Ø INCH	Ø mm	PG
721-1/2	31756	1/2" Conduit Size Punch	7/8	.885	22.5 16
14722	14722	1/2" Conduit Size Die	7/8	.885	22.5 16
00042	00042	Draw Stud-3/8" x 1-5/8"			
721-3/4	31757	3/4" Conduit Size Punch	—	1.115	28.3 —
124AV	06972	3/4" Conduit Size Die	—	1.115	28.3 —
721-1	31758	1" Conduit Size Punch	—	1.362	34.6 —
126AV	04011	1" Conduit Size Die	—	1.362	34.6 —
721-1-1/4	31759	1-1/4" Conduit Size Punch	—	1.701	43.2 —
128AV	04013	1-1/4" Conduit Size Die	—	1.701	43.2 —
249AVBB	04040	Draw Stud-3/4" x 2-1/8"			
31880	31880	Plastic Case			

7237BB/32014 SLUG-BUSTER KNOCKOUT PUNCH KIT INCLUDES

CAT. NO.	UPC NO.	DESCRIPTION	HOLE SIZE ACTUAL		
			Ø INCH	Ø mm	PG
721-1-1/2	31760	1-1/2" Conduit Size Punch	—	1.951	49.6 —
440AV	04061	1-1/2" Conduit Size Die	—	1.951	49.6 —
721-2	31761	2" Conduit Size Punch	2-3/8	2.416	61.5 —
442AV	04063	2" Conduit Size Die	2-3/8	2.416	61.5 —
304AVBB	04042	Draw Stud-3/4" x 2-15/16"			
32012	32012	Plastic Case			

Slug-Buster Ratchet Punch Driver Kits



1906SB

- Time-saving ball bearing head punches faster than wrench method.
- Requires less than half the force of conventional ratchet drivers.
- Punches up through 10 gauge (3.5 mm) mild steel with Greenlee Standard and Slug-Buster punches; and 16 gauge (1.5 mm) stainless steel with Greenlee Slug-Splitter® punches.
- Ratchet action allows for use in confined areas.
- Unique design eliminates stud rotation during punching – lowers the strain on studs.
- Steel carrying case.

CAT. NO.	UPC NO.	DESCRIPTION	WEIGHT	
			LBS.	kg.
1904	30216	Basic High Leverage Ratchet Driver with Three Draw Studs and Case	14	6.4
1906SB	34357	High Leverage Ratchet Driver with 1/2" through 2" Slug-Buster Conduit Size Punches, Dies, Draw Studs and Case	20	9.1

CAT. NO.	UPC NO.	DESCRIPTION	HOLE SIZE						KIT CAT./UPC NO.	
			CONDUIT & PIPE SIZE	ACTUAL		CAPACITY MILD STEEL		1904/30216	1906SB/34357	
				Ø INCH	Ø mm	GA	mm			
721-1/2	31756	1/2" Conduit Size Slug-Buster® Punch	1/2"	7/8	0.885	22.5	10	3.5		✓
14722	14722	1/2" Conduit Size Die	1/2"	7/8	0.885	22.5	10	3.5		✓
721-3/4	31757	3/4" Conduit Size Slug-Buster Punch	3/4"	—	1.115	28.3	10	3.5		✓
124AV	06972	3/4" Conduit Size Die	3/4"	—	1.115	28.3	10	3.5		✓
721-1	31758	1" Conduit Size Slug-Buster Punch	1"	—	1.362	34.6	10	3.5		✓
126AV	04011	1" Conduit Size Die	1"	—	1.362	34.6	10	3.5		✓
721-1-1/4	31759	1-1/4" Conduit Size Slug-Buster Punch	1-1/4"	1-11/16	1.701	43.2	10	3.5		✓
128AV	04013	1-1/4" Conduit Size Die	1-1/4"	1-11/16	1.701	43.2	10	3.5		✓
721-1-1/2	31760	1-1/2" Conduit Size Slug-Buster Punch	1-1/2"	1-15/16	1.951	49.6	10 *	3.5		✓
440AV	04061	1-1/2" Conduit Size Die	1-1/2"	1-15/16	1.951	49.6	10 *	3.5		✓
721-2	31761	2" Conduit Size Slug-Buster Punch	2"	2-3/8	2.416	61.5	10 *	3.5		✓
442AV	04063	2" Conduit Size Die	2"	2-3/8	2.416	61.5	10 *	3.5		✓
12097	12097	Draw Stud – 3/8" x 2-15/16"							✓	✓
12099	12099	Draw Stud – 3/4" x 4-3/4"							✓	✓
30227	30227	Draw Stud – 7/16" x 3-5/8"							✓	
30228	30228	Steel Case							✓	✓
20495	20495	Ratchet wrench only							✓	✓
30225	30225	Handle							✓	✓

Draw Studs and Misc.

Punches and Dies

R = REPLACEMENT PART A = ACCESSORY

Holemaking

USA Tel: 800.435.0786
Fax: 800.451.2632

Canada Tel: 800.435.0786
Fax: 800.524.2853

International Tel: +1.815.397.7070
Fax: +1.815.397.9247

Slug-Buster® Knockout Kit with Ratchet Wrench



- 1" Hex Ratchet Wrench allows use with both 3/8" (9.5 mm) and 3/4" (19.1 mm) draw studs.
- High-impact, rugged plastic carrying case.

CAT. NO.	UPC NO.	DESCRIPTION	CAPACITY			
			MILD STEEL		WEIGHT	
			GA	mm	LBS.	kg.
7238SB	34757	1/2" – 2" Conduit Size Slug-Buster Knockout Punch Kit	10	3.5	10	4.54

7238SB/34757 SLUG-BUSTER® KNOCKOUT PUNCH KIT INCLUDES

CAT. NO.	UPC NO.	DESCRIPTION	HOLE SIZE ACTUAL			
			Ø INCH	Ø mm	PG	
34941	34941 R	Ratchet wrench – 1" Hex				
721-1/2	31756 R	1/2" Conduit Size Punch	7/8	.885	22.5	16
14722	14722 R	1/2" Conduit Size Die	7/8	.885	22.5	16
721-3/4	31757 R	3/4" Conduit Size Punch	—	1.115	28.3	—
124AV	06972 R	3/4" Conduit Size Die	—	1.115	28.3	—
721-1	31758 R	1" Conduit Size Punch	—	1.362	34.6	—
126AV	04011 R	1" Conduit Size Die	—	1.362	34.6	—
721-1-1/4	31759 R	1-1/4" Conduit Size Punch	—	1.701	43.2	—
128AV	04013 R	1-1/4" Conduit Size Die	—	1.701	43.2	—
721-1-1/2	31760 R	1-1/2" Conduit Size Punch	—	1.951	49.6	—
440AV	04061 R	1-1/2" Conduit Size Die	—	1.951	49.6	—
721-2	31761 R	2" Conduit Size Punch	2-3/8	2.416	61.5	—
442AV	04063 R	2" Conduit Size Die	2-3/8	2.416	61.5	—
00042	00042 R	Ball Bearing Draw Stud with 1" Hex Head–3/8" x 1-5/8"				
304AVBB	04042 R	Ball Bearing Draw Stud–3/4" x 2-15/16"				
34758	34758 R	Plastic Case				

International Tel: +1.815.397.7070
Fax: +1.815.397.9247

Canada Tel: 800.435.0786
Fax: 800.524.2853

USA Tel: 800.435.0786
Fax: 800.451.2632

Slug-Buster® Knockout Kit with Ratchet Wrench - Metric



- 1" (25.4 mm) hex ratchet wrench allows use with both 3/8" (9.5 mm) and 3/4" (19.1 mm) draw studs.
- 3/8" (9.7 mm) Kwik Stepper® step bit included.
- High-impact, rugged plastic carrying case.

CAT. NO.	UPC NO.	DESCRIPTION	WEIGHT	
			LBS.	kg.
36690	36690	Pg-9 through 30.5 mm Manual Slug-Buster Metric Knockout Punch Kit	4.7	2.1
36691	36691	Pg-9 through Pg-48 and 30.5 mm Manual Slug-Buster Metric Knockout Punch Kit	9	4.1
36692	36692	ISO-16 through ISO-40 Manual Slug-Buster Metric Knockout Punch Kit	5.6	2.5
36693	36693	ISO-16 through ISO-63 Manual Slug-Buster Metric Knockout Punch Kit	9	4.1

CAT. NO.	UPC NO.	DESCRIPTION	HOLE SIZE				CAPACITY MILD STEEL		KIT CAT./UPC NO.				
			ACTUAL		PG	ISO	GA	mm	36690	36691	36692	36693	
			Ø INCH	Ø mm									
31969	31969	Slug-Buster Punch	—	0.598	15.2	9	—	14	2.0	✓	✓		
32002	32002	Die	—	0.598	15.2	9	—	14	2.0	✓	✓		
31970	31970	Slug-Buster Punch	—	0.732	18.6	11	—	14	2.0	✓	✓		
32003	32003	Die	—	0.732	18.6	11	—	14	2.0	✓	✓		
31971	31971	Slug-Buster Punch	—	0.803	20.4	13	20	14	2.0	✓	✓	✓	✓
32004	32004	Die	—	0.803	20.4	13	20	14	2.0	✓	✓	✓	✓
721-1/2	31756	Slug-Buster Punch	7/8	0.885	22.5	16	—	10	3.5	✓	✓		
14722	14722	Die	7/8	0.885	22.5	16	—	10	3.5	✓	✓		
31973	31973	Slug-Buster Punch	—	1.115	28.3	21	—	14	2.0	✓	✓		
32006	32006	Die	—	1.115	28.3	21	—	14	2.0	✓	✓		
36284	36284	30.5 mm Slug-Buster Punch	1-7/32	1.210	30.5	—	—	14	2.0	✓	✓		
36279	36279	30.5 mm Die	1-7/32	1.210	30.5	—	—	14	2.0	✓	✓		
31975	31975	Slug-Buster Punch	—	1.457	37.0	29	—	10	3.5		✓		
32008	32008	Die	—	1.457	37.0	29	—	10	3.5		✓		
31976	31976	Slug-Buster Punch	—	1.850	47.0	36	—	10	3.5		✓		
32009	32009	Die	—	1.850	47.0	36	—	10	3.5		✓		
31978	31978	Slug-Buster Punch	—	2.362	60.0	48	—	10	3.5		✓		
32011	32011	Die	—	2.362	60.0	48	—	10	3.5		✓		
35163	35163	ISO-16 Slug-Buster Punch	—	0.638	16.2	—	16	14	2.0			✓	✓
35162	35162	ISO-16 Die	—	0.638	16.2	—	16	14	2.0			✓	✓
35165	35165	ISO-25 Slug-Buster Punch	1	1.000	25.4	—	25	14	2.0			✓	✓
35164	35164	ISO-25 Die	1	1.000	25.4	—	25	14	2.0			✓	✓
35169	35169	ISO-32 Slug-Buster Punch	—	1.280	32.5	—	32	10	3.5			✓	✓
35168	35168	ISO-32 Die	—	1.280	32.5	—	32	10	3.5			✓	✓
35158	35158	ISO-40 Slug-Buster Punch	—	1.595	40.5	—	40	10	3.5			✓	✓
35159	35159	ISO-40 Die	—	1.595	40.5	—	40	10	3.5			✓	✓
35160	35160	ISO-50 Slug-Buster Punch	2	2.000	50.8	—	50	10	3.5				✓
35161	35161	ISO-50 Die	2	2.000	50.8	—	50	10	3.5				✓
35167	35167	ISO-63 Slug-Buster Punch	2-1/2	2.500	63.5	—	63	10	3.5				✓
35166	35166	ISO-63 Die	2-1/2	2.500	63.5	—	63	10	3.5				✓
249AVBB	04040	Draw Stud – 3/4" x 2-1/8"										✓	
304AVBB	04042	Draw Stud – 3/4" x 2-15/16"									✓		✓
36018	36018	Kwik Stepper® Step Bit 9.7 mm								✓	✓	✓	✓
34941	34941	Ratchet Wrench – 1" Hex								✓	✓	✓	✓
00042	00042	Ball Bearing Drive Nut with 1" Hex Head, 3/8" x 3"								✓	✓	✓	✓
36685	36685	Plastic Case								✓	✓	✓	✓

Punches and Dies

Draw Studs and Misc.

R = REPLACEMENT PART A = ACCESSORY

Slug-Buster® Knockout Punch Kits for Ratchet/Hydraulic Drivers

Holemaking



- Packaged in carton for easy insertion into your existing case.
- Replacement punch kits for battery-powered, hydraulic and ratchet drivers.

CAT. NO.	UPC NO.	DESCRIPTION	WEIGHT	
			LBS.	kg.
7216	32017	1/2" - 2" Conduit Size Knockout Punch and Die Kit	5.5	2.5
7214E	32398	Pg-9 through 30.5 mm Slug-Buster Pg Punch Kit	1.3	.6
7215E	32803	Pg-9 through Pg-48 and 30.5 mm Slug-Buster Pg Punch Kit	5.1	2.3
35617	35617	ISO-16 through ISO-40 Slug-Buster ISO Punch Kit	1.6	.7
06892	06892	ISO-16 through ISO-63 Slug-Buster ISO Punch Kit	5.5	2.5

CAT. NO.	UPC NO.	DESCRIPTION	CONDUIT & PIPE SIZE		HOLE SIZE				CAPACITY- MILD STEEL		KIT CAT./UPC NO.				
					ACTUAL		PG	ISO	GA	mm	7216/32017	7214E/32398	7215E/32803	35617	06892
					Ø INCH	Ø mm									
721-1/2	31756	1/2" Conduit Size Punch	1/2"	7/8	.885	22.5	16	—	10	3.5	✓	✓	✓		
14722	14722	1/2" Conduit Size Die	1/2"	7/8	.885	22.5	16	—	10	3.5	✓	✓	✓		
721-3/4	31757	3/4" Conduit Size Punch	3/4"	—	1.115	28.3	—	—	10	3.5	✓				
124AV	06972	3/4" Conduit Size Die	3/4"	—	1.115	28.3	—	—	10	3.5	✓				
721-1	31758	1" Conduit Size Punch	1"	—	1.362	34.6	—	—	10	3.5	✓				
126AV	04011	1" Conduit Size Die	1"	—	1.362	34.6	—	—	10	3.5	✓				
721-1-1/4	31759	1-1/4" Conduit Size Punch	1-1/4"	—	1.701	43.2	—	—	10	3.5	✓				
128AV	04013	1-1/4" Conduit Size Die	1-1/4"	—	1.701	43.2	—	—	10	3.5	✓				
721-1-1/2	31760	1-1/2" Conduit Size Punch	1-1/2"	—	1.951	49.6	—	—	10	3.5	✓				
440AV	04061	1-1/2" Conduit Size Die	1-1/2"	—	1.951	49.6	—	—	10	3.5	✓				
721-2	31761	2" Conduit Size Punch	2"	2-3/8	2.416	61.5	—	—	10	3.5	✓				
442AV	04063	2" Conduit Size Die	2"	2-3/8	2.416	61.5	—	—	10	3.5	✓				
31969	31969	Punch	—	—	.598	15.2	9	—	14	2.0		✓	✓		
32002	32002	Die	—	—	.598	15.2	9	—	14	2.0		✓	✓		
31970	31970	Punch	—	—	.732	18.6	11	—	14	2.0		✓	✓		
32003	32003	Die	—	—	.732	18.6	11	—	14	2.0		✓	✓		
31971	31971	Punch	—	—	.803	20.4	13	20	14	2.0		✓	✓	✓	✓
32004	32004	Die	—	—	.803	20.4	13	20	14	2.0		✓	✓	✓	✓
31973	31973	Punch	—	—	1.115	28.3	21	—	14	2.0		✓	✓		
32006	32006	Die	—	—	1.115	28.3	21	—	14	2.0		✓	✓		
36284	36284	30.5 mm Punch	—	1-7/32	1.210	30.5	—	—	14	3.5		✓	✓		
36279	36279	30.5 mm Die	—	1-7/32	1.210	30.5	—	—	14	3.5		✓	✓		
31975	31975	Punch	—	—	1.457	37.0	29	—	10	3.5			✓		
32008	32008	Die	—	—	1.457	37.0	29	—	10	3.5			✓		
31976	31976	Punch	—	—	1.850	47.0	36	—	10	3.5			✓		
32009	32009	Die	—	—	1.850	47.0	36	—	10	3.5			✓		
31978	31978	Punch	—	—	2.362	60.0	48	—	10	3.5			✓		
32011	32011	Die	—	—	2.362	60.0	48	—	10	3.5			✓		
35163	35163	ISO-16 Punch	—	—	0.638	16.2	—	16	14	2.0				✓	✓
35162	35162	ISO-16 Die	—	—	0.638	16.2	—	16	14	2.0				✓	✓
35165	35165	ISO-25 Punch	—	1	1.000	25.4	—	25	14	2.0				✓	✓
35164	35164	ISO-25 Die	—	1	1.000	25.4	—	25	14	2.0				✓	✓
35169	35169	ISO-32 Punch	—	—	1.280	32.5	—	32	10	3.5				✓	✓
35168	35168	ISO-32 Die	—	—	1.280	32.5	—	32	10	3.5				✓	✓
35158	35158	ISO-40 Punch	—	—	1.595	40.5	—	40	10	3.5				✓	✓
35159	35159	ISO-40 Die	—	—	1.595	40.5	—	40	10	3.5				✓	✓
35160	35160	ISO-50 Punch	—	2	2.000	50.8	—	50	10	3.5					✓
35161	35161	ISO-50 Die	—	2	2.000	50.8	—	50	10	3.5					✓
35167	35167	ISO-63 Punch	—	—	2.520	64.0	—	63	10	3.5					✓
35166	35166	ISO-63 Die	—	—	2.520	64.0	—	63	10	3.5					✓

 International Tel: +1.815.397.7070
 Fax: +1.815.397.9247

 USA Tel: 800.435.0786
 Canada Tel: 800.435.0786
 Fax: 800.451.2632

STANDARD KNOCKOUT PUNCHES

Standard Round Knockout Punches 0.5" to 5.675"

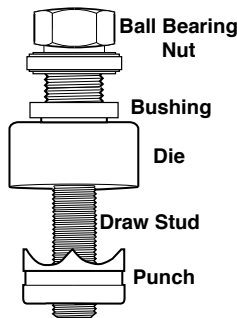

- Round standard metal punch units are complete units consisting of punch, die and draw stud.
- Use with battery-powered, hydraulic, ratchet or manual drivers.
- Properly assembled through pilot holes, they will make clean, fast and accurate holes.

SPECIFICATIONS

Capacity	Mild steel up through 10 gauge (3.5 mm).
Application	Punch mild steel, aluminum, fiberglass and plastic.
Hole Sizes	Conduit Sizes - Hole size is outside diameter of US conduit sizes. Example: 1/2" conduit size punch actually makes a 7/8" hole. Pg Sizes - European standard pipe sizes. ISO Sizes - International Standards Organization pipe sizes.
Operation	Operate with battery-powered, hydraulic, ratchet or manual drivers. When used with battery-powered, hydraulic, or ratchet drivers buy the punch and die only; the draw stud is part of the driver kit.

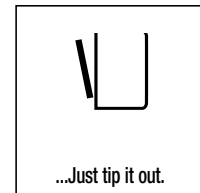
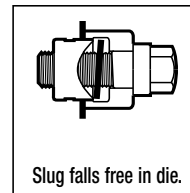
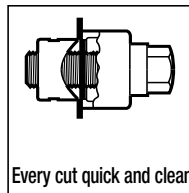

Standard Round Knockout Punches

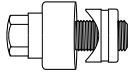
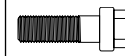
PUNCH UNIT

REPLACEMENT PARTS

PUNCH KIT-INCLUDES		HOLE SIZE						CAPACITY			REPLACEMENT PUNCH		REPLACEMENT DIE		REPLACEMENT DRAW STUD		REPLACEMENT BALL BEARING NUT		
PUNCH, DIE & DRAW STUD	CONDUIT & ACTUAL	Ø INCH		Ø mm	PG	ISO	MILD STEEL	WEIGHT		CAT. NO.	UPC NO.	CAT. NO.	UPC NO.	CAT. NO.	UPC NO.	CAT. NO.	UPC NO.		
CAT. NO.	UPC NO.	PIPE SIZE					GA.	mm	LBS.	g									
730-1/2	02408	—	1/2	0.500	12.7	7	—	16	1.5	.1	46	1760AV	06996	1759AV	04235	1675AV	04218	—	—
730-9/16	02433	—	9/16	0.563	14.3	—	—	16	1.5	.1	46	1754AV	04230	1753AV	04229	1675AV	04218	—	—
21115	21115	—	—	0.598	15.2	9	—	14	2.0	.3	137	21316	21316	32002	32002	00042	00042	—	—
730-5/8	02409	—	5/8	0.625	15.9	—	—	16	1.5	.2	91	1742AV	04223	1743AV	04224	1675AV	04218	—	—
35192	35192	—	—	0.638	16.2	—	16	14	2.0	.3	137	35193	35193	35162	35162	00042	00042	—	—
730BB-11/16	25340	—	11/16	0.688	17.5	—	—	14	2.0	.3	137	1752AV	04228	1751AV	04227	00042	00042	—	—
730EBB-18.6	18886	—	—	0.732	18.6	11	—	14	2.0	.3	137	17700	17700	32003	32003	00042	00042	—	—
730BB-3/4	20667	—	3/4	0.750	19.1	—	—	14	2.0	.3	137	113AV	03998	114AV	03999	00042	00042	—	—
730EBB - 20.4	18887	—	—	0.803	20.4	13	20	14	2.0	.3	137	17697	17697	32004	32004	00042	00042	—	—
730BB-13/16	20668	—	13/16	0.812	20.6	—	—	14	2.0	.3	137	1745AV	04226	1744AV	04225	00042	00042	—	—
71BB	22563	1/2"	7/8	0.885	22.5	16	—	10	3.5	.4	182	121AV	04006	14722	14722	00042	00042	—	—
730BB-15/16	25341	—	15/16	0.937	23.8	—	—	14	2.0	.5	227	1762AV	04238	1761AV	04237	00042	00042	—	—
730BB-1	20670	—	1	1.000	25.4	—	25	14	2.0	.5	227	87AV	03986	35164	35164	00042	00042	—	—
730BB-1-1/16	25342	—	1-1/16	1.063	27.0	—	—	14	2.0	.5	227	1763AV	04240	1764AV	04242	00042	00042	—	—
72BB	22564	3/4"	—	1.115	28.3	21	—	10	3.5	.9	409	123AV	04008	124AV	06972	249AVBB	04040	—	—
36910	36910	3/4"	—	1.115	28.3	21	—	14	2.0	.6	273	36882	36882	32006	32006	00042	00042	—	—
730BB-1-1/8	20671	—	1-1/8	1.125	28.6	—	—	14	2.0	.6	273	91AV	03990	92AV	03991	00042	00042	—	—
36506	36506	—	1-7/32	1.210	30.5	—	—	16	1.5	.6	273	36282	36282	36279	36279	00042	00042	—	—
730BB-1-1/4	20673	—	1-1/4	1.250	31.8	—	—	16	1.5	.7	318	117AV	04002	118AV	04003	00042	00042	—	—
24476	24476	—	—	1.280	32.5	—	32	10	3.5	1	454	24459	24459	35168	35168	249AVBB	04040	—	—
730BB-1-5/16	25344	—	1-5/16	1.313	33.4	—	—	16	1.5	.7	318	1747AV	06587	1746AV	06586	00042	00042	—	—
73BB	22565	1"	—	1.362	34.6	—	—	10	3.5	1.1	499	125AV	04010	126AV	04011	249AVBB	04040	—	—
730BB-1-3/8	25427	—	1-3/8	1.375	34.9	—	—	10	3.5	1.1	499	3205AV	04734	3206AV	04735	249AVBB	04040	—	—
730EBB-37	18890	—	—	1.457	37.0	29	—	10	3.5	1	454	18331	18331	32008	32008	249AVBB	04040	—	—
730BB-1-1/2	25428	—	1-1/2	1.500	38.1	—	—	10	3.5	1.2	545	3207AV	04736	3208AV	07044	249AVBB	04040	—	—
24477	24477	—	—	1.595	40.5	—	40	10	3.5	1.3	590	24462	24462	35159	35159	249AVBB	04040	—	—
730BB-1-5/8	25349	—	1-5/8	1.625	41.3	—	—	10	3.5	1.4	636	1794AV	04251	1793AV	04250	249AVBB	04040	—	—
74BB	22566	1-1/4"	1-11/16	1.701	43.2	—	—	10	3.5	1.4	636	127AV	06974	128AV	04013	249AVBB	04040	—	—
730BB-1-3/4	25350	—	1-3/4	1.750	44.5	—	—	10	3.5	1.5	681	1816AV	04257	1815AV	04256	249AVBB	04040	—	—
730EBB-47	18891	—	—	1.850	47.0	—	—	10	3.5	1.7	772	17687	17687	32009	32009	304AVBB	04042	—	—
730BB-1-7/8	25351	—	1-7/8	1.875	47.6	—	—	10	3.5	1.9	862	1791AV	04248	1792AV	04249	304AVBB	04042	—	—
75BB	22567	1-1/2"	1-15/16	1.951	49.6	—	—	10	3.5	2	908	439AV	06978	440AV	04061	304AVBB	04042	—	—
730BB-2	20676	—	2	2.000	50.8	—	50	10	3.5	1.9	862	1756AV	04232	35161	35161	304AVBB	04042	—	—
730BB-2-1/8	20678	—	2-1/8	2.125	54.0	42	—	10	3.5	2.2	998	1783AV	04245	36173	36173	304AVBB	04042	—	—
730BB-2-1/4	25360	—	2-1/4	2.250	57.2	—	—	10	3.5	2.6	1180	437AV	04058	438AV	04059	304AVBB	04042	—	—
730EBB-60	18892	—	—	2.362	60.0	48	—	10	3.5	2.6	1180	17690	17690	32011	32011	304AVBB	04042	—	—
76BB	22568	2"	2-3/8	2.416	61.5	—	—	10	3.5	3	1361	441AV	04062	442AV	04063	304AVBB	04042	—	—
730BB-2-1/2	20679	—	2-1/2	2.500	63.5	—	63	10	3.5	3	1361	1758AV	04234	1757AV	04233	304AVBB	04042	—	—
730PBB-2-5/8	21214	—	2-5/8	2.625	66.7	—	—	10	3.5	5.1	2314	1795AV	04252	1796AV	06997	1434AV	04188	1433AVBB	04187
730BB-2-3/4	25361	—	2-3/4	2.750	69.9	—	—	10	3.5	4.8	2178	1790AV	04247	1789AV	04246	1434AV	04188	1433AVBB	04187
730MBB	25383	—	—	2.781	70.6	—	—	10	3.5	3.8	1724	730101A	02445	730100A	02443	304AVBB	04042	—	—
738BB	19975	2-1/2"	2-7/8	2.914	74.0	—	—	10	3.5	5	2268	1429AV	04175	1430AV	04177	1434AV	04188	1433AVBB	04187
730BB-3	25372	—	3	3.000	76.2	—	—	10	3.5	6.1	2767	1821AV	04259	1820AV	04258	1434AV	04188	1433AVBB	04187
730TBB	25403	—	3-1/8	3.125	79.4	—	—	10	3.5	6	2722	1798AV	06363	1797AV	06362	1434AV	04188	1433AVBB	04187
730EBB-82	18635	—	—	3.228	82.0	—	—	10	3.5	6.3	2858	18905	18905	18906	18906	1434AV	04188	1433AVBB	04187
739BB	19976	3"	3-1/2	3.539	89.9	—	—	10	3.5	5.9	2677	1431AV	04180	1432AV	04183	1434AV	04188	1433AVBB	04187
730PBB-3-3/4	21216	—	3-3/4	3.750	95.3	—	—	10	3.5	7.7	3493	4640AV	05265	4641AV	05266	1434AV	04188	1433AVBB	04187
741BB*	19977	3-1/2"	4	4.044	102.7	—	—	10	3.5	10	4536	2982AV	04653	2981AV	04652	3026AV	04679	3036AVBB	04685
742BB*	19978	4"	4-1/2	4.544	115.4	—	—	10	3.5	11.4	5172	2984AV	04655	2983AV	04654	3026AV	04679	3036AVBB	04685
730EBB-120*	21519	—	—	4.724	120.0	—	—	10	3.5	13	5897	21489	21489	21491	21491	3026AV	04679	3036AVBB	04685
743BB*	19980	5"	5-5/8	5.675	144.1	—	—	10	3.5	19	8619	5135AV	05447	5136AV	05448	3026AV	04679	3036AVBB	04685



*CAT. NO. UPC NO. DESCRIPTION
 3037AV 04686  Bushing for 3-1/2" (conduit hole size) and larger punches with manual operation

 = REPLACEMENT PART  = ACCESSORY

STANDARD KNOCKOUT PUNCH KITS

Standard Round Manual Knockout Punch Kits



737BB



735BB

Wrenches Sold Separately
for kits 737BB, 735BB and 7304BB



7304 For 11 Ton
Hydraulic Drivers

- Assortment of commonly used round standard knockout punches, packaged to meet the contractor's needs.
- High-impact, rugged plastic carrying case.

CAT. NO.	UPC NO.	DESCRIPTION	CAPACITY		WEIGHT	
			MILD STEEL		LBS.	kg.
735BB	19973	1/2" - 1-1/4" Conduit Size Knockout Punch Kit (Manual Round Standard)	10	3.5	2.5	1.1
737BB	19974	1-1/2" - 2" Conduit Size Knockout Punch Kit (Manual Round Standard)	10	3.5	4.4	2.0
7304	02815	Standard Punches and Dies (no draw studs) for 2-1/2" through 4" Conduit, in Plastic Case	10	3.5	21	9.5

735BB/19973 KNOCKOUT PUNCH KIT INCLUDES

CAT. NO.	UPC NO.	DESCRIPTION	HOLE SIZE	
			ACTUAL Ø INCH	Ø mm
721-1/2	31756	R 1/2" Conduit Size Slug-Buster® Punch	7/8	0.885 22.5
14722	14722	R 1/2" Conduit Size Die	7/8	0.885 22.5
00042	00042	R 3/8" x 1-9/16" Draw Stud		
123AV	04008	R 3/4" Conduit Size Punch	—	1.115 28.3
124AV	06972	R 3/4" Conduit Size Die	—	1.115 28.3
125AV	04010	R 1" Conduit Size Punch	—	1.362 34.6
126AV	04011	R 1" Conduit Size Die	—	1.362 34.6
127AV	06974	R 1-1/4" Conduit Size Punch	1-11/16	1.701 43.2
128AV	04013	R 1-1/4" Conduit Size Die	1-11/16	1.701 43.2
249AVBB	04040	R 3/4" x 2-1/8" Draw Stud		
31880	31880	R Plastic Case		

737BB/19974 KNOCKOUT PUNCH KIT INCLUDES

CAT. NO.	UPC NO.	DESCRIPTION	HOLE SIZE	
			ACTUAL Ø INCH	Ø mm
439AV	06978	R 1-1/2" Conduit Size Punch	1-15/16	1.951 49.6
440AV	04061	R 1-1/2" Conduit Size Die	1-15/16	1.951 49.6
441AV	04062	R 2" Conduit Size Punch	2-3/8	2.416 61.5
442AV	04063	R 2" Conduit Size Die	2-3/8	2.416 61.5
304AVBB	04042	R 3/4" x 2-15/16" Draw Stud		
32012	32012	R Plastic Case		

7304/02815 KNOCKOUT PUNCH KIT INCLUDES

CAT. NO.	UPC NO.	DESCRIPTION	HOLE SIZE	
			ACTUAL Ø INCH	Ø mm
1429AV	04175	R 2-1/2" Conduit Size Punch	2-7/8	2.914 74.0
1430AV	04177	R 2-1/2" Conduit Size Die	2-7/8	2.914 74.0
1431AV	04180	R 3" Conduit Size Punch	3-1/2	3.539 89.9
1432AV	04183	R 3" Conduit Size Die	3-1/2	3.539 89.9
2982AV	04978	R 3-1/2" Conduit Size Punch	4	4.044 102.7
2981AV	04652	R 3-1/2" Conduit Size Die	4	4.044 102.7
2984AV	04655	R 4" Conduit Size Punch	4-1/2	4.544 115.4
2983AV	04654	R 4" Conduit Size Die	4-1/2	4.544 115.4
30236	30236	R Plastic Case		

NOTE: See Standard Round Knockout Punches on pages 43 and 44 for listing of individual punch units, punches, dies and draw studs.

Standard Round Manual Industrial Punch Kit



Wrench Sold Separately

SPECIFICATIONS

- Capacity** 1-1/4" Punch - 16 gauge (1.5 mm) mild steel.
3/4", 1", and 1-1/8" Punches - 14 gauge (2.0 mm) mild steel.
7/8" and 1-1/2" Punches 10 gauge (3.5 mm) mild steel.
- Operation** Manual - Wrench not included.

- Includes most popular sizes for industrial applications.
- Time-saving tool for maintenance, repair and operation applications.
- Convenient steel carrying case.
- Ball bearing drive screw for easy manual operation or use with ratchet and hydraulic drivers.

CAT. NO.	UPC NO.	DESCRIPTION
39860	39860	3/4" - 1-1/2" Hole Size Manual Industrial Punch Kit

39860 MANUAL INDUSTRIAL KNOCKOUT PUNCH KIT INCLUDES

CAT. NO.	UPC NO.	DESCRIPTION	HOLE SIZE	
			Ø INCH	Ø mm
113AV	03998	R 3/4" Punch	3/4	19.1
114AV	03999	R 3/4" Die	3/4	19.1
121AV	04006	R 7/8" Punch	7/8	22.5
14722	14722	R 7/8" Die	7/8	22.5
87AV	03986	R 1" Punch	1	25.4
35164	35164	R 1" Die	1	25.4
91AV	03990	R 1-1/8" Punch	1-1/8	28.6
92AV	03991	R 1-1/8" Die	1-1/8	28.6
117AV	04002	R 1-1/4" Punch	1-1/4	31.8
118AV	04003	R 1-1/4" Die	1-1/4	31.8
3207AV	04736	R 1-1/2" Punch	1-1/2	38.1
3208AV	07044	R 1-1/2" Die	1-1/2	38.1
00042	00042	R 3/8" BB Draw Stud		
249AVBB	04040	R 3/4" BB Draw Stud		
19193	19193	R Steel Storage Box		

International Tel: +1.815.397.7070
Fax: +1.815.397.9247

Canada Tel: 800.435.0786
Fax: 800.524.2853

USA Tel: 800.435.0786
Fax: 800.451.2632

Standard Round Manual Knockout Punch Kits - Metric



- 1" (25.4 mm) Hex ratchet wrench allows use with both 3/8" (9.5 mm) and 3/4" (19.1 mm) draw studs.
- 12.7 mm Kwik Stepper® step bit included.
- Plastic carrying case included.

CAT. NO.	UPC NO.	DESCRIPTION	WEIGHT	
			LBS.	kg.
36686	36686	Pg-9 through 30.5 mm Manual Round Standard Knockout Punch Kit	5.2	2.3
36687	36687	Pg-9 through Pg-48 Manual Round Standard Knockout Punch Kit	8.8	4
36688	36688	ISO-16 through ISO-40 Manual Round Standard Knockout Punch Kit	5.2	2.3
36689	36689	ISO-16 through ISO-63 Manual Round Standard Knockout Punch Kit	8.8	4
7309E	32804	Pg-9 through Pg-48 Standard Knockout Pg. Punch Kit. Replacement Kit Packaged in Carton Without Plastic Case.	8.8	4

SPECIFICATIONS

Operation Manual - Ratchet wrench included

CAT. NO.	UPC NO.	DESCRIPTION	HOLE SIZE				CAPACITY		KIT CAT./UPC NO.						
			ACTUAL		PG	ISO	MILD STEEL		36686	36687	36688	36689	7309E		
			Ø INCH	Ø mm			GA	mm							
21316	21316	Pg-9 Punch	—	0.598	15.2	9	—	14	2.0						✓
31969	31969	Pg-9 Slug-Buster® Punch	—	0.598	15.2	9	—	14	2.0	✓	✓				✓
32002	32002	Pg-9 Die	—	0.598	15.2	9	—	14	2.0	✓	✓				✓
17700	17700	Pg-11 Punch	—	0.732	18.6	11	—	14	2.0	✓	✓				✓
32003	32003	Pg-11 Die	—	0.732	18.6	11	—	14	2.0	✓	✓				✓
17697	17697	Pg-13 Punch	—	0.803	20.4	13	20	14	2.0	✓	✓	✓	✓		✓
32004	32004	Pg-13 Die	—	0.803	20.4	13	20	14	2.0	✓	✓	✓	✓		✓
121AV	04006	Pg-16 Punch	7/8	0.885	22.5	16	—	10	3.5	✓	✓				✓
14722	14722	Pg-16 Die	7/8	0.885	22.5	16	—	10	3.5	✓	✓				✓
36882	36882	Pg-21 Punch	—	1.115	28.3	21	—	10	3.5	✓	✓				✓
32006	32006	Pg-21 Die	—	1.115	28.3	21	—	10	3.5	✓	✓				✓
36282	36282	30.5 mm Punch	1-7/32	1.210	30.5	—	—	16	1.5	✓	✓				✓
36279	36279	30.5 mm Die	1-7/32	1.210	30.5	—	—	16	1.5	✓	✓				✓
18331	18331	Pg-29 Punch	—	1.457	37.0	29	—	10	3.5		✓				✓
32008	32008	Pg-29 Die	—	1.457	37.0	29	—	10	3.5		✓				✓
17687	17687	Pg-36 Punch	—	1.850	47.0	36	—	10	3.5		✓				✓
32009	32009	Pg-36 Die	—	1.850	47.0	36	—	10	3.5		✓				✓
17690	17690	Pg-48 Punch	—	2.362	60.0	48	—	10	3.5		✓				✓
32011	32011	Pg-48 Die	—	2.362	60.0	48	—	10	3.5		✓				✓
35193	35193	ISO-16 Punch	—	0.638	16.2	—	16	14	2.0			✓	✓		
35162	35162	ISO-16 Die	—	0.638	16.2	—	16	14	2.0			✓	✓		
87AV	03986	ISO-25 Punch	1	1.000	25.4	—	25	14	2.0			✓	✓		
35164	35164	ISO-25 Die	1	1.000	25.4	—	25	14	2.0			✓	✓		
24459	24459	ISO-32 Punch	—	1.280	32.5	—	32	10	3.5			✓	✓		
35168	35168	ISO-32 Die	—	1.280	32.5	—	32	10	3.5			✓	✓		
24462	24462	ISO-40 Punch	—	1.595	40.5	—	40	10	3.5			✓	✓		
35159	35159	ISO-40 Die	—	1.595	40.5	—	40	10	3.5			✓	✓		
1756AV	04232	ISO-50 Punch	2	2.000	50.8	—	50	10	3.5				✓		
35161	35161	ISO-50 Die	2	2.000	50.8	—	50	10	3.5				✓		
1758AV	04234	ISO-63 Punch	2-1/2	2.500	63.5	—	63	10	3.5				✓		
1757AV	04233	ISO-63 Die	2-1/2	2.500	63.5	—	63	10	3.5				✓		
249AVBB	04040	Draw Stud – 3/4" x 2-1/8"												✓	
304AVBB	04042	Draw Stud – 3/4" x 2-15/16"												✓	
34941	34941	Ratchet Wrench – 1" Hex								✓	✓	✓	✓		
34410	34410	Kwik Stepper® Step Bit 1/2" (12.7 mm)								✓	✓	✓	✓		
00042	00042	Ball Bearing Draw Stud with 1" Hex Head, 3/8" x 1-5/8"								✓	✓	✓	✓		
36685	36685	Plastic Case								✓	✓	✓	✓		

R = REPLACEMENT PART **A** = ACCESSORY

ELECTRIC & BATTERY-POWERED KNOCKOUT KITS

Gator® Plus Battery-Powered Knockout Punch Driver Kits



LS6011A

- Punches a hole for 2" conduit (61.5 mm) in only 12 seconds.
- Angled pistol grip allows easy one-handed control and positioning.
- Tool senses when the hole is completely punched and automatically shuts off to prevent damage to the punch and die.
- Develops 6.7 tons of hydraulic force, capable of punching up to 2" conduit (61.5 mm) size holes in 10-gauge (3.5 mm) mild steel and 12-gauge (2.5 mm) stainless steel.
- Three choices of battery chargers – 115 volt, 220 volt, or 12 volt. Punches approximately (80) 1/2" conduit size holes or (40) 2" conduit size holes in 10-gauge mild steel per battery charge.
- U.S. Patents #6,065,326, and #6,206,663.

SPECIFICATIONS

Weight (driver with battery only)	8.25 lbs. (3.7 kg)
Overall Length (ram retracted)	10.3 in. (262 mm)
Height	11.5 in. (292 mm)
Maximum Punch Force	6.7 tons (60 kN)
Maximum Round Punch Size (in 10 gauge mild steel)	2.42 in. dia. (61.5 mm dia)
Maximum Square Punch Size (in 10 gauge mild steel)	2-11/16 in. x 2-11/16 in. (68.0 x 68.0 mm)
Maximum Rectangular Punch Size (in 10 gauge mild steel)	1.378 x 2.559 in. (35.0 x 65.0 mm)
Maximum Ram Travel	0.87 in (22 mm)
Charging Time	Approximately 1 hour
Battery Voltage	12 volts NiCd

CAT. NO.	UPC NO.	DESCRIPTION	WEIGHT LBS.	kg.
LS6011A	03557	Battery-powered driver with 115 volt charger, 2 batteries, 2 draw studs, 1 adapter, 1 spacer and case	23	10.4
LS6012A	03558	Battery-powered driver with 12 volt charger, 2 batteries, 2 draw studs, 1 adapter, 1 spacer and case	23	10.4
LS6022A	03559	Battery-powered driver with 220 volt charger, 2 batteries, 2 draw studs, 1 adapter, 1 spacer and case	23	10.4
LS6011B	04311	Battery-powered driver with 115 volt charger, 2 batteries, 1/2" through 2" Slug-Buster® conduit size punches, 2 draw studs, 1 adapter, 1 spacer and case	27	12.2
LS6012B	04661	Battery-powered driver with 12 volt charger, 2 batteries, 1/2" through 2" Slug-Buster® conduit size punches, 2 draw studs, 1 adapter, 1 spacer and case	27	12.2
LS6022B	04312	Battery-powered driver with 220 volt charger, 2 batteries, 1/2" through 2" Slug-Buster® conduit size punches, 2 draw studs, 1 adapter, 1 spacer and case	27	12.2
02999	02999	12V NiCd Battery		
MKLS60	05956	Carrying Case		

See page 50 for complete parts list for all kits.

STEEL CAPACITIES FOR CONDUIT SIZES

STUD AND ACCESSORIES	STANDARD PUNCHES AND SLUG-BUSTERS®						SLUG-SPLITTERS®						Electronic Connector Punches RS-232, 229, 231, 234, 238	
	1/2" CON.	3/4"	1-7/32" CON.	1" CON.	1-1/4" CON.	1-1/2" CON.	2" CON.	1/2" CON.	3/4"	1-7/32" CON.	1" CON.	1-1/4" CON.		1-1/2" CON.
1614SS Draw Stud 1924AA Spacer 33967 Adapter	Ø 0.885" 22.5mm	Ø 1.115" 28.3mm	Ø 1.210" 30.5mm	Ø 1.362" 34.6mm	Ø 1.701" 43.2mm	Ø 1.951" 49.6mm	Ø 2.415" 61.5mm	Ø 0.885" 22.5mm	Ø 1.115" 28.3mm	Ø 1.210" 30.5mm	Ø 1.362" 34.6mm	Ø 1.701" 43.2mm	Ø 1.951" 49.6mm	Ø 2.416" 61.5mm
1924AA Spacer ① 29451 7/16" Draw Stud														
1924AA Spacer 31872 3/4" Draw Stud														
31872 3/4" Draw Stud														
33967 Adapter														

① 29451 sold separately. See page 64 for ordering information.

10 GA. (0.1345" [3.5 mm]) MILD STEEL
 10 GA. (0.1345" [3.5 mm]) STAINLESS STEEL
 12 GA. (0.1046" [2.5 mm]) STAINLESS STEEL
 16 GA. (0.0598" [1.5 mm]) MILD STEEL AND 1/8" ALUMINUM

R = REPLACEMENT PART A = ACCESSORY

International Tel: +1.815.397.7070
Fax: +1.815.397.9247

Canada Tel: 800.435.0786
Fax: 800.524.2853

USA Tel: 800.435.0786
Fax: 800.451.2632

Gator® Plus Corded Knockout Punch Driver Kits



- Punches a hole for 2" conduit (61.5 mm) in only 12 seconds.
- Angled pistol grip allows easy one-handed control and positioning.
- Tool senses when the hole is completely punched and automatically shuts off to prevent damage to the punch and die.
- Develops 6.7 tons of hydraulic force, capable of punching up to 2" conduit (61.5 mm) size holes in 10-gauge (3.5 mm) mild steel and 12-gauge (2.5 mm) stainless steel.
- Operates directly from 120V/60Hz or 230V/50Hz electrical outlets. No need to charge batteries or worry about running out of power.
- Equipped with 15-foot (5 m) cord. Can be used with extension cords.
- U.S. Patents #6,065,326 and #6,206,663.

SPECIFICATIONS

Weight (driver with battery only)	8.25 lbs. (3.7 kg)
Overall Length (ram retracted)	10.3 in. (262 mm)
Height	11.5 in. (292 mm)
Maximum Punch Force	6.7 tons (60 kN)
Maximum Round Punch Size (in 10 gauge mild steel)	2.42 in. dia. (61.5 mm dia)
Maximum Square Punch Size (in 10 gauge mild steel)	2-11/16 in. x 2-11/16 in. (68.0 x 68.0 mm)
Maximum Rectangular Punch Size (in 10 gauge mild steel)	1.378 x 2.559 in. (35.0 x 65.0 mm)
Maximum Ram Travel	0.87 in (22 mm)
Operating Voltage	120V, 60Hz; 230V, 50Hz

CAT. NO.	UPC NO.	DESCRIPTION	WEIGHT	
			LBS.	kg
CLS6011A	01496	Corded Driver, 120 Volts/60Hz, with 2 Draw Studs, 1 Adapter, 1 Spacer and Case.	23	10.4
CLS6022A	01497	Corded Driver, 230 Volts/50Hz, with 2 Draw Studs, 1 Adapter, 1 Spacer and Case.	23	10.4
CLS6011B	01498	Corded Driver, 120 Volts/60Hz, with 1/2" through 2" Slug-Buster® Conduit Size Punches, 2 Draw Studs, 1 Adapter, 1 Spacer and Case.	23	10.4
CLS6022B	01499	Corded Driver, 230 Volts/50Hz, with 1/2" through 2" Slug-Buster Conduit Size Punches, 2 Draw Studs, 1 Adapter, 1 Spacer and Case.	27	12.2
MKNLS60	01686	Carrying Case		

See page 50 for complete parts list for all kits.

STEEL CAPACITIES FOR CONDUIT SIZES

STUD AND ACCESSORIES	STANDARD PUNCHES AND SLUG-BUSTERS®							SLUG-SPLITTERS®					Electronic Connector Punches RS-232, 229, 231, 234, 238		
	1/2"	3/4"	1-7/32"	1"	1-1/4"	1-1/2"	2"	1/2"	3/4"	1-7/32"	1"	1-1/4"		1-1/2"	2"
	CON.	CON.	CON.	CON.	CON.	CON.	CON.	CON.	CON.	CON.	CON.	CON.		CON.	CON.
	Ø 0.885" 22.5mm	Ø 1.115" 28.3mm	Ø 1.210" 30.5mm	Ø 1.362" 34.6mm	Ø 1.701" 43.2mm	Ø 1.951" 49.6mm	Ø 2.415" 61.5mm	Ø 0.885" 22.5mm	Ø 1.115" 28.3mm	Ø 1.210" 30.5mm	Ø 1.362" 34.6mm	Ø 1.701" 43.2mm	Ø 1.951" 49.6mm	Ø 2.416" 61.5mm	
1614SS Draw Stud															
1924AA Spacer															
33967 Adapter															
1924AA Spacer ^①															
29451 7/16" Draw Stud															
1924AA Spacer															
31872 3/4" Draw Stud															
31872 3/4" Draw Stud															
33967 Adapter															

^① 29451 sold separately. See page 64 for ordering information.

- 10 GA. (0.1345" [3.5 mm]) MILD STEEL
- 10 GA. (0.1345" [3.5 mm]) STAINLESS STEEL
- 12 GA. (0.1046" [2.5 mm]) STAINLESS STEEL
- 16 GA. (0.0598" [1.5 mm]) MILD STEEL AND 1/8" ALUMINUM

Battery-Powered Knockout Punch Driver Kits Parts List

CAT. NO.	UPC NO.	DESCRIPTION	HOLE SIZE				KIT CAT./UPC NO.				
			CONDUIT & PIPE SIZE	ACTUAL		PG	LS6011A/03557	LS6011B/04311	CLS6011A	CLS6011B	
				Ø INCH	Ø mm		LS6012A/03558	LS6012B/04661	CLS6022A	CLS6022B	
721-1/2	31756	1/2" Conduit Size Slug-Buster® Punch	1/2"	7/8	0.885	22.5	16		✓		✓
14722	14722	1/2" Conduit Size Die	1/2"	7/8	0.885	22.5	16		✓		✓
721-3/4	31757	3/4" Conduit Size Slug-Buster Punch	3/4"	—	1.115	28.3	21		✓		✓
124AV	06972	3/4" Conduit Size Die	3/4"	—	1.115	28.3	21		✓		✓
721-1	31758	1" Conduit Size Slug-Buster Punch	1"	—	1.362	34.6	—		✓		✓
126AV	04011	1" Conduit Size Die	1"	—	1.362	34.6	—		✓		✓
721-1-1/4	31759	1-1/4" Conduit Size Slug-Buster Punch	1-1/4"	1-11/16	1.701	43.2	—		✓		✓
128AV	04013	1-1/4" Conduit Size Die	1-1/4"	1-11/16	1.701	43.2	—		✓		✓
721-1-1/2	31760	1-1/2" Conduit Size Slug-Buster Punch	1-1/2"	1-15/16	1.951	49.6	—		✓		✓
440AV	04061	1-1/2" Conduit Size Die	1-1/2"	1-15/16	1.951	49.6	—		✓		✓
721-2	31761	2" Conduit Size Slug-Buster Punch	2"	2-3/8	2.416	61.5	—		✓		✓
442AV	04063	2" Conduit Size Die	2"	2-3/8	2.416	61.5	—		✓		✓
1614SS	30043	Draw Stud—3/8" x 2-13/16"						✓	✓	✓	✓
31872	31872	Draw Stud—3/4" x 4-1/8"						✓	✓	✓	✓
1924AA	03248	Spacer-Short						✓	✓	✓	✓
33967	33967	Stud Adapter—3/8"						✓	✓	✓	✓
01686	01686	Metal Case						✓	✓	✓	✓
MKLS60	05956	Case for LS60						✓	✓	✓	✓

Optional Accessories for LS6011B, LS6012B, and LS6022B (not included in kits)

29451	29451	Draw Stud—7/16" x 4-1/2" for Slug Splitter Stainless Steel Punches
-------	-------	--

 International Tel: +1.815.397.7070
 Fax: +1.815.397.9247

 Canada Tel: 800.435.0786
 Fax: 800.524.2853

 USA Tel: 800.435.0786
 Fax: 800.451.2632

HYDRAULIC KNOCKOUT KITS

Quick Draw® Hydraulic Punch Driver and Kits



7806SB
Quick Draw Kit



7704SB Flex Driver only



7906SB
Quick Draw 90 Kit



7706SB
Flex Driver Kit

The Quick Draw, Quick Draw 90®, and Quick Draw Flex feature:

- Compact, lightweight design for portability and fast, easy one-person operation.
- Develops 8 tons of hydraulic force for easy punching, even in 10-gauge stainless steel, depending on individual punch capacities.
- Quick Draw is perfect for fast, straight-on front panel punching.
- Quick Draw 90's right angle driver head rotates over 180 degrees for maximum flexibility in tight working areas.
- Quick Draw Flex allows unlimited driver orientation to simplify access to work area.
- Can be used with non-round punches within the capacity of the tool (adapter may be required).
- U.S. Patent #6,772,521.

CAT. NO.	UPC NO.	DESCRIPTION	WEIGHT	
			LBS.	kg.
7704SB	10475	Quick Draw Flex Driver, 2 Draw Studs, 1 Adapter, 1 Spacer and Case	12.1	5.5
7706SB	10476	Standard – Quick Draw Flex Driver, 1/2" through 2" Slug-Buster® Conduit Size Punches and Dies, 2 Draw Studs, 1 Adapter, 1 Spacer and Case	17.3	7.9
7804SB	34292	Quick Draw Driver, 2 Draw Studs, 1 Adapter, 1 Spacer and Case	10	4.5
7806SB	34293	Standard – Quick Draw Driver, 1/2" through 2" Slug-Buster Conduit Size Punches and Dies 2 Draw Studs, 1 Adapter, 1 Spacer and Case	14	6.4
7804E	34291	Metric – Quick Draw Driver, 2 Draw Studs, 1 Adapter, 1 Spacer and Case	9.4	4.3
7804ESB	35611	Metric – Quick Draw Driver, Slug-Buster Pg Punches and Dies 15.2 mm through 30.5 mm, 2 Draw Studs, 1 Adapter, 1 Spacer and Case	10.3	4.7
7804ISO	35614	Metric – Quick Draw Driver, Slug-Buster ISO Punches and Dies 16.2 mm through 40.5 mm, 2 Draw Studs, 1 Adapter, 1 Spacer and Case	11.4	5.2
7904SB	33794	Quick Draw 90 Driver, 2 Draw Studs, 1 Adapter, 1 Spacer and Case	10	4.5
7906SB	34300	Quick Draw 90 Driver, 1/2" through 2" Slug-Buster Conduit Size Punches and Dies, Draw Studs, 1 Adapter, 1 Spacer and Case	14	6.4
7904E	34299	Metric – Quick Draw 90 Driver, 2 Draw Studs, 1 Adapter, 1 Spacer and Case	11	5.0
7904ESB	35615	Metric – Quick Draw 90 Driver, Slug-Buster Pg Punches and Dies 15.2 mm through 30.5 mm, 2 Draw Studs, 1 Adapter, 1 Spacer and Case	11	5.0
7904ISO	35616	Metric – Quick Draw 90 Driver, Slug-Buster ISO Punches and Dies 16.2 mm through 40.5 mm, 2 Draw Studs, 1 Adapter, 1 Spacer and Case	12.2	5.5
34983	34983	Ⓜ Plastic Case		

See page 52 for complete parts list for all kits.

STEEL CAPACITIES FOR CONDUIT SIZES

REQUIRED DRAW STUD AND ACCESSORIES	STANDARD PUNCHES AND SLUG-BUSTERS®							SLUG-SPLITTERS®			
	1/2"	3/4"	1-7/32" OILTIGHT	1"	1-1/4"	1-1/2"	2"	1/2"	3/4"	1-7/32" OILTIGHT	1-1/4"
3/8" Draw Stud											
Spacer & 7/16" Draw Stud											
Spacer & 3/4" Draw Stud											
3/4" Draw Stud											

10 GA. MILD STEEL

10 GA. STAINLESS STEEL

= REPLACEMENT PART = ACCESSORY

Parts List for Quick Draw®, Quick Draw 90® and Quick Draw® Flex Kits

CAT. NO.	UPC NO.	DESCRIPTION	HOLE SIZE						KIT CAT./UPC NO.										
			CONDUIT & PIPE SIZE	ACTUAL		PG	ISO	7704SB/	7706SB/	7804E/	7804ESB/	7804ISO/	7804SB/	7806SB/	7904E/	7904ESB/	7904ISO/	7904SB/	7906SB/
				Ø INCH	Ø mm			10475	10476	34291	35611	35614	34292	34293	34299	35615	35616	33794	34300
721-1/2	31756	1/2" Conduit Size Slug-Buster® Punch	1/2"	7/8	0.885	22.5	16	—	✓				✓					✓	
14722	14722	1/2" Conduit Size Die	1/2"	7/8	0.885	22.5	16	—	✓				✓					✓	
721-3/4	31757	3/4" Conduit Size Slug-Buster Punch	3/4"	—	1.115	28.3	21	—	✓				✓					✓	
124AV	06972	3/4" Conduit Size Die	3/4"	—	1.115	28.3	21	—	✓				✓					✓	
721-1	31758	1" Conduit Size Slug-Buster Punch	1"	—	1.362	34.6	—	—	✓				✓					✓	
126AV	04011	1" Conduit Size Die	1"	—	1.362	34.6	—	—	✓				✓					✓	
721-1-1/4	31759	1-1/4" Conduit Size Slug-Buster Punch	1-1/4"	1-11/16	1.701	43.2	—	—	✓				✓					✓	
128AV	04013	1-1/4" Conduit Size Die	1-1/4"	1-11/16	1.701	43.2	—	—	✓				✓					✓	
721-1-1/2	31760	1-1/2" Conduit Size Slug-Buster Punch	1-1/2"	1-15/16	1.951	49.6	—	—	✓				✓					✓	
440AV	04061	1-1/2" Conduit Size Die	1-1/2"	1-15/16	1.951	49.6	—	—	✓				✓					✓	
721-2	31761	2" Conduit Size Slug-Buster Punch	2"	2-3/8	2.416	61.5	—	—	✓				✓					✓	
442AV	04063	2" Conduit Size Die	2"	2-3/8	2.416	61.5	—	—	✓				✓					✓	
31969	31969	Slug-Buster Punch	—	—	0.598	15.2	9	—							✓				
32002	32002	Die	—	—	0.598	15.2	9	—							✓				
31970	31970	Slug-Buster Punch	—	—	0.732	18.6	11	—							✓				
32003	32003	Die	—	—	0.732	18.6	11	—							✓				
31971	31971	Slug-Buster Punch	—	—	0.803	20.4	13	20							✓				
32004	32004	Die	—	—	0.803	20.4	13	20							✓				
721-1/2	31756	Slug-Buster Punch	1/2"	7/8	0.885	22.5	16	—							✓				
14722	14722	Die	1/2"	7/8	0.885	22.5	16	—							✓				
31973	31973	Slug-Buster Punch	3/4"	—	1.115	28.3	21	—							✓				
32006	32006	Die	3/4"	—	1.115	28.3	21	—							✓				
36284	36284	30.5 mm Slug-Buster Punch	—	1-7/32	1.210	30.5	—	—							✓				
36279	36279	30.5 mm Die	—	1-7/32	1.210	30.5	—	—							✓				
35163	35163	ISO-16 Slug-Buster Punch	—	—	0.638	16.2	—	16											
35162	35162	ISO-16 Die	—	—	0.638	16.2	—	16											
35165	35165	ISO-25 Slug-Buster Punch	—	1	1.000	25.4	—	25											
35164	35164	ISO-25 Die	—	1	1.000	25.4	—	25											
35169	35169	ISO-32 Slug-Buster Punch	—	—	1.280	32.5	—	32											
35168	35168	ISO-32 Die	—	—	1.280	32.5	—	32											
35158	35158	ISO-40 Slug-Buster Punch	—	—	1.595	40.5	—	40											
35159	35159	ISO-40 Die	—	—	1.595	40.5	—	40											
34288	34288	Quick Draw Hydraulic Punch Driver											✓	✓	✓	✓	✓	✓	
33786	33786	Quick Draw 90 Hydraulic Punch Driver																	
10383	10383	Quick Draw Flex Driver							✓	✓									
1614SS	30043	Draw Stud—3/8" x 2-13/16"							✓	✓	✓	✓	✓	✓	✓	✓	✓	✓	
31872	31872	Draw Stud—3/4" x 4-1/8"							✓	✓	✓	✓	✓	✓	✓	✓	✓	✓	
1924AA	03248	Spacer-Short							✓	✓	✓	✓	✓	✓	✓	✓	✓	✓	
33967	33967	Stud Adapter—3/8"							✓	✓	✓	✓	✓	✓	✓	✓	✓	✓	
35202	35202	Plastic Case											✓	✓	✓	✓	✓	✓	
34983	34983	Plastic Case											✓	✓	✓	✓	✓	✓	
10391	10391	Plastic Case							✓	✓								✓	

Punches and Dies

Draw Studs and Misc.

Optional Accessories for 7806SB, 7804E, 7804ESB, 7804ISO, 7906SB, 7904E, 7904ESB and 7904ISO Kits (not included in kits)

29451 | 29451 | 7/16" (11.1 mm) Stainless Steel Draw Stud

Holemaking

 International Tel: +1.815.397.7070
 Fax: +1.815.397.9247

 Canada Tel: 800.435.0786
 Fax: 800.524.2853

 USA Tel: 800.435.0786
 Fax: 800.451.2632

Slug-Buster® Ram and Foot Pump Hydraulic Driver Kits



- Foot operation frees both hands to position punch.
- Punches 10 times faster than wrench method.
- Will also drive 751 Cable Cutter head.
- Powerful 11-ton hydraulic ram.
- Can be used with most standard round, Slug-Buster and Slug-Splitter® punch sizes. (Not 1/2", 9/16" 5/8")
- Can be used with non-round punches (adapter may be required).

CAT. NO.	UPC NO.	DESCRIPTION	WEIGHT LBS. kg.
7625	25097	Driver, Foot Pump, Steel Case	37 17
7606SB	07173	Driver, Foot Pump, Slug-Buster Punches, Dies and Draw Studs for 1/2" through 2" Conduit, Steel Case	42 19
7610SB	07174	Driver, Foot Pump, Slug-Buster Punches, Dies and Draw Studs for 1/2" through 2" Conduit, Slug-Buster Punches and 2 1/2" through 4" Conduit Standard Round Punches	60 27

STEEL CAPACITIES FOR CONDUIT SIZES

REQUIRED DRAW STUD AND ACCESSORIES	STANDARD & SLUG-BUSTER® PUNCHES						STANDARD				SLUG-SPLITTERS®					
	1/2"	3/4"	1"	1-1/4"	1-1/2"	2"	2-1/2"	3"	3-1/2"	4"	1/2"	3/4"	1"	1-1/4"	1-1/2"	2"
3/4" Stud (03294), 3/8" Stud (30043) & Spacers	///															
3/4" Stud (03294), Long Spacer		///	///	///												
3/4" Stud (03294), Short Spacer					///	///										
3/4" Stud (03294)							///	///								
3/4" Stud (03294), & Sleeve (03170)									///	///						
7/16" Stud (29451)										///	///	///	///	///	///	///
3/4" Stud (29452)											///	///	///	///	///	///

/// 10 GA. MILD STEEL

/// 10 GA. STAINLESS STEEL

Holemaking

USA Tel: 800.435.0786
Fax: 800.451.2632

Canada Tel: 800.435.0786
Fax: 800.524.2853

International Tel: +1.815.397.7070
Fax: +1.815.397.9247

Ram and Foot Pump Kits Parts List

CAT. NO.	UPC NO.	DESCRIPTION	CONDUIT & PIPE SIZE	HOLE SIZE			PG	KIT CAT./UPC NO.		
				ACTUAL		7625/ 25097		7606SB/ 07173	7610SB/ 07174	
				Ø INCH	Ø mm					
721-1/2	31756	1/2" Conduit Size Slug-Buster® Punch	1/2"	7/8	0.885	22.5	16		1	1
14722	14722	1/2" Conduit Size Die	1/2"	7/8	0.885	22.5	16		1	1
721-3/4	31757	3/4" Conduit Size Slug-Buster Punch	3/4"	—	1.115	28.3	21	—	1	1
124AV	06972	3/4" Conduit Size Die	3/4"	—	1.115	28.3	21		1	1
721-1	31758	1" Conduit Size Slug-Buster Punch	1"	—	1.362	34.6	—		1	1
126AV	04011	1" Conduit Size Die	1"	—	1.362	34.6	—		1	1
721-1-1/4	31759	1-1/4" Conduit Size Slug-Buster Punch	1-1/4"	1-11/16	1.701	43.2	—		1	1
128AV	04013	1-1/4" Conduit Size Die	1-1/4"	1-11/16	1.701	43.2	—		1	1
721-1-1/2	31760	1-1/2" Conduit Size Slug-Buster Punch	1-1/2"	1-15/16	1.951	49.6	—		1	1
440AV	04061	1-1/2" Conduit Size Die	1-1/2"	1-15/16	1.951	49.6	—		1	1
721-2	31761	2" Conduit Size Slug-Buster Punch	2"	2-3/8	2.416	61.5	—		1	1
442AV	04063	2" Conduit Size Die	2"	2-3/8	2.416	61.5	—		1	1
1429AV	04175	2-1/2" Conduit Size Punch	2-1/2"	2-7/8	2.914	74.0	—			1
1430AV	04177	2-1/2" Conduit Size Die	2-1/2"	2-7/8	2.914	74.0	—			1
1431AV	04180	3" Conduit Size Punch	3"	3-1/2	3.539	89.9	—			1
1432AV	04183	3" Conduit Size Die	3"	3-1/2	3.539	89.9	—			1
2982AV	04653	3-1/2" Conduit Size Punch	3-1/2"	4	4.044	102.7	—			1
2981AV	04652	3-1/2" Conduit Size Die	3-1/2"	4	4.044	102.7	—			1
2984AV	04655	4" Conduit Size Punch	4"	4-1/2	4.544	115.4	—			1
2983AV	04654	4" Conduit Size Die	4"	4-1/2	4.544	115.4	—			1
746	17091	(A) Ram (includes 1 ea. of items B, C, and D)						1	1	1
2113AA	03294	(B) Draw Stud-3/4" x 5-3/8"						1	1	1
54167	54167	(C) Female Coupler-1/4"						1	1	1
54168	54168	(D) Dust Plug						1	1	1
1557AA	03170	(F) Punch Sleeve						1	1	1
1614SS	30043	(G) Draw stud-3/8"x 2-13/16"						2	2	2
15908	15908	(H) Spacer Group (includes 1 ea. of items I, J, and K)						1	1	1
1924AA	03248	(I) Spacer-Short						1	1	1
1925AA	03249	(J) Spacer-Medium						1	1	1
1926AA	06904	(K) Spacer-Long						1	1	1
34410	34410	(L) Kwik Stepper® Step Bit 1/2"						1	1	1
1725	31353	(S) Hydraulic Foot Pump (includes 1 ea. – 54167 female coupler and 54168 dust plug)						1	1	1
37729	37729	(T) High Pressure Hose Unit – 1/4" x 10'; filled with hydraulic oil; (includes the following 2 items)						1	1	1
54169	54169	Couplers						2	2	2
54170	54170	Dust Caps						2	2	2
23955	23955	(U) Steel case						1	1	1
25094	25094	Tray						1	1	1

RAM AND FOOT PUMP HYDRAULIC DRIVER PARTS IDENTIFICATION
(Match letters above to drawing.)

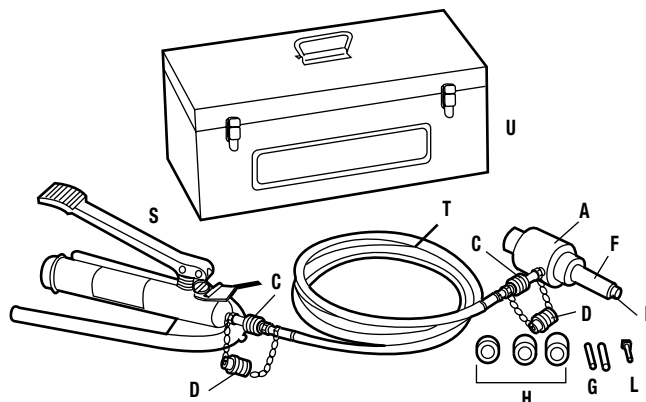

R = REPLACEMENT PART A = ACCESSORY

Ram and Hand Pump Kits Parts List

CAT. NO.	UPC NO.	DESCRIPTION	CONDUIT & PIPE SIZE	HOLE SIZE					KIT CAT./UPC NO.				
				ACTUAL		PG	ISO	7646/15906	7306SB/34360	7310SB/34361	7646PGSB/32799	38520	
				Ø INCH	Ø mm								
721-1/2	31756	1/2" Conduit Size Slug-Buster® Punch	1/2"	7/8	0.885	22.5	16	—	—	1	1	1	1
14722	14722	1/2" Conduit Size Die	1/2"	7/8	0.885	22.5	16	—	—	1	1	1	1
721-3/4	31757	3/4" Conduit Size Slug-Buster Punch	3/4"	—	1.115	28.3	21	—	—	1	1	—	1
124AV	06972	3/4" Conduit Size Die	3/4"	—	1.115	28.3	21	—	—	1	1	—	1
721-1	31758	1" Conduit Size Slug-Buster Punch	1"	—	1.362	34.6	—	—	—	1	1	—	1
126AV	04011	1" Conduit Size Die	1"	—	1.362	34.6	—	—	—	1	1	—	1
721-1-1/4	31759	1-1/4" Conduit Size Slug-Buster Punch	1-1/4"	1-11/16	1.701	43.2	—	—	—	1	1	—	1
128AV	04013	1-1/4" Conduit Size Die	1-1/4"	1-11/16	1.701	43.2	—	—	—	1	1	—	1
721-1-1/2	31760	1-1/2" Conduit Size Slug-Buster Punch	1-1/2"	1-15/16	1.951	49.6	—	—	—	1	1	—	1
440AV	04061	1-1/2" Conduit Size Die	1-1/2"	1-15/16	1.951	49.6	—	—	—	1	1	—	1
721-2	31761	2" Conduit Size Slug-Buster Punch	2"	2-3/8	2.416	61.5	—	—	—	1	1	—	1
442AV	04063	2" Conduit Size Die	2"	2-3/8	2.416	61.5	—	—	—	1	1	—	1
1429AV	04175	2-1/2" Conduit Size Punch	2-1/2"	2-7/8	2.914	74.0	—	—	—	—	1	—	1
1430AV	04177	2-1/2" Conduit Size Die	2-1/2"	2-7/8	2.914	74.0	—	—	—	—	1	—	1
1431AV	04180	3" Conduit Size Punch	3"	3-1/2	3.539	89.9	—	—	—	—	1	—	1
1432AV	04183	3" Conduit Size Die	3"	3-1/2	3.539	89.9	—	—	—	—	1	—	1
2982AV	04653	3-1/2" Conduit Size Punch	3-1/2"	4	4.044	102.7	—	—	—	—	1	—	1
2981AV	04652	3-1/2" Conduit Size Die	3-1/2"	4	4.044	102.7	—	—	—	—	1	—	1
2984AV	04655	4" Conduit Size Punch	4"	4-1/2	4.544	115.4	—	—	—	—	1	—	1
2983AV	04654	4" Conduit Size Die	4"	4-1/2	4.544	115.4	—	—	—	—	1	—	1
31969	31969	Slug-Buster Punch	—	—	0.598	15.2	9	—	—	—	—	1	—
32002	32002	Die	—	—	0.598	15.2	9	—	—	—	—	1	—
31970	31970	Slug-Buster Punch	—	—	0.732	18.6	11	—	—	—	—	1	—
32003	32003	Die	—	—	0.732	18.6	11	—	—	—	—	1	—
31971	31971	Slug-Buster Punch	—	—	0.803	20.4	13	20	—	—	—	1	—
32004	32004	Die	—	—	0.803	20.4	13	20	—	—	—	1	—
31973	31973	Slug-Buster Punch	3/4"	—	1.115	28.3	21	—	—	—	—	1	—
32006	32006	Die	3/4"	—	1.115	28.3	21	—	—	—	—	1	—
36284	36284	30.5 mm Slug-Buster Punch	—	1-7/32	1.210	30.5	—	—	—	—	—	1	—
36279	36279	30.5 mm Die	—	1-7/32	1.210	30.5	—	—	—	—	—	1	—
31975	31975	Slug-Buster Punch	—	—	1.457	37.0	29	—	—	—	—	1	—
32008	32008	Die	—	—	1.457	37.0	29	—	—	—	—	1	—
31976	31976	Slug-Buster Punch	—	—	1.850	47.0	36	—	—	—	—	1	—
32009	32009	Die	—	—	1.850	47.0	36	—	—	—	—	1	—
31978	31978	Slug-Buster Punch	—	—	2.362	60.0	48	—	—	—	—	1	—
32011	32011	Die	—	—	2.362	60.0	48	—	—	—	—	1	—
746	17091	Ram (includes following item)	—	—	—	—	—	—	—	1	1	1	1
2113AA	03294	Draw Stud—3/4" x 5-3/8"	—	—	—	—	—	—	—	1	1	1	1
1557AA	03170	Punch Sleeve	—	—	—	—	—	—	—	1	1	1	1
1614SS	30043	Draw Stud—3/8"x 2-13/16"	—	—	—	—	—	—	—	2	2	2	2
15908	15908	Spacer Group (includes 1 ea. of the following 3 items)	—	—	—	—	—	—	—	1	1	1	1
1924AA	03248	Spacer-Short	—	—	—	—	—	—	—	1	1	1	1
1925AA	03249	Spacer-Medium	—	—	—	—	—	—	—	1	1	1	1
1926AA	06904	Spacer-Long	—	—	—	—	—	—	—	1	1	1	1
34410	34410	Kwik Stepper® Step Bit 1/2"	—	—	—	—	—	—	—	1	1	1	1
767	13284	Hydraulic Hand Pump	—	—	—	—	—	—	—	1	1	1	1
06302	06302	High Pressure Hose—1/4" x 3'	—	—	—	—	—	—	—	1	1	1	1
30206	30206	Plastic Case	—	—	—	—	—	—	—	1	1	—	—
18402	18402	Steel Case	—	—	—	—	—	—	—	—	—	1	1
25094	25094	Punch Tray	—	—	—	—	—	—	—	—	—	1	—

Draw Studs and Misc.

R = REPLACEMENT PART A = ACCESSORY

Holemaking

USA Tel: 800.435.0786
Fax: 800.451.2632

Canada Tel: 800.435.0786
Fax: 800.524.2853

International Tel: +1.815.397.7070
Fax: +1.815.397.9247

Ram and Hand Pump Hydraulic Driver Kits (Inch and Metric)



- Fast, easy and simple to operate.
- Compact design for field use on construction sites and maintenance jobs.
- Punches 10 times faster than wrench method.
- Will also drive 751 Cable Cutter head.
- Can be used with most standard round Slug-Buster and Slug-Splitter® punches (not 1/2", 9/16", 5/8").
- Can be used with non-round punches (adapter may be required).
- 3-foot hose
- Powerful 11-ton hydraulic ram.

CAT. NO.	UPC NO.	DESCRIPTION	WEIGHT	
			LBS.	kg.
7646	15906	Driver with Hand Pump, Draw Studs, Spacer and Plastic Case	20	9.1
7306	15909	Driver, Hand Pump, Standard Punches, Dies and Draw Studs for 1/2" through 2" Conduit, Plastic Case	24	10.9
7306SB	34360	Driver, Hand Pump, Slug-Buster Punches, Dies and Draw Studs for 1/2" through 2" Conduit, Adapter, Spacers, Kwik Stepper® Step Bit and Plastic Case	24	10.9
7310	15910	Driver, Hand Pump, Standard Punches, Dies and Draw Studs and Spacers for 1/2" through 4" Conduit, Steel Case	54	24.5
7310SB	34361	Driver, Hand Pump, Slug-Buster Punches, Dies and Draw Studs for 1/2" through 2" and 2-1/2" through 4" Standard Conduit Size Punches, Dies and Draw Studs, Adapter, Spacers, Kwik Stepper Step Bit and Steel Case	54	24.5
7646Pg	27433	Metric – Driver, Hand Pump, Standard Pg Punches, Dies and Draw Studs and Spacers for 15.2 mm through 60.0 mm, Plastic Case	24	10.9
7646PgSB	32799	Metric – Driver, Slug-Buster Pg Punches, Dies and Draw Studs for 15.2 mm through 60.0 mm, Adapter, Spacers, Kwik Stepper Step Bit and Plastic Case	24	10.9
7304	02815	Standard Punch and Die Kit (no draw studs) for 2-1/2" through 4" Conduit, Plastic Case	21	9.5
38456	38456	Driver, Hand Pump, Standard Punches, Dies and Draw Studs and Spacers for 1/2" through 3" and 4" Conduit, Steel Case	48.4	22
38520	38520	Driver, Hand Pump, Slug-Buster Punches and Draw Studs for 1/2" through 3" and 4" Conduit, Adapter, Spacers, Kwik Stepper Step Bit and Steel Case	48	21.8

STEEL CAPACITIES FOR CONDUIT SIZES

REQUIRED DRAW STUD AND ACCESSORIES	STANDARD & SLUG-BUSTER® PUNCHES					STANDARD				SLUG-SPLITTERS®						
	1/2"	3/4"	1"	1-1/4"	1-1/2"	2"	2-1/2"	3"	3-1/2"	4"	1/2"	3/4"	1"	1-1/4"	1-1/2"	2"
3/4" Stud (03294), 3/8" Stud (30043) & Spacers	///															
3/4" Stud (03294), Long Spacer		///	///	///												
3/4" Stud (03294), Short Spacer					///											
3/4" Stud (03294)							///									
3/4" Stud (03294), & Sleeve (03170)								///								
7/16" Stud (29451)											///					
3/4" Stud (29452)												///	///	///	///	///

/// 10 GA. MILD STEEL ▨ 10 GA. STAINLESS STEEL

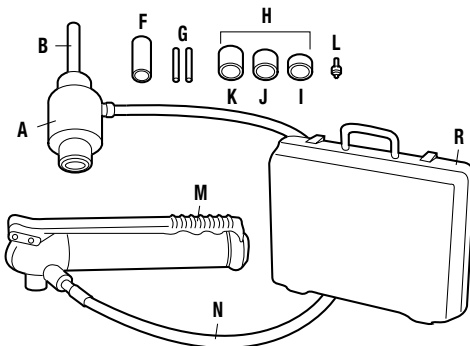

RAM AND HAND PUMP HYDRAULIC DRIVER PARTS IDENTIFICATION

KEY	CAT./UPC NO.	DESCRIPTION
A	746 / 17091	(R) Ram (includes Item B)
B	2113AA / 03294	(R) Draw Stud-3/4" x 5-3/8"
F	1557AA / 03170	(R) Punch Sleeve
G	1614SS / 30043	(R) Draw Stud-3/8" x 2-13/16"
H	15908	(R) Spacer Group (includes Items I, J and K)
I	1924AA / 03248	(R) Spacer-Short
J	1925AA / 03249	(R) Spacer-Medium
K	1926AA / 06904	(R) Spacer-Long
L	34410	(R) Kwik Stepper Step Bit 1/2"
M	767 / 13284	(R) Hydraulic Hand Pump
N	06302 / 06302	(R) High Pressure Hose-1/4" x 3'
R	30206	(R) Plastic Case

Ram and Hand Pump Kits Parts List

CAT. NO.	UPC NO.	DESCRIPTION	HOLE SIZE					KIT CAT./UPC NO.				
			CONDUIT & PIPE SIZE	ACTUAL		PG	7646/15906	7306/15909	7310/15910	7646PG/27433	38456	
				Ø INCH	Ø mm							
721-1/2	31756	1/2" Conduit Size Slug-Buster® Punch	1/2"	7/8	0.885	22.5	16		1	1		1
121AV	04006	1/2" Conduit Size Punch	1/2"	7/8	0.885	22.5	16				1	
14722	14722	1/2" Conduit Size Die	1/2"	7/8	0.885	22.5	16			1		1
123AV	04008	3/4" Conduit Size Punch	3/4"	—	1.115	28.3	21		1	1		1
124AV	06972	3/4" Conduit Size Die	3/4"	—	1.115	28.3	21		1	1		1
125AV	04010	1" Conduit Size Punch	1"	—	1.362	34.6	—		1	1		1
126AV	04011	1" Conduit Size Die	1"	—	1.362	34.6	—		1	1		1
127AV	06974	1-1/4" Conduit Size Punch	1-1/4"	1-11/16	1.701	43.2	—		1	1		1
128AV	04013	1-1/4" Conduit Size Die	1-1/4"	1-11/16	1.701	43.2	—		1	1		1
439AV	06978	1-1/2" Conduit Size Punch	1-1/2"	1-15/16	1.951	49.6	—		1	1		1
440AV	04061	1-1/2" Conduit Size Die	1-1/2"	1-15/16	1.951	49.6	—		1	1		1
441AV	04062	2" Conduit Size Punch	2"	2-3/8	2.416	61.5	—		1	1		1
442AV	04063	2" Conduit Size Die	2"	2-3/8	2.416	61.5	—		1	1		1
1429AV	04175	2-1/2" Conduit Size Punch	2-1/2"	2-7/8	2.914	74.0	—			1		1
1430AV	04177	2-1/2" Conduit Size Die	2-1/2"	2-7/8	2.914	74.0	—			1		1
1431AV	04180	3" Conduit Size Punch	3"	3-1/2	3.539	89.9	—			1		1
1432AV	04183	3" Conduit Size Die	3"	3-1/2	3.539	89.9	—			1		1
2982AV	04653	3-1/2" Conduit Size Punch	3-1/2"	4	4.044	102.7	—			1		
2981AV	04652	3-1/2" Conduit Size Die	3-1/2"	4	4.044	102.7	—			1		
2984AV	04655	4" Conduit Size Punch	4"	4-1/2	4.544	115.4	—			1		1
2983AV	04654	4" Conduit Size Die	4"	4-1/2	4.544	115.4	—			1		1
21316	21316	Punch	—	—	0.598	15.2	9				1	
32002	32002	Die	—	—	0.598	15.2	9				1	
17700	17700	Punch	—	—	0.732	18.6	11				1	
32003	32003	Die	—	—	0.732	18.6	11				1	
17697	17697	Punch	—	—	0.803	20.4	13				1	
32004	32004	Die	—	—	0.803	20.4	13				1	
36882	36882	Punch	3/4"	—	1.115	28.3	21				1	
32006	32006	Die	3/4"	—	1.115	28.3	21				1	
36282	36282	30.5 mm Punch	—	1-7/32	1.210	30.5	—				1	
36279	36279	30.5 mm Die	—	1-7/32	1.210	30.5	—				1	
18331	18331	Punch	—	—	1.457	37.0	29				1	
32008	32008	Die	—	—	1.457	37.0	29				1	
17687	17687	Punch	—	—	1.850	47.0	36				1	
32009	32009	Die	—	—	1.850	47.0	36				1	
17690	17690	Punch	—	—	2.362	60.0	48				1	
32011	32011	Die	—	—	2.362	60.0	48				1	
746	17091	Ram (includes following item)						1	1	1	1	1
2113AA	03294	Draw Stud—3/4" x 5-3/8"						1	1	1	1	1
1557AA	03170	Punch Sleeve						1	1	1	1	1
1614SS	30043	Draw Stud—3/8" x 2-13/16"						2	2	2	2	2
15908	15908	Spacer Group (includes 1 ea. of the following 3 items)										
1924AA	03248	Spacer-Short						1	1	1	1	1
1925AA	03249	Spacer-Medium						1	1	1	1	1
1926AA	06904	Spacer-Long						1	1	1	1	1
34410	34410	Kwik Stepper® Step Bit 1/2"						1	1	1	1	1
767	13284	Hydraulic Hand Pump						1	1	1	1	1
06302	06302	High Pressure Hose—1/4" x 3'						1	1	1	1	1
30206	30206	Plastic Case						1	1		1	
18402	18402	Steel Case								1		1

See Slug-Buster Knockout Punches on pages 36 and 37.

R = REPLACEMENT PART **A** = ACCESSORY

Holemaking

USA Tel: 800.435.0786
Fax: 800.451.2632

Canada Tel: 800.435.0786
Fax: 800.524.2853

International Tel: +1.815.397.7070
Fax: +1.815.397.9247

KNOCKOUT PARTS CABINETS

Knockout Punch Parts Assortment Cabinets



7360SB



7361SB

- Includes balanced stock of replacement parts in sturdy steel cabinets.

CAT. NO.	UPC NO.	DESCRIPTION
7360SB	34358	Knockout Punch Parts Assortment 1/2" - 2". Includes Metal Cabinet 14" High, 13" Wide and 14-3/4" Deep, with 4 Drawers.
7361SB	34359	Knockout Punch Parts Assortment 1/2" - 3". Includes Metal Cabinet 19-1/2" High, 27" Wide and 15" Deep with 4 Drawers.

7361SB/34359 PARTS CABINET INCLUDES

CAT. NO.	UPC NO.	DESCRIPTION	QTY.
721-1/2	31756	R Slug-Buster® 1/2" Conduit Punch	18
14722	14722	R 1/2" Conduit Die	12
721-3/4	31757	R Slug-Buster 3/4" Conduit Punch	6
124AV	06972	R 3/4" Conduit Die	6
721-1	31758	R Slug-Buster 1" Conduit Punch	6
126AV	04011	R 1" Conduit Die	6
721-1-1/4	31759	R Slug-Buster 1-1/4" Conduit Punch	6
128AV	04013	R 1-1/4" Conduit Die	6
721-1-1/2	31760	R Slug-Buster 1-1/2" Conduit Punch	3
440AV	04061	R 1-1/2" Conduit Die	3
721-2	31761	R Slug-Buster 2" Conduit Punch	3
442AV	04063	R 2" Conduit Die	2
1429AV	04175	R 2-1/2" Conduit Punch	1
1430AV	04177	R 2-1/2" Conduit Die	1
1431AV	04180	R 3" Conduit Punch	1
1432AV	04183	R 3" Conduit Die	1
00042	00042	R 3/8" Draw Stud	12
249AVBB	04040	R 3/4" Drive Screw	8
304AVBB	04042	R 3/4" Drive Screw	6
1434AV	04188	R 5-1/2" x 3/4" Drive Screw	1
1433AVBB	04187	R 1" Ball Bearing Nut	1
12097	12097	R 3/8" Adapter Screw	6
30227	30227	R 7/16" Adapter Screw	2
12098	12098	R 3/4" Adapter Screw	2
12099	12099	R 3/4" Ball Bearing Adapter Screw	1
1614SS	30043	R 3/8" Stainless Steel Adapter	20
2113AA	03294	R 3/4" Piston Shaft	6
1557AA	03170	R 1-1/8" Thread Sleeve	1
3037AV	04686	R 3-1/2", 4" & 5" Conduit Bushing	1
1924AA	03248	R Short Spacer	3
1925AA	03249	R Medium Spacer	3
1926AA	06904	R Long Spacer	3
15908	15908	R Spacer Unit	1
28154	28154	R Punch 1/2" HD Slug-Splitter®	1
28155	28155	R Die 1/2" HD Slug-Splitter	1
29451	29451	R Draw Stud, 7/16" Stainless Steel	1
31834	31834	R Cabinet A only (top)	1
31849	31849	R Cabinet B only (bottom)	1

7360SB/34358 PARTS CABINET INCLUDES

CAT. NO.	UPC NO.	DESCRIPTION	QTY.
721-1/2	31756	R Slug-Buster 1/2" Conduit Punch	18
14722	14722	R 1/2" Conduit Die	12
721-3/4	31757	R Slug-Buster 3/4" Conduit Punch	6
124AV	06972	R 3/4" Conduit Die	6
721-1	31758	R Slug-Buster 1" Conduit Punch	3
126AV	04011	R 1" Conduit Die	3
721-1-1/4	31759	R Slug-Buster 1-1/4" Conduit Punch	3
128AV	04013	R 1-1/4" Conduit Die	3
721-1-1/2	31760	R Slug-Buster 1-1/2" Conduit Punch	2
440AV	04061	R 1-1/2" Conduit Die	2
721-2	31761	R Slug-Buster 2" Conduit Punch	2
442AV	04063	R 2" Conduit Die	1
00042	00042	R 3/8" Draw Stud	12
249AVBB	04040	R 3/4" Drive Screw	4
304AVBB	04042	R 3/4" Drive Screw	4
12097	12097	R 3/8" Adapter Screw	4
12098	12098	R 3/4" Adapter Screw	2
1614SS	30043	R 3/8" Stainless Steel Adapter	20
2113AA	03294	R 3/4" Piston Shaft	4
31832	31832	R Cabinet only	1

C-FRAME PUNCHES

1731 & 1732 Portable C-Frame Punch Drivers



CAT. NO.	UPC NO.	DESCRIPTION	HOLE SIZE			KIT CAT/UPC NO.				
			SIZE	PG	Ø mm	1731/ 15911	1731H767/ 20486	1731F1725/ 25169	1732/ 27361	1732H755/ 27362
		C-Frame with Ram				✓	✓	✓	✓	✓
13266	13266	Punch Adapter - 3/8" Ø x 1/2" (9.5 mm)					✓		✓	✓
13267	13267	Punch Adapter - 3/4" Ø x 1" (19.0 mm)							✓	✓
13276	13276	Punch Adapter - 3/8" Ø x 1/2" (9.5 mm)				✓	✓	✓		
13277	13277	Punch Adapter - 3/4" Ø x 1" (19.0 mm)				✓	✓	✓		
13268	13268	Punch Adapter - 1-1/8" Ø (28.6 mm)							✓	✓
121AV	04006	1/2" Conduit Size Punch	1/2"	16	22.5	✓	✓	✓		
123AV	04008	3/4" Conduit Size Punch	3/4"	21	28.3	✓	✓	✓		
125AV	04010	1" Conduit Size Punch	1"	-	34.6	✓	✓	✓		
12087	12087	C-Frame 1/2" Conduit Size Die	1/2"	16	22.5	✓	✓	✓		
12086	12086	C-Frame 3/4" Conduit Size Die	3/4"	21	28.3	✓	✓	✓		
12085	12085	C-Frame 1" Conduit Size Die	1"	-	34.6	✓	✓	✓		
1725	25144	1725 Hydraulic Foot Pump						✓		
16634	16634	Steel Case				✓	✓	✓		
38316	38316	High Pressure Hose Unit - 1/4" x 3' (includes 1 each of the following 3 items:)					✓			
54169	54169	- 1/4" Male Coupler								
54170	54170	- Dust Cap								
06302	06302	- High Pressure Hose, 1/4" x 3'								
11791	11791	Die Adapter - 3/8" Ø (9.5 mm)							✓	✓
11790	11790	Die Adapter - 3/4" Ø (19.0 mm)							✓	✓
11789	11789	Die Adapter - 1-1/8" Ø (28.6 mm)							✓	✓
767	13284	Hydraulic Hand Pump					✓			
755	15677	Hydraulic Hand Pump								✓
37729	37729	Hydraulic Hose - 1/4" x 10' (3 m)						✓		
11289	11289	Hydraulic Hose - 3/8" x 6' (9.5 mm x 1.8)								✓
27335	27335	Metal Case							✓	✓
50642	50642	Nut - 3/4" - 10 (19.0 mm)							✓	✓
12079	12079	Frame								
15631	15631	Ram								
37614	37614	Quick Disconnect								
11903	11903	C-Frame								
13814	13814	Packing Kit								

1731 & 1732 Portable C-Frame Punch Drivers

- Fast, one-shot punching, no predrilling of pilot holes.
- Throat measures 8" (203 mm) deep.

1731

- Great for punching junction boxes and small enclosures.
- Punch can be used with ram inside or outside of the junction box.
- For use with 1/2" - 1" (22.5 mm - 34.6 mm) conduit size and accessory sizes only.

1732

- Use with 1/2" through 4" conduit size and other round sizes only.
- Use with Greenlee standard round punches and dies (optional).

SPECIFICATIONS

Capacity **1731:** Up through 10 gauge (3.0 mm) mild steel with Greenlee special C-Frame dies and standard punches; 1/2" through 1" conduit and 15.2 mm through 30.5 mm

1732: Up through 10 gauge (3.0 mm) mild steel with Greenlee Standard punches and dies; 1/2" through 4" conduit and 15.2 mm through 115.4 mm.

CAT. NO.	UPC NO.	DESCRIPTION	WEIGHT	
			LBS.	kg.
1731	15911	Driver with Ram, 1/2" Through 1" Conduit (22.5 mm through 34.6 mm) Punches and Dies	32	15
1732	27361	Driver with Ram, 3/8", 3/4" and 1-1/8" Punch and Die Adapters	59	27
1731H767	20486	Same as 1731 with 767 Hydraulic Hand Pump	36	17
1731F1725	25169	Same as 1731 with 1725 Hydraulic Foot Pump	43	20
21316	21316	Pg-9 (15.2 mm) Punch (optional)		
18557	18557	Pg-9 (15.2 mm) Die (optional)		
17700	17700	Pg-11 (18.6 mm) Punch (optional)		
18558	18558	Pg-11 (18.6 mm) Die (optional)		
17697	17697	Pg-13 (20.4 mm) Punch (optional)		
18559	18559	Pg-13 (20.4 mm) Die (optional)		
36282	36282	1-7/32" (30.5 mm) Oil Tight Punch (optional)		
37103	37103	1-7/32" (30.5 mm) Oil Tight Die (optional)		

SPECIAL APPLICATION PUNCHES

Oiltight Punches with Notches

Other oiltight sizes without notches available in standard, Slug-Buster® and Slug-Splitter® designs.

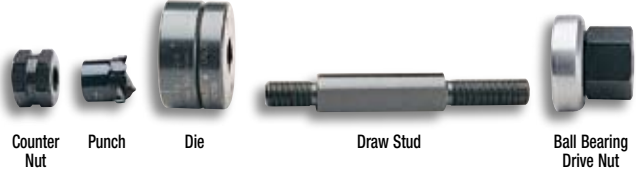
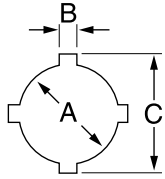

HOLE SIZE						MAXIMUM CAPACITY MILD STEEL	OPERATION TYPE	CAT./UPC NO.					MINIMUM PILOT HOLE		WEIGHT LBS. kg.	OPTIONAL ADAPTER FOR HYDRAULIC DRIVERS			
INCH			mm					GA	mm	PUNCH UNIT (INCLUDES PUNCH, DIE, DRAW STUD AND NUTS)		DRAW STUD	BB DRIVE NUT	COUNTER NUT			INCH	mm	
A	B	C	A	B	C	PUNCH	DIE			MINIMUM	WEIGHT								
.875	.125	1.000	22.5	3.2	25.4	14	2.0	Hand/Hydr.	60238	60239	60250	60117	60165	60258	.625	15.9	2.1	.95	60167◇
1.210	.190	1.380	30.5	4.8	36.0	10	3.5	Hand/Hydr.	60242	60243	60249	60117	60165	60258	.625	15.9	2.7	1.2	60167◇

For maximum draw stud life, Greenlee recommends the use of battery or hydraulic drivers.

Key Punches

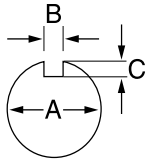

HOLE SIZE						MAXIMUM CAPACITY MILD STEEL	OPERATION TYPE	CAT./UPC NO.					MINIMUM PILOT HOLE		WEIGHT LBS. kg.	OPTIONAL ADAPTER FOR HYDRAULIC DRIVERS			
INCH			mm					GA	mm	PUNCH UNIT (INCLUDES PUNCH, DIE, DRAW STUD AND NUTS)		DRAW STUD	BB DRIVE NUT	COUNTER NUT			INCH	mm	
A	B	C	A	B	C	PUNCH	DIE			MINIMUM	WEIGHT								
0.481	0.055	.030	12.2	1.4	.8	16	1.5	Hand/Hydr.	60101	60102	60103	60115	60120	05244	.375	9.5	.88	.4	60114◇
1.171	0.123	.097	29.7	3.1	2.5	14	2.0	Hand/Hydr.	60104	60105	60106	60166	60165	60258	.875	23.8	2.3	1.0	60167◇
1.265	0.156	.097	32.1	4.0	2.5	14	2.0	Hand/Hydr.	60107	60108	60109	60166	60165	60258	.875	23.8	2.4	1.1	60167◇
1.328	0.102	.097	33.7	2.6	2.5	14	2.0	Hand/Hydr.	60110	60111	60112	60166	60165	60258	.875	23.8	2.4	1.1	60167◇

For use with any Greenlee Hydraulic Driver or Battery-Powered Driver. For maximum draw stud life, Greenlee recommends the use of battery or hydraulic drivers

720 Keyway Punch

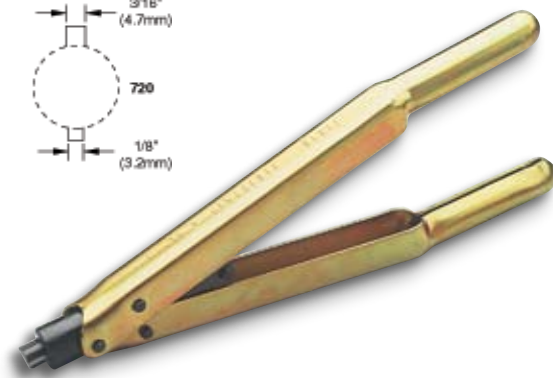
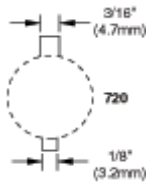

- Eliminates time-consuming hand sawing and filing when making keyways for push-button switches.
- Use as a nibbler to make wider or deeper keyways.
- Punches 1/8" (3.2 mm) or 3/16" (4.8 mm) keyways for 7/8" (22.5 mm) or 1-7/32" (30.5 mm) push-button holes.
- U.S. Patent No. 4,375,128; Canadian Patent No. 1,172,435.

CAT. NO.	UPC NO.	DESCRIPTION	WEIGHT LBS. kg.
720	26534	Keyway Punch	2.8 1.27
	26536	Punch	
	26538	Die	

SPECIFICATIONS

Operation Manual
Capacity 10 gauge (3.5 mm) mild steel

NOTE: Not for Stainless Steel

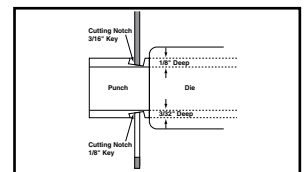
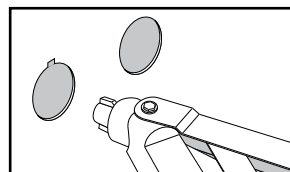
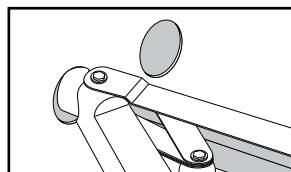
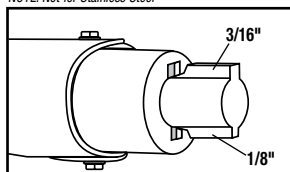

1. Locate proper cutting notch on the cutting head.
2. Place cutting notch inside edge of hole and cut keyway.
3. Withdraw the punch.
4. Use as a nibbler to make wider or deeper keyways.

R = REPLACEMENT PART A = ACCESSORY

"D" Punches

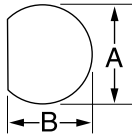

HOLE SIZE				MAXIMUM CAPACITY MILD STEEL		OPERATION TYPE	CAT./UPC NO.					MINIMUM PILOT HOLE		WEIGHT		OPTIONAL ADAPTER FOR HYDRAULIC DRIVERS	
INCH		mm		GA	mm		PUNCH UNIT (INCLUDES PUNCH, DIE, DRAW STUD AND NUTS)	PUNCH	DIE	DRAW STUD	BB DRIVE NUT	COUNTER NUT	INCH	mm	LBS.		kg.
A	B	A	B														
0.500	0.469	12.7	11.9	16	2.0	Hand/Hydr.	60077	60078	60079	60115	60120	05244	.375	9.5	.9	.41	60114◇
0.625	0.594	15.9	15.1	14	2.0	Hand/Hydr.	61080**			34421	34733	04638	.500	12.7	1.1	.50	33967◇
0.750	0.703	19.1	17.9	14	2.0	Hand/Hydr.	61083**			34421	34733	04638	.500	12.7	1.2	.50	33967◇

◇ For use with any Greenlee Hydraulic Driver or Battery-Powered Driver

For maximum draw stud life, Greenlee recommends the use of battery or hydraulic drivers

** Sold as Unit only

Double "D" Punches

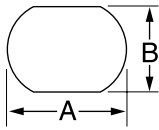

HOLE SIZE				MAXIMUM CAPACITY MILD STEEL		OPERATION TYPE	CAT./UPC NO.				MINIMUM PILOT HOLE		WEIGHT		OPTIONAL ADAPTER FOR HYDRAULIC DRIVERS
INCH		mm		GA	mm		PUNCH UNIT (INCLUDES PUNCH, DIE, DRAW STUD AND NUTS)	DRAW STUD	BB DRIVE NUT	COUNTER NUT	INCH	mm	LBS.	kg.	
A	B	A	B												
0.769	0.642	19.5	16.3	14	2.0	Hand/Hydr.	61086**	34421	34733	04638	.500	12.7	1.1	.50	33967◇
0.795	0.697	20.2	17.6	14	2.0	Hand/Hydr.	61089**	34421	34733	04638	.500	12.7	1.1	.50	33967◇
0.913	0.756	23.2	19.2	14	2.0	Hand/Hydr.	61092**	34421	34733	04638	.500	12.7	1.2	.54	33967◇
0.913	0.795	23.2	20.2	14	2.0	Hand/Hydr.	61095**	34421	34733	04638	.500	12.7	2	.9	33967◇
1.375	1.125	34.9	28.6	14	2.0	Hand/Hydr.	60098**	60166	60165	60258	.875	23.8	2.5	1.1	60167◇

◇ For use with any Greenlee Hydraulic Driver or Battery-Powered Driver

For maximum draw stud life, Greenlee recommends the use of battery or hydraulic drivers

** Sold as Unit only

Square and Special Square Punches

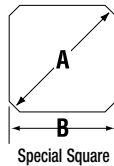

HOLE SIZE				MAXIMUM CAPACITY MILD STEEL		OPERATION TYPE	CAT./UPC NO.					MINIMUM PILOT HOLE		WEIGHT		OPTIONAL ADAPTER FOR HYDRAULIC DRIVERS
INCH		mm		GA	mm		PUNCH UNIT (INCLUDES PUNCH, DIE, DRAW STUD AND NUTS)	PUNCH	DIE	DRAW STUD	BB DRIVE NUT	COUNTER NUT	INCH	mm	LBS.	
1/2"	0.500 x 0.500	12.7 x 12.7	16	1.5	◇Hand/Hydr.	60001	60002	60003	60115	60120	05244	.375	9.5	1.1	.50	60114◇
5/8"	0.625 x 0.625	15.9 x 15.9	14	2.0	◇Hand/Hydr.	61004	60005	60006	34421	34733	04638	.500	12.7	1.5	.68	33967◇
3/4"	0.750 x 0.750	19.1 x 19.1	14	2.0	◇Hand/Hydr.	61007	60008	60009	34421	34733	04638	.500	12.7	1.5	.68	33967◇
7/8"	0.882 x 0.882	22.4 x 22.4	14	2.0	◇Hand/Hydr.	61010	60011	60012	34421	34733	04638	.500	12.7	1.8	.82	33967◇
	0.945 x 0.945	24.0 x 24.0	14	2.0	◇Hand/Hydr.	61013	60014	60015	34421	34733	04638	.500	12.7	2.3	1.0	33967◇
1"	1.000 x 1.000	25.4 x 25.4	14	2.0	◇Hand/Hydr.	60016	60017	60018	60117	60165	60258	.625	15.9	2.4	1.1	60167◇
	1.772 x 1.772	45.0 x 45.0	10	3.5	◇Hydr. Only	60287	60288	60289	60118	—	60235	1.188	30.2	6.0	2.7	◇
1-13/16"	1.811 x 1.811	46.0 x 46.0	10	3.5	◇Hydr. Only	60019	60020	60021	60118	—	60235	1.188	30.2	6.2	2.8	◇
2"	2.000 x 2.000	50.8 x 50.8	10	3.5	◇Hydr. Only	60168	60169	60170	60118	—	60235	1.188	30.2	6.9	3.1	◇
2-11/16"	2.677 x 2.677	68.0 x 68.0	10	3.5	◇Hydr. Only	60171	60172	60173	60118	—	60235	1.188	30.2	10.1	4.6	◇
3-5/8"	3.622 x 3.622	92.0 x 92.0	10	3.5	*Hydr. Only	60174	60175	60176	60118	—	60235	1.188	30.2	14.8	6.7	*
4-1/8"	4.125 x 4.125	104.8 x 104.8	10	3.5	*Hydr. Only	60177	60178	60179	60118	—	60235	1.188	30.2	18.8	8.5	*
	5.433 x 5.433	138.0 x 138.0	14	2.0	*Hydr. Only	60234	60023	60024	60118	—	60235	1.188	30.2	20	9.1	*

SPECIAL SQUARE

0.886(A)	0.791(B)	22.5 Ø(A) 20.1(B)	14	2.0	Hand/Hydr.	61125**			34421	34733	04638	.500	12.7	.7	.3	33967
----------	----------	-------------------	----	-----	------------	---------	--	--	-------	-------	-------	------	------	----	----	-------

* For use with Hand and Foot Pump Hydraulic Drivers with Ram

◇ For use with any Greenlee Hydraulic Driver or Battery-Powered Driver

B = REPLACEMENT PART **A** = ACCESSORY

For maximum draw stud life, Greenlee recommends the use of battery or hydraulic drivers

** Sold as Unit only

Rectangular Punches



HOLE SIZE		MAXIMUM CAPACITY MILD STEEL		OPERATION TYPE	CAT./UPC NO.						MINIMUM PILOT HOLE Ø		WEIGHT		OPTIONAL ADAPTER FOR HYDRAULIC DRIVERS
					PUNCH UNIT (INCLUDES PUNCH, DIE, DRAW STUDS AND NUTS)	PUNCH	DIE	DRAW STUD	BB DRIVE NUT	COUNTER NUT					
INCH	mm	GA	mm												
0.437 x 0.875	11.1 x 22.2	16	1.5	Hand/Hydr.	60025	60026	60027	60115	60120	05244	.375	9.5	1.2	.5	60114
0.670 x 0.749	17.0 x 19.0	14	2.0	Hand/Hydr.	61028	60029	60030	34421	34733	04638	.500	12.7	1.5	.68	33967
0.750 x 1.140	19.1 x 29.0	14	2.0	Hand/Hydr.	60031	60032	60033	60117	60165	60258	.625	15.9	2.3	1.0	60167
0.750 x 1.310	19.1 x 33.3	14	2.0	Hand/Hydr.	60034	60035	60036	60117	60165	60258	.625	15.9	2.3	1.0	60167
0.861 x 1.018	21.9 x 25.9	14	2.0	Hand/Hydr.	60037	60038	60039	60117	60165	60258	.625	15.9	2.3	1.0	60167
0.866 x 1.181	22.0 x 30.0	14	2.0	Hand/Hydr.	60040	60041	60042	60117	60165	60258	.625	15.9	2.4	1.1	60167
0.866 x 1.654	22.0 x 42.0	14	2.0	Hand/Hydr.	60043	60045	60046	60117	60165	60258	.625	15.9	2.9	1.3	60167
0.990 x 1.140	25.1 x 29.0	14	2.0	Hand/Hydr.	60047	60048	60049	60117	60165	60258	.625	15.9	2.6	1.2	60167
1.250 x 1.380	31.8 x 35.1	14	2.0	Hand/Hydr.	60050	60051	60052	60117	60165	60258	.625	15.9	3.1	1.4	60167
1.312 x 2.625	33.3 x 66.7	10	3.5	Hydr. Only	60053	60054	60055	60118	—	60235	1.188	30.2	5.1	2.3	Ø
1.378 x 2.047	35.0 x 52.0	10	3.5	Hydr. Only	60056	60057	60058	60118	—	60235	1.188	30.2	6.1	2.8	Ø
1.378 x 2.559	35.0 x 65.0	10	3.5	Hydr. Only	60059	60060	60061	60118	—	60235	1.188	30.2	6.8	3.1	Ø
1.378 x 3.228	35.0 x 82.0	14	2.0	*Hydr. Only	60062	60063	60064	60118	—	60235	1.188	30.2	7.7	3.5	*
1.378 x 4.409	35.0 x 112.0	14	2.0	*Hydr. Only	60065	60066	60067	60118	—	60235	1.188	30.2	9.2	4.2	*
1.811 x 3.622	46.0 x 92.0	10	3.5	*Hydr. Only	60068	60069	60070	60118	—	60235	1.188	30.2	8.9	4.0	*
2.250 x 3.500	57.2 x 88.9	10	3.5	*Hydr. Only	60071	60072	60073	60118	—	60235	1.188	30.2	10.1	4.6	*
2.677 x 5.433	68.0 x 138.0	14	2.0	*Hydr. Only	60074	60075	60076	60118	—	60235	1.188	30.2	16.1	7.3	*

*For use with with Hand and Foot Pump Hydraulic Drivers with Ram
 ØFor use with any Greenlee Hydraulic Driver or Battery-Powered Driver

For maximum draw stud life, Greenlee recommends the use of battery or hydraulic drivers

Electronic Connector Panel Punches



- Cut-out and mounting slots are punched in one operation.
- Drill only one 7/16" (11.1 mm) pilot hole. (See page 70 for Kwik Stepper® step bits.)
- Fast, accurate panel punching with no sawing or filing required.
- Universal size punches for front or back mount of TRW Cinch and ITT Cannon-type or equivalent connectors in 9, 15, 25, 37 or 50-pin configurations.
- U.S. Patent No. 4,899,447

SPECIFICATIONS

Capacity	16 gauge (1.5 mm) mild steel; 10 gauge (3.5 mm) aluminum
Operation	Manual with a wrench; Quick Draw® and Quick Draw 90® hydraulic drivers, Battery Driver, Ram and Pump hydraulic drivers aluminum

PUNCH UNIT		NO. OF PINS	DIMENSIONS			REPLACEMENT CAT./UPC NO.					WEIGHT	
CAT. NO.	UPC NO.		A	B	C	PUNCH	DIE UNIT	DRAW STUD	SQUARE COUNTER NUT	DRIVE NUT	LBS.	kg.
229	34436	9	.787" (20.0 mm)	.982" (24.9 mm)	.469" (11.9 mm)	34441	35196	34421	04638	34733	1.4	.64
231	34437	15	1.127" (28.6 mm)	1.309" (33.3 mm)	.469" (11.9 mm)	34442	35197	34421	04638	34733	1.5	.68
RS232	34420	25	1.655" (42.0 mm)	1.853" (47.1 mm)	.469" (11.9 mm)	34418	35198	34421	04638	34733	2.0	.91
234	34429	37	2.296" (58.3 mm)	2.497" (63.4 mm)	.469" (11.9 mm)	34427	35199	34421	04638	34733	2.0	.91
238	34444	50	2.201" (55.9 mm)	2.402" (61.0 mm)	.579" (14.7 mm)	34443	35200	34421	04638	34733	2.0	.91

For maximum draw stud life, Greenlee recommends the use of battery or hydraulic drivers

R = REPLACEMENT PART A = ACCESSORY

DRAW STUDS FOR KNOCKOUTS

Replacement Draw Studs for Manual Drivers

Replacement Draw Stud Selection Guide

Refer to the **ACTUAL SIZE PICTURES** and information below when ordering a replacement draw stud. Sizes given are diameter X length.



3026AV –
1-1/8" (28.6 mm) x 7-1/2" (190 mm)

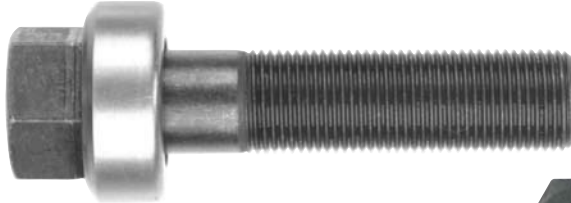

304AVBB – 3/4" (19.0 mm) x 2-15/16" (75 mm)



00042 – 3/8" (9.5 mm) x 1-5/8" (41 mm)

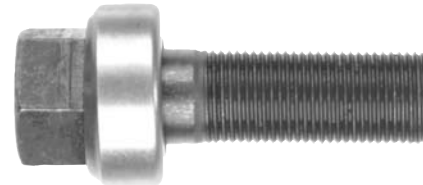

249AVBB – 3/4" (19.0 mm) x 2-1/8" (54 mm)



1675AV Draw Stud – 1/4" (6.4 mm) x 1-3/8" (35 mm)

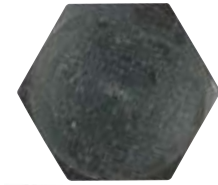

1434AV
3/4" (19.0 mm) x
5-1/2" (140 mm)

Replacement Draw Studs for Hydraulic Drivers

Replacement Draw Stud Selection Guide

Refer to the **ACTUAL SIZE PICTURES** and information below when ordering a replacement draw stud. Sizes given are diameter X length.



1557AA- 1-1/8" (28.6 mm) x 3" (76 mm)



1614SS- 3/8" (9.5 mm) x 2-13/16" (71 mm)



60114 (Adapter) - 3/4" (19 mm) x 1/4" (6.35 mm) internal



60167 (Adapter) - 3/4" (19 mm) x 1/2" (12.7 mm) internal



33967 (Adapter) - 3/4" (19 mm) x 3/8" (9.5 mm) internal



31872 - 3/4" (19 mm) x 4-1/2" (114.3 mm)



29451 - 7/16" (11.1 mm) x 4-1/4" (108 mm)



2113AA - 3/4" (19.0 mm) x 5-3/8" (137 mm)



29452 - 3/4" (19.0 mm) x 5-1/2" (140 mm)

International Tel: +1.815.397.7070
Fax: +1.815.397.9247

Canada Tel: 800.435.0786
Fax: 800.524.2853

USA Tel: 800.435.0786
Fax: 800.451.2632

Replacement Draw Studs for Ratchet Drivers

Replacement Draw Stud Selection Guide

Refer to the **ACTUAL SIZE PICTURES** and information below when ordering a replacement draw stud. Sizes given are diameter X length.



12099 – 3/4" (19.0 mm) x 4-3/4" (121 mm)



30227 – 7/16" (11.1 mm) x 3-5/8" (92 mm)



12097 – 3/8" (9.5 mm) x 3-1/2" (89 mm)

Replacement Draw Studs for Special Shape Punches

Replacement Draw Stud Selection Guide

Refer to the **ACTUAL SIZE PICTURES** and information below when ordering a replacement draw stud. Sizes given are diameter X length.

For maximum draw stud life, Greenlee recommends the use of battery or hydraulic drivers.



60166 - 1/2" (12.7 mm) x 4-5/8" (117.5 mm)



60117 - 1/2" (12.7 mm) x 4-5/8" (117.5 mm)



34421 - 3/8" (9.5 mm) x 3-1/2" (88.9 mm)



60115 - 1/4" (6.3 mm) x 3-7/16" (87.3 mm)



60116 - 1/2" (12.7 mm) x 4-5/8" (117.5 mm)

60118 - 3/4" (19 mm)
x 6-3/4" (171.5 mm)

STUD PUNCHES

Structural Stud Punch



- Punch 16 and 18 gauge structural studs in **5 seconds**.
- Punch **200 holes** per battery charge, 2 batteries & charger included, eliminating downtime.
- Punches a 1.34 (34.1 mm) diameter hole in 16 (1.5 mm) gauge steel. For use with Greenlee 712A bushings.
- Swivel head rotates 360° for use in tight corners.
- Pistol grip handle gives better leverage and reduces fatigue.
- Replacement punch and die.
- Lightweight 9.2 lb. tool provides heavy-duty performance.

BATTERY-POWERED STUD PUNCH

CAT. NO.	UPC NO.	ACTUAL HOLE SIZE		WEIGHT		LENGTH		HEIGHT		CAPACITY		BATTERY	CHARGER
		IN.	mm	LBS.	kg	IN.	mm	IN.	mm	GA	mm		
ESP710-11	10307	1-11/32	34.1	9.2	4.2	15	381	11-3/4	298	16	1.5	12V2.0 Ah NiCd	120 Volt
ESP710-12	10308	1-11/32	34.1	9.2	4.2	15	381	11-3/4	298	16	1.5	12V2.0 Ah NiCd	12 Volt
ESP710-22	10309	1-11/32	34.1	9.2	4.2	15	381	11-3/4	298	16	1.5	12V2.0 Ah NiCd	230 Volt

CAT. NO.	UPC NO.	DESCRIPTION
12274	12274	Carrying Strap
02999	02999	12V NiCd battery
MKESP710GL	10303	Carrying Case
03046	03046	120V Charger
03048	03048	12V Charger
03047	03047	230V Charger

Plumber Stud Punch



- Punches 2-5/8" (66.7 mm) diameter hole in metal studs for professional-looking installation of 2" water, vent, waste pipes.
- Two-speed lever action for fast, easy punching of 24 to 20 gauge thick metal studs.
- 2-1/8" (54 mm) throat width fits over most studs and channels.
- High strength alloy aluminum c-frame and handle provides lightweight tool for easy handling—10.6 lb. (4.8 kg).
- Lever action punch retraction strips punch out of metal stud fast and easy. Patent #6,647,630

PLUMBER STUD PUNCH

CAT. NO.	UPC NO.	ACTUAL HOLE SIZE		WEIGHT		LENGTH		HEIGHT		CAPACITY	
		IN.	mm	LBS.	kg	IN.	mm	IN.	mm	GA	mm
713	06430	2-5/8	66.7	10.6	4.8	23-1/2	596	9-3/4	247	24-20	0.9

CAT. NO.	UPC NO.	DESCRIPTION
08377	08377	Punch for 713
08379	08379	Die for 713

= REPLACEMENT PART = ACCESSORY

Metal Stud Punches



- Punch up through 20 gauge (0.9 mm) steel studs in one stroke.
- Aluminum head provides strength with minimum weight, reducing operator fatigue.
- Contoured handle design gives better operator leverage and makes it possible to punch in tight places.
- Self-stripping design eliminates punch hang-ups.
- Automatically centers holes on standard studs.
- Conversion kit available to upgrade early models from 24 gauge to 20 gauge maximum capacity.

SPECIFICATIONS

Capacity	709 - 1-5/8" (41.3 mm) and wider studs.
	20 gauge (0.9 mm) steel studs.
	710 - 2-1/2" (63.4 mm) and wider studs.
	20 gauge (0.9 mm) steel studs.

CAT. NO.	UPC NO.	DESCRIPTION	WEIGHT	
			LBS.	kg
709	22280	7/8" (22.2 mm) Diameter Stud Punch	7	3.2
710	21285	1-11/32" (34.1 mm) Diameter Stud Punch	7.5	3.5
30968	30968	Conversion Kit – Upgrades Early Model 709 or 710 from 24 to 20 Gauge Maximum Capacity		
121AV	04006	R Punch for 709		
22286	22286	R Die for 709		
24823	24823	R Punch for 710		
21297	21297	R Die for 710		
06015	06015	Repair Kit		
36617	36617	Link		

Bushings for Metal Stud Punches

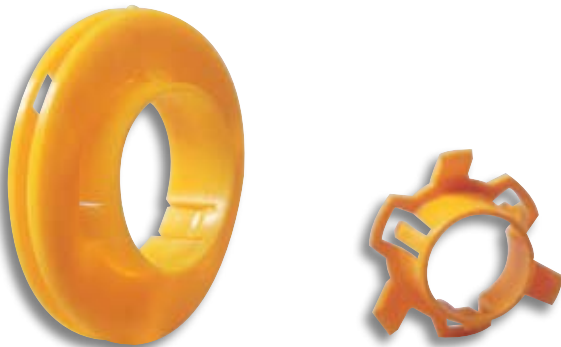

- Triple lock design holds bushing securely.
- Locks securely into metal studs from 24 gauge to 12 gauge (0.6 mm to 2.5 mm).
- Helps protect wire insulation from sharp edges of metal studs.
- Makes pulling smooth and easy by preventing hang-ups of cable on raw metal edges.

CAT. NO.	UPC NO.	DESCRIPTION	WEIGHT	
			LBS.	kg
711C	22288	100 Bushings for Hole Punched by 709 for 7/8" (22.2 mm) Diameter Hole	.5	.23
711M	22289	1,000 Bushings for Hole Punched by 709 for 7/8" (22.2 mm) Diameter Hole	3.7	1.7
712A100	05927	100 Bushings for Pre-Punched Hole or 1-11/32" (34.1 mm) Diameter Hole Punched by 710	1.4	.64
712A1000	05928	1,000 Bushings for Pre-Punched Hole or 1-11/32" (34.1 mm) Diameter Hole Punched by 710	15.5	7.0

Manual Stud Punch



- Punch up through 20 gauge (0.9 mm) steel studs in one stroke.
- Unique patented punch rolls the edge over for smooth installation of armored cable; cable won't hang up.
- Contoured handle design gives better operator leverage and makes it possible to punch in tight places.
- Automatically centers holes on standard studs.

MANUAL STUD PUNCH

CAT. NO.	UPC NO.	ACTUAL HOLE SIZE		WEIGHT		LENGTH		HEIGHT		CAPACITY	
		IN.	mm	LBS.	kg	IN.	mm	IN.	mm	GA	mm
724	10415	1-1/4	31.7	4.0	1.8	16-3/4	426	4-1/2	114	24-20	0.9

CAT. NO.	UPC NO.	DESCRIPTION
10419	10419	R Punch for 724

DRILL/TAPS

Combination Drill/Tap Bits



NEW



DTAPKITM

- Complete hole drilling, tapping and deburring/countersinking in one operation with power drill saves labor and time.
- Back tapered beyond tap to prevent thread damage from over-drilling.
- Deburr/countersink also provided on bit beyond back taper.
- Made from hardened high-speed steel vs. carbon steel for longer life.
- High quality hex shank to ensure strong connection to drill chuck.
- Designed to tap up to 10-gauge metal.
- Quick change adaptor included in both metric and standard kits.

CAT. NO.	UPC NO.	DESCRIPTION	DTAPKIT	DTAPKITM
DTAPKITM	12151	M3-M10 6 Piece Drill/Tap Set		
DTAPKIT	17620	6-32 to 1/4-20 6-piece Drill Tap Set		
DTAP6-32	17611	R 6-32NC Drill/Tap Bit	X	
DTAP8-32	17612	R 8-32NC Drill/Tap Bit	X	
DTAP10-24	17613	R 10-24NC Drill/Tap Bit	X	
DTAP10-32	17614	R 10-32NF Drill/Tap Bit	X	
DTAP12-24	17615	R 12-24NC Drill/Tap Bit	X	
DTAP1/4-20	17616	R 1/4-20NC Drill/Tap Bit	X	
DTAP5/16-18	11627	5/16-18NC Drill/Tap Bit		
DTAP3/8-16	11628	3/8-16NC Drill/Tap Bit		
DTAPM3C	12160	R M3 X .50 Drill/Tap Bit		X
DTAPM4C	12161	R M4 X .70 Drill/Tap Bit		X
DTAPM5C	12162	R M5 X .80 Drill/Tap Bit		X
DTAPM6C	12163	R M6 X 1.00 Drill/Tap Bit		X
DTAPM8C	12164	R M8 X 1.25 Drill/Tap Bit		X
DTAPM10C	12165	R M10 X 1.50 Drill/Tap Bit		X

SPECIFICATIONS

Material thickness	Up to 10 gauge
Material type	Mild steel, copper, brass, aluminum
Shank	1/4" quick change hex
Drill Material	High-speed steel
Drill point	Split point with web thinning



NOTE: TO EXTEND THE LIFE OF YOUR TOOL, SEE CUTTING/THREADING OIL ON PAGE 376.

STEP BITS

Kwik Stepper® Step Bits



- Unique split-tip design penetrates through steel faster.
- Resists walking or skidding, even on round surfaces.
- Balanced, double-flute construction requires less pressure, does the work for you.
- Designed and manufactured in USA.

CAT. NO.	UPC NO.	DESCRIPTION
35884	35884	Kwik Stepper Step Bit Kit
03607	03607	Kwik Stepper Step Bit Kit

SPECIFICATIONS	
Hole Sizes	From 1/8" through 1-3/8" (3.2 - 34.9 mm)
Capacity	Cut up through 3/8" (9.5 mm) mild steel, copper, brass, aluminum, wood, plastic and laminates

CAT. NO.	UPC NO.	DESCRIPTION	03607	35884
34401	34401	1/2" Multi-Hole Step Bit	•	•
34403	34403	7/8" Multi-Hole Step Bit	•	•
30008	30008	1-1/8" Multi-Hole Step Bit	•	•
35936	35936	Plastic Case	•	•

Single-hole bits are designed to drill one indicated hole size through a series of steps from bit tip to full size.

Multi-hole bits allow you to drill a hole in any of the stated diameters.

									METRIC		
	1/2" (12.7 mm) Single-Hole Step Bit	1/2" (12.7 mm) Multi-Hole Step Bit	1/2" (12.7 mm) Multi-Hole Step Bit	13/16" (20.6 mm) Multi-Hole Step Bit	7/8" (22.2 mm) Single-Hole Step Bit	7/8" (22.2 mm) Multi-Hole Step Bit	1-1/8" Electrician's Step Bit	1-1/8" (34.9 mm) Multi-Hole Step Bit	9.7 mm (.382") Multi-Hole Step Bit	30.5 mm (1.201") Multi-Hole Step Bit	32.5 mm (1.280")

SIZE		CAT./UPC NO.										
INCHES	mm	34410	34401	36402	30005	34411	34403	30008	36414	36018	36020	36022
1/8	3.2		✓									
5/32"	4.0		✓									
3/16"	4.8		✓	✓	✓		✓					
7/32"	5.6		✓									
1/4"	6.4		✓	✓	✓		✓					
9/32"	7.1		✓									
5/16"	7.9		✓	✓	✓		✓					
11/32"	8.7		✓									
3/8"	9.5		✓	✓	✓		✓					
0.382"	9.7										✓	
13/32"	10.3		✓									
7/16"	11.1		✓	✓	✓		✓					
15/32"	11.9		✓									
0.492"	12.5										✓ Pg-7	
1/2"	12.7	✓	✓	✓	✓		✓	✓				
9/16"	14.3				✓		✓					
0.598"	15.2										✓ Pg-9	
5/8"	15.9				✓		✓					
0.638"	16.2											✓ ISO-16
11/16"	17.5				✓		✓					
0.732"	18.6										✓ Pg-11	
3/4"	19.1				✓		✓					
0.803"	20.4										✓ Pg-13	✓ ISO-20
13/16"	20.6				✓		✓					
7/8"	22.2					✓	✓	✓	✓			
0.886"	22.5										✓ Pg-16	
1.00"	25.4											✓ ISO-25
1.114"	28.3										✓ Pg-21	
1-1/8"	28.6							✓	✓			
1.201"	30.5								✓			
1-7/32"	31.0								✓			
1-1/4"	31.8								✓			
1.280"	32.5											✓ ISO-32
1-3/8"	34.9								✓			
Overall Length		1-7/8" (47.6 mm)	3-3/8" (85.7 mm)	3-7/16" (87.3 mm)	3-7/16" (87.3 mm)	2-7/16" (61.9 mm)	3-9/16" (90.5 mm)	2-15/16" (74.6 mm)	3-1/8" (79.4 mm)	1-7/8" (47.6 mm)	3-3/4" (95.3 mm)	3-3/8" (85.7 mm)
Minimum		3/8"	3/8"	3/8"	3/8"	3/8"	3/8"	3/8"	3/8"	3/8"	3/8"	3/8"
Chuck Size		(9.5 mm)	(9.5 mm)	(9.5 mm)	(9.5 mm)	(9.5 mm)	(9.5 mm)	(9.5 mm)	(9.5 mm)	(9.5 mm)	(9.5 mm)	(9.5 mm)
Maximum Material Thickness		10 gauge (3.5 mm)	10 gauge (3.5 mm)	3/8" (9.5 mm)	10 gauge (3.5 mm)	10 gauge (3.5 mm)	10 gauge (3.5 mm)	10 gauge (3.5 mm)	10 gauge (3.5 mm)	10 gauge (3.5 mm)	1/4" (6.4 mm)	1/4" (6.4 mm)
Bit Extension		901	901	901	901	—	—	—	—	901	—	—

AUGER BITS

Nail Eater II® Wood Boring Bits



- Patented new design for improved cutting and cleaner holes.
- Self-feeding screw point draws bit through wood.
- Unique patented design cutting angle - smoother starts, reduced cutting loads.
- Made of super tough, heat-treated steel; cuts through nails and provides longer life.
- "Shorty" bits - for working in tight places, yet still can go through three abutting 2 x 4s.
- See "Bit Extensions" if more length is required (see page 72).
- P.O.P packaged

SPECIFICATIONS

61 PTS SHORTY NAIL EATER II, 62 PTS AND 61/62 BIG SHANK SHORTY NAIL EATER II BITS	
Overall Length	7-5/8" (193.7 mm)
Twist Length	5" (127 mm)
Electric drill required	61 PTS - 5/8 through 61 PTS - 1, minimum 3/8" drill; All Big Shank, 1/2" drill.
66 PT NAIL EATER II BITS	
Overall Length	18" (457.2 mm)
Twist Length	15" (381 mm)

61PTS SHORTY, 62PTS AND 61/62 PTS BIG SHANK SHORTY NAIL EATER II BITS

CAT. NO.	POP UPC NO.	BULK UPC NO.	HOLE DIA.		HEX SHANK		WEIGHT	
			INCH	mm	INCH	mm	LBS.	g
61PTS-5/8	30419	—	5/8	15.9	5/16	7.9	.3	137
61PTS-3/4	30423	—	3/4	19.1	5/16	7.9	.4	182
61PTS-7/8	30427	—	7/8	22.2	5/16	7.9	.5	227
61PTS-1	30429	—	1	25.4	5/16	7.9	.8	363
62PTS-5/8	31788	—	5/8	15.9	7/16	11.1	.3	137
62PTS-11/16	31790	—	11/16	17.5	7/16	11.1	.4	182
62PTS-3/4	31792	36640	3/4	19.1	7/16	11.1	.5	227
62PTS-13/16	31794	—	13/16	20.6	7/16	11.1	.5	227
62PTS-7/8	31796	36642	7/8	22.2	7/16	11.1	.6	273
62PTS-1	31798	36643	1	25.4	7/16	11.1	.7	318
61/62PTS-1-1/8	30431	—	1-1/8	28.6	7/16	11.1	.9	409
61/62PTS-1-1/4	30433	—	1-1/4	31.8	7/16	11.1	1.1	499

66PT NAIL EATER II BITS

CAT. NO.	POP UPC NO.	BULK UPC NO.	HOLE DIA.		HEX SHANK		WEIGHT	
			INCH	mm	INCH	mm	LBS.	g
66PT-1/2	30915	—	1/2	12.7	5/16	7.9	.7	318
66PT-5/8	30919	—	5/8	15.9	7/16	11.1	.8	363
66PT-11/16	30921	—	11/16	17.5	7/16	11.1	1	454
66PT-3/4	30923	36659	3/4	19.1	7/16	11.1	1.2	545
66PT-13/16	30925	—	13/16	20.6	7/16	11.1	1.2	545
66PT-7/8	30927	36662	7/8	22.2	7/16	11.1	1.5	681
66PT-15/16	30929	—	15/16	23.8	7/16	11.1	1.6	726
66PT-1	30931	36664	1	25.4	7/16	11.1	1.8	817
66PT-1-1/8	30935	—	1-1/8	28.6	7/16	11.1	2.3	1044
66PT-1-1/4	30937	—	1-1/4	31.8	7/16	11.1	2.8	1270

Nail Eater II® Impact Bits



- Quickly bore through creosoted and salt-treated utility poles.
- Resists wear, eats through nails and staples.
- Self-feeding screw point draws the bit through the wood.
- 7/16" hex shank to fit impact drivers.
- Available in 18" overall length.

CAT. NO.	UPC NO.	HARDWARE DIA.		HOLE DIA.		OVERALL LENGTH		HEX SHANK		WEIGHT	
		INCH	mm	INCH	mm	INCH	mm	INCH	mm	LBS.	g
37868	37868	9/16	14.3	5/8	15.9	18	457.2	7/16	11.1	0.9	409
37869	37869	11/16	17.5	3/4	19.1	18	457.2	7/16	11.1	1.1	499
37870	37870	13/16	20.6	7/8	22.2	18	457.2	7/16	11.1	1.4	636
37871	37871	15/16	23.8	1	25.4	18	457.2	7/16	11.1	1.5	681

Bit Extensions



- Extend bit lengths - Holesaw arbors, spade bits, Nail Eater II® bits, Electrician's bits and Step bits.
- Use for boring deeper in wood.

CAT. NO.	UPC NO.	DESCRIPTION
3713GB	50962	R Set Screw for 901-12/02706
3678GB	50753	R Set Screw for 902-18/02707 and 902-24/02708
3693GB	50765	R Set Screw for 904-5-1/2/34996
53892	53892	R Set Screw for 904H-12/34980, 904H-18/35356 and 904H-24/35358
51376	51376	R Allen Wrench for use with Set Screws for 901-12/02706, 902-18/02707 and 902-24/02708
52144	52144	R Allen Wrench for use with Set Screws for 904-5-1/2/34996

CAT. NO.	UPC NO.	LENGTH		HEX SHANK		HOLE DIA.		HEAD DIA.		WEIGHT	
		INCH	mm	INCH	mm	INCH	mm	INCH	mm	LBS.	g
901-12	02706	12	304.8	1/4	6.4	1/4	6.4	9/16	14.3	1.4	636
902-18	02707	18	457.2	5/16	7.9	23/64	9.1	21/32	16.7	2.5	1134
902-24	02708	24	609.6	5/16	7.9	23/64	9.1	21/32	16.7	3.4	1543
904-5-1/2	34996	5-1/2	139.7	7/16	11.1	1/2	12.7	1	25.4	2.1	953
904H-12	34980	12	304.8	7/16	11.1	**		23/32	18.3	2.9	1316
904H-18	35356	18	457.2	7/16	11.1	**		23/32	18.3	4.3	1951
904H-24	35358	24	609.6	7/16	11.1	**		23/32	18.3	5	2268

**For 7/16" Hex or 1/2" Round with 3 Flats, 1/4" Wide

International Tel: +1.815.397.7070
Fax: +1.815.397.9247

Canada Tel: 800.435.0786
Fax: 800.524.2853

USA Tel: 800.435.0786
Fax: 800.451.2632

149G E-Z Bore® Bits



- Double-end replaceable screw point. Choose the right feed for the material you are drilling. Fine thread for hardwoods, coarse thread for fast, effortless drilling even in soft, gummy woods.
- Tapered backside for easier removal.
- Open design won't clog with wood chips.
- Three milled flats for use in portable electric or pneumatic drills and stationary boring machines.

CAT. NO.	UPC NO.	DESCRIPTION
4236AV	05133	R Screw Point for 149G - 1, 149G - 1-1/8, 149G - 1-1/4, 149G - 1-3/8, 149G - 1-1/2, 149G - 1-3/4, 149G - 2, 149G - 2-1/8, 149G - 2-1/4, 149G - 2-9/16 and 149G - 3
18358	18358	R Screw Point for 149G-3-5/8 and 4-5/8

CAT. NO.	UPC NO.	HOLE DIA.		OVERALL LENGTH		PIPE & CONDUIT SIZE	WEIGHT	
		INCH	mm	INCH	mm		LBS.	g
149G-1	34985	1	25.4	5	127.0	1/2"	.4	18
149G-1-1/8	29388	1-1/8	28.6	5	127.0	1/2" & 3/4"	.3	137
149G-1-1/4	29389	1-1/4	31.8	5	127.0	3/4"	.3	137
149G-1-3/8	29390	1-3/8	34.9	5	127.0	—	.4	182
149G-1-1/2	29391	1-1/2	38.1	5	127.0	1"	.4	182
149G-1-3/4	29392	1-3/4	44.4	5	127.0	1-1/4"	.5	227
149G-2	34986	2	50.8	5	127.0	—	.6	273
149G-2-1/8	29393	2-1/8	54.0	5	127.0	1-1/2"	.7	318
149G-2-1/4	29395	2-1/4	57.2	5	127.0	—	.7	318
149G-2-9/16	29396	2-9/16	65.1	5	127.0	2"	.8	363
149G-3	34987	3	76.2	5	127.0	2-1/2"	1.1	499
149G-3-5/8	29398	3-5/8	92.1	6-1/4	158.8	3"	2.1	953
149G-4-5/8	29400	4-5/8	117.5	6-1/4	158.8	4"	2.6	1179

Conduit and Pipe Bit Sets



1441 / 34995
Contractor's Bit Kit

- Complete assortment of the most commonly used E-Z Bore bits.
- High-impact, rugged plastic carrying case.
- Full complement of accessories conveniently stored.

CAT. NO.	UPC NO.	DESCRIPTION	WEIGHT	
			LBS.	kg
1441	34995	Contractor's Bit Kit	6	2.72

CAT. NO.	UPC NO.	DESCRIPTION	KIT CAT./UPC NO.
			1441/34995
149G-1	34985	1" (25.4 mm) E-Z Bore Bit	✓
149G-1-1/8	29388	1-1/8" (28.6 mm) E-Z Bore Bit	✓
149G-1-1/4	29389	1-1/4" (31.8 mm) E-Z Bore Bit	✓
149G-1-1/2	29391	1-1/2" (38.1 mm) E-Z Bore Bit	✓
149G-1-3/4	29392	1-3/4" (44.4 mm) E-Z Bore Bit	✓
149G-2-1/8	29393	2-1/8" (54.0 mm) E-Z Bore Bit	✓
149G-2-9/16	29396	2-9/16" (65.0 mm) E-Z Bore Bit	✓
4236AV	05133	Double End Screw Point	✓
51376	51376	1/8" Allen Wrench	✓
52144	52144	5/32" Allen Wrench	✓
904-5-1/2	34996	5-1/2" Bit Extension	✓
34997	34997	Plastic Case	✓

Self-Feeding Spade Bits

NEW



34AR6

Bore hardwood, softwood, plywood and drywall.

- Innovative self-feeding design requires less effort and reduces vibration.
- Unique tapered design allows existing hole enlargement.
- 1/4" Quick change hex shank.
- Forged and heat treated for long life.
- For use in 1/4" (6.4 mm) or larger power drills.
- Hole in top center of bit for wire pulling.
- See "Bit Extensions" (page 72) if more length required.
- P.O.P. Packaged.



SPADE BIT KIT

CAT. NO.	UPC NO.	DESCRIPTION	WEIGHT	
			LB.	g
34AR-6	03710	Self-Feeding Spade Bit Kit (6PC)	.83	376.48

34A SPADE BITS – LENGTH 6-1/4" (158.8 mm)

CAT. NO.	UPC NO.	HOLE DIA.		HEX SHANK		WEIGHT		KIT CAT./UPC NO. 34AR-6/ 03710
		INCH	mm	INCH	mm	LBS.	g	
34A-3/8	03711	3/8	9.5	1/4	6.4	.09	40.8	1
34A-1/2	03712	1/2	12.7	1/4	6.4	.1	45.3	1
34A-5/8	03713	5/8	15.9	1/4	6.4	.1	45.3	1
34A-3/4	03714	3/4	19.1	1/4	6.4	.1	45.3	1
34A-7/8	03715	7/8	22.2	1/4	6.4	.12	54.4	1
34A-1	03716	1	25.4	1/4	6.4	.12	54.4	1

Spade Bits



Bore hardwood, softwood, plywood and drywall.

- Forged and heat treated for long life.
- For use in 1/4" (6.4 mm) or larger power drills.
- Hole in top center of bit for wire pulling.
- See "Bit Extensions" (page 72) if more length required.
- P.O.P. Packaged.

33A SPADE BITS – LENGTH 6-1/4" (158.8 mm)

CAT. NO.	UPC NO.	HOLE DIA.		HEX SHANK		WEIGHT		KIT CAT./UPC NO. 33AR-6/ 20364
		INCH	mm	INCH	mm	LBS.	g	
33A-1/4	20344	1/4	6.4	1/4	6.4	.05	23.0	
33A-3/8	20346	3/8	9.5	1/4	6.4	.09	40.8	1
33A-1/2	20348	1/2	12.7	1/4	6.4	.1	45.3	1
33A-5/8	20350	5/8	15.9	1/4	6.4	.1	45.3	1
33A-3/4	20352	3/4	19.1	1/4	6.4	.1	45.3	1
33A-7/8	20354	7/8	22.2	1/4	6.4	.12	54.4	1
33A-1	20357	1	25.4	1/4	6.4	.12	54.4	1
33A-1-1/8	20358	1-1/8	28.6	1/4	6.4	.15	68.0	
33A-1-1/4	20359	1-1/4	31.8	1/4	6.4	.15	68.0	
33A-1-3/8	20360	1-3/8	34.9	1/4	6.4	.16	72.6	
33A-1-1/2	20361	1-1/2	38.1	1/4	6.4	.16	72.6	

33L SPADE BITS – LENGTH 16" (406.4 mm)

CAT. NO.	UPC NO.	HOLE DIA.		HEX SHANK		WEIGHT	
		INCH	mm	INCH	mm	LBS.	g
33L-1/4	31535	1/4	6.4	1/4	6.4	.22	99
33L-3/8	31536	3/8	9.5	1/4	6.4	.32	145
33L-1/2	31537	1/2	12.7	1/4	6.4	.33	150
33L-5/8	31539	5/8	15.9	1/4	6.4	.4	181
33L-3/4	31540	3/4	19.1	1/4	6.4	.4	181
33L-7/8	31541	7/8	22.2	1/4	6.4	.55	250
33L-1	31542	1	25.4	1/4	6.4	.33	150
33L-1-1/8	31543	1-1/8	28.6	1/4	6.4	.58	263
33L-1-1/4	31544	1-1/4	31.8	1/4	6.4	.56	254
33L-1-1/2	31545	1-1/2	38.1	1/4	6.4	.6	272

SPECIFICATIONS

Length	33A Spade Bit - 6-1/4" (158.8 mm)
	33L Spade Bit - 16" (406.4 mm)

SPADE BIT KITS

CAT. NO.	UPC NO.	DESCRIPTION	WEIGHT	
			LB.	g
33AR-6	20364	Spade Bit Kit (see chart)	0.6	272

D'VersiBITS & ACCESSORIES

D'VersiBIT® System



A new twist to an old problem.

These flexible steel drill bits are the right tools for installing wire or cable inside existing walls.

It bends to meet your needs!

Fishing wire or cable through existing walls used to be frustrating and time-consuming, but the D'VersiBIT has made it as simple as bowing the spring steel shaft in the direction you want to drill and turning on the power. Proven in the field to deliver accurate and professional results in many applications. Bits range from 3/16" to 1" (4.8 to 25.4 mm) in diameter and in shaft length from 12" to 72" (304.8 to 1828.8 mm).

The D'VersiBIT System makes it possible to easily accomplish even complex installations. This patented system attaches a quality drill bit to a long flexible spring steel shaft. When used with the Placement Tool, this flexibility makes it possible to easily manipulate the bit within walls. After drilling, attach a D'VersiGRIP to the hole in the drill and pull wire or cable back through the wall.



Type M, Masonry



- For drilling in masonry walls and through plaster.
- Recommended for use with Abrasion Shield to reduce friction and abrasion as the shaft turns against masonry.

Type HS, Wood



- Designed for aggressive cutting in all types of wood.
- Made from high-speed steel to ensure long life.
- Replaces Bellhanger bits on 12", 18" and 24" lengths.

CAT. NO.	UPC NO.	DESCRIPTION
99104	99104	54" x 1" Shipping Tube B with End (Sold only in minimum quantity of 6 in same length.)
99105	99105	72" x 1" Shipping Tube B with End (Sold only in minimum quantity of 6 in same length.)

BIT DIAMETER INCH (mm) COLOR CODE	SHAFT LENGTH		SHAFT DIA.		TYPE M MASONRY		TYPE HS HIGH SPEED STEEL	
	INCH	mm	INCH	mm	CAT. NO.	UPC NO.	CAT. NO.	UPC NO.
1/4" (6.4 mm) Blue	12	304.8	3/16	4.8	—	—	1412D	39913
	18	457.2	3/16	4.8	—	—	1418D	38744
	24	609.6	3/16	4.8	—	—	1424D	38745
	36	914.4	3/16	4.8	—	—	1436D	38746
3/8" (9.5 mm) Black	12	304.8	3/16	4.8	—	—	3812D	39914
	24	609.6	3/16	4.8	—	—	3824D	38750
	36	914.4	3/16	4.8	—	—	3836D	38751
	54	1371.6	3/16	4.8	06-03-54M	38668	3858D	38752
	72	1828.8	3/16	4.8	—	—	3872D	38753
1/2" (12.7 mm) Green	36	914.4	3/16	4.8	—	—	1236D	38756
	54	1371.6	3/16	4.8	—	—	1258D	38757
	72	1828.8	3/16	4.8	—	—	1272D	38758
	54	1371.6	1/4	6.4	08-04-54M	38678		

R = REPLACEMENT PART **A** = ACCESSORY

Holemaking

USA Tel: 800.435.0786
Fax: 800.451.2632

Canada Tel: 800.435.0786
Fax: 800.524.2853

International Tel: +1.815.397.7070
Fax: +1.815.397.9247

D'VersiBIT® System

CAT. NO.	UPC NO.	DESCRIPTION
99104	99104	54" x 1" Shipping Tube B with End (Sold only in minimum quantity of 6 in same length.)
99105	99105	72" x 1" Shipping Tube B with End (Sold only in minimum quantity of 6 in same length.)

Type A, Auger



- Wood-type auger bit with screw point.
- Pulls itself through wood, avoids walking or skidding.
- Excellent for drilling in soft woods or through thin sections.
- Slow back-taper allows for easy retrieval.

Type B, Combination with Screw Point



- For aggressive chip removal in many types of woods.
- Screw point for easy starting and pulling through wood.
- With screw point removed, this bit can be ground to function like a standard combination bit.

Type C, Combination



- For drilling in tough woods and thick obstacles.
- Drilling speed relative to pressure applied.
- Chips can be brought easily out of the hole.

BIT DIA. INCH (mm)	SHAFT LENGTH		SHAFT DIA.		TYPE A AUGER		TYPE B COMBINATION WITH SCREW POINT		TYPE C COMBINATION	
	INCH	mm	INCH	mm	CAT. NO.	UPC NO.	CAT. NO.	UPC NO.	CAT. NO.	UPC NO.
1/4"	36	914.4	5/32	4.0	—	—	—	—	04-03-36C	38112
(6.4 mm)	54	1371.6	5/32	4.0	—	—	—	—	04-03-54C	38113
Blue	72	1828.8	5/32	4.0	—	—	—	—	04-03-72C	38114
3/8"	36	914.4	3/16	4.8	06-03-36A	38067	06-03-36B	38092	06-03-36C	38117
(9.5 mm)	54	1371.6	3/16	4.8	06-03-54A	38068	06-03-54B	38093	06-03-54C	38118
Black	72	1828.8	3/16	4.8	06-03-72A	38069	06-03-72B	38094	06-03-72C	38119
1/2"	36	914.4	3/16	4.8	08-03-36A	38072	08-03-36B	38097	08-03-36C	38122
(12.7 mm)	54	1371.6	3/16	4.8	08-03-54A	38073	08-03-54B	38098	08-03-54C	38123
Green	72	1828.8	3/16	4.8	08-03-72A	38074	08-03-72B	38099	08-03-72C	38124
9/16"	36	914.4	3/16	4.8	09-03-36A	38077	09-03-36B	38102	—	—
(14.3 mm)	54	1371.6	3/16	4.8	09-03-54A	38078	09-03-54B	38103	09-03-54C	38128
Orange	72	1828.8	3/16	4.8	09-03-72A	38079	09-03-72B	38104	09-03-72C	38129
3/4"	36	914.4	1/4	6.4	12-04-36A	38082	—	—	—	—
(19.1 mm)	54	1371.6	1/4	6.4	12-04-54A	38083	—	—	12-04-54C	38133
Red	72	1828.8	1/4	6.4	12-04-72A	38084	—	—	12-04-72C	38134
1"	36	914.4	1/4	6.4	16-04-36A	38087	—	—	—	—
(25.4 mm)	54	1371.6	1/4	6.4	16-04-54A	38088	—	—	—	—
White	72	1828.8	1/4	6.4	16-04-72A	38089	—	—	—	—

D'VersiBIT® Starter Kit



- All the tools to complete a typical wiring job.
- Includes 09-03-54B bit, 712P placement tool and 150 pulling grip.

CAT. NO.	UPC NO.	DESCRIPTION
DBITKIT	01630	D'VersiBIT Kit with 9/16" Bit, Placement Tool and Grip for Pulling 1/2" OD Wire

Extensions



SPECIFICATIONS

Size 3XT 36, 3XT 54, 3XT 72 - connecting end diameter 7/16" (11.1 mm)
4XT 36, 4XT 54, 4XT 72 - connecting end diameter 5/8" (15.9 mm)

- Sizes for 3/16" (4.8 mm) and 1/4" (6.4 mm) diameter shafts.
- Connect to chuck end of D'VersiBIT® shaft to increase the length of the bit.

CAT. NO.	UPC NO.	USE WITH	
		SHAFT DIA.	LENGTH
3XT 36	38685	3/16" (4.8 mm)	36" (914.4 mm)
3XT 54	38686	3/16" (4.8 mm)	54" (1371.6 mm)
3XT 72	38687	3/16" (4.8 mm)	72" (1828.8 mm)
4XT 36	38688	1/4" (6.4 mm)	36" (914.4 mm)
4XT 54	38689	1/4" (6.4 mm)	54" (1371.6 mm)
4XT 72	38690	1/4" (6.4 mm)	72" (1828.8 mm)

Placement Tool



- Allows placement of the drill bit at any point within the wall.
- Helpful in judging where the bit will be during drilling to avoid accidentally drilling through the wall.
- Useful for vertical and horizontal placements.

CAT. NO.	UPC NO.	DESCRIPTION
712P	38350	D'VersiBIT® Placement Tool

SPECIFICATIONS

Function Use to position all bit and shaft sizes.

Wire and Cable Pulling Grips



- Clip attaches to hole in bit, mesh basket holds wire or cable during recovery, swivel reduces twisting.
- For use with bits 3/8" (9.5 mm) diameter or larger.
- A variety of sizes for pulling wire and cable.

CAT. NO.	UPC NO.	DESCRIPTION
125	38691	D'VersiGRIP for Pulling Single Wire with 3/8" to 1/2" (9.5 mm to 12.7 mm) Bits.
150	38692	D'VersiGRIP for Pulling 1/2" (12.7 mm) OD Wire with 1/2" to 9/16" (12.7 to 14.3 mm) Bits.
168	38693	D'VersiGRIP for Pulling 3/4" (19.1 mm) OD Wire with 3/4" to 1" (19.1 to 25.4 mm) Bits

SPECIFICATIONS

Function For pulling wire, cable or fish tape through walls.
Pulling Strength 50 lbs.

Abrasion Shield



SPECIFICATIONS

Function Protects shaft and hand while drilling with any size or type D'VersiBIT®.
Length 48" (1219.2 mm)

- Tube fits both shaft sizes.
- Prevents insulation from wrapping around shaft.
- Protects shaft of masonry bits as they turn against masonry walls.
- Protects hand holding shaft during drilling.

CAT. NO.	UPC NO.	DESCRIPTION
606AS	38696	Abrasion Shield

STEEL HOLE CUTTERS

Quick Change Stainless Steel Hole Cutters



660

- Cuts stainless steel quickly and easily.
- Quick Change arbor allows you to change cutter heads with a simple push and a turn. Use the same arbor for different size cutting heads.
- Removable cutter heads available in sizes from 5/8" through 3".
- Flange stop prevents over-drilling.
- Ejector spring on all sizes above 3/4" makes removal of slug easier.
- Replaceable, cobalt-steel pilot drill with split-point tip to prevent walking.
- Precision carbide teeth for optimum performance and durability.
- Minimum chuck size of 3/8"

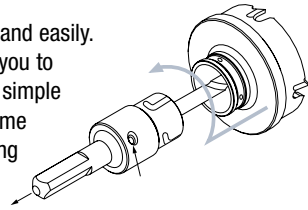

KITS

CAT. NO.	UPC NO.	DESCRIPTION
660	05766	7/8", 1-1/8", 1-3/8", 1-3/4", 2" Cutter Heads; Arbor, Hex Key and Case
655	05820	7/8", 1-1/8", 1-3/8" Cutter Heads; Arbor, Hex Key and Case
03581	03581	R 3 mm Hex Key
54274	54274	R Set Screw
55225	55225	R 1/2" Ejector Spring

INDIVIDUAL CARBIDE-TIPPED HOLE CUTTERS

CAT. NO.	UPC NO.	SIZE		CONDUIT SIZE	PG	ISO	MIN. CHUCK SIZE		KIT CAT. NO. 660/UPC NO. 05766	KIT CAT. NO. 655/UPC NO. 05820
		INCH	mm				INCH	mm		
645-5/8	05691	5/8	15.8				3/8	9.5		
645-11/16	05692	11/16	17.5				3/8	9.5		
645-3/4	05693	3/4	19.0		11		3/8	9.5		
645-13/16	05694	13/16	20.6		13	20	3/8	9.5		
645-7/8	05695	7/8	22.2	1/2"			3/8	9.5	✓	✓
645-1	05696	1	25.4			25	3/8	9.5		
645-1-1/16	05957	1-1/16	27.0				3/8	9.5		
645-1-1/8	05697	1-1/8	28.6	3/4"	21		3/8	9.5	✓	✓
645-1-7/32	05698	1-7/32	31.0				3/8	9.5		
645-1-1/4	05699	1-1/4	31.8				3/8	9.5		
645-1-5/16	05958	1-5/16	33.3			32	3/8	9.5		
645-1-3/8	05700	1-3/8	34.9	1"			3/8	9.5	✓	✓
645-1-7/16	05959	1-7/16	36.5		27		3/8	9.5		
645-1-1/2	05701	1-1/2	38.1				3/8	9.5		
645-1-3/4	05702	1-3/4	44.4	1-1/4"			3/8	9.5	✓	
645-2	05703	2	50.8	1-1/2"	50		3/8	9.5	✓	
645-2-1/8	05960	2-1/8	54.0		42		3/8	9.5		
645-2-1/4	05704	2-1/4	57.2		48		3/8	9.5		
645-2-3/8	05961	2-3/8	60.3				3/8	9.5		
645-2-1/2	05705	2-1/2	63.5	2"	63		3/8	9.5		
645-2-5/8	05706	2-5/8	66.7				3/8	9.5		
645-3	05707	3	76.2				3/8	9.5		

ARBORS AND PILOT DRILLS

CAT. NO.	UPC NO.	DESCRIPTION	KIT CAT. NO. 660/UPC NO. 05766	KIT CAT. NO. 655/UPC NO. 05820
645-011	05752	Quick Change Arbor for sizes 5/8" through 2-1/4", 3/8" shank	✓	✓
645-022	05753	Quick Change Arbor for sizes 2-3/8" through 3", 1/2" shank		
645-001	05761	Pilot Drill for sizes 5/8" through 2-1/4"	✓	✓
645-002	05762	Pilot Drill for sizes 2-3/8" through 3"		
55225	55225	Ejector Spring		

NOTE: TO EXTEND THE LIFE OF YOUR TOOL, SEE CUTTING/THREADING OIL ON PAGE 376.

Carbide-Tipped Hole Cutters



- Multiple tungsten carbide tips for long life and smooth cutting.
- Cut fast, accurate, high quality holes in stainless steel, copper, aluminum, steel.
- Flange stop prevents over-drilling.
- Replaceable cobalt steel pilot drill, with split-point tip design, to improve performance and resist walking; eliminates need for "center punch."

KIT

CAT. NO.	UPC NO.	DESCRIPTION
635	03599	7/8", 1-1/8", 1-3/8" Cutterheads; Pilot Drill, Hex Key and Case Weight 1.2 lbs. (.54 kg)

CARBIDE-TIPPED HOLE CUTTERS

CAT. NO.	UPC NO.	SIZE		CONDUIT SIZE	PG	ISO	MIN. CHUCK SIZE		WEIGHT		KIT CAT. NO. 635/UPC NO. 03599
		INCH	mm				INCH	mm	LBS.	g	
625-3/4	38324	3/4	19.0		11		1/4	6.4	.02	9	
625-13/16	38325	13/16	20.6		13	20	1/4	6.4	.02	9	
625-7/8	38326	7/8	22.2	1/2"	16		1/4	6.4	.33	150	✓
625-1	38327	1	25.4			25	3/8	9.5	.02	9	
625-1-1/8	38328	1-1/8	28.6	3/4"	21		3/8	9.5	.43	195	✓
625-1-7/32	38329	1-7/32	30.5				3/8	9.5	.44	200	
625-1-1/4	38330	1-1/4	31.7				3/8	9.5	.33	150	
625-1-3/8	38331	1-3/8	35.0	1"			3/8	9.5	.47	213	✓
625-1-1/2	38332	1-1/2	38.1				3/8	9.5	.37	168	
625-1-3/4	38333	1-3/4	44.4	1-1/4"			3/8	9.5	.40	182	
625-2	38334	2	50.8	1-1/2"		50	3/8	9.5	.50	227	
625-2-1/2	38336	2-1/2	63.5	2"			1/2	12.7	.67	304	

All hole cutters are packaged in Point of Purchase blister pack.

SPECIFICATIONS

Maximum Cutting Depth 8 ga. (4 mm)

REPLACEMENT PILOT DRILLS

CUTTER SIZE RANGE		PILOT DRILL		HEX SET SCREW		WT.	
INCH	mm	CAT. NO.	UPC NO.	SIZE	CAT./UPC NO.	LBS.	g
3/4-2	19.0-50.8	625-001	39872	3 mm	54274	.19	86
2-1/2	63.5	625-002	38390	4 mm	54295	.28	127

◇ Point of Purchase Package

Ultra Cutters



- Lasts 10 times longer than standard hole saws.
- Precision-ground teeth cut smooth, burr-free holes with ease.
- 1/4" (6.35 mm) capacity.
- Durability and speed provide low cost per hole.
- Split-point pilot drill prevents "walking" – makes accurate hole placement easy.
- Spring-loaded slug ejector saves time.
- No tool required to change cutter sizes.
- Less chance of broken teeth because the saw body is machined out of solid, high-speed steel.



KIT

CAT. NO.	UPC NO.	DESCRIPTION
930	10214	Ultra Cutter Kit: Includes 7/8" to 2-1/2" Cutters, two Small Arbors for extended assembly to 7/8" and 1-1/8" Cutters, Large Arbor, Hex Wrench and Case. For conduit sizes 1/2" through 2".

ULTRA CUTTERS

CAT. NO.	UPC NO.	ACTUAL HOLE SIZE		HOLE DIAMETER			
		IN.	mm	CONDUIT	PG	ISO	COPPER PIPE
925-7/8	10157	7/8	22.5	1/2"	Pg-16		5/8"
925-1-1/8	10158	1-1/8	28.6	3/4"	Pg-21		
925-1-7/32	01643	1-7/32	30.5				
925-1-5/16	04823	1-5/16	33.3				
925-1-3/8	10159	1-3/8	35.0	1"			
925-1-3/4	10160	1-3/4	44.4	1-1/4"			1-1/2"
925-2	10161	2	50.8	1-1/2"		ISO-50	
925-2-1/2	10162	2-1/2	63.5			ISO-63	2"

ARBORS AND PILOT DRILLS

CAT. NO.	UPC NO.	DESCRIPTION
925-011	10163	R Small Arbor with Pilot Drill for 7/8" to 1-7/32" Size Cutter
925-022	10185	R Large Arbor with Pilot Drill for 1-3/8" to 2-1/2" Size Cutter
925-001	10186	R Small Pilot Drill
925-002	10211	R Large Pilot Drill

RECOMMENDED CUTTING SPEEDS

CUTTER SIZE	RPM
7/8" (22.5 mm)	350
1-1/8" (28.6 mm)	270
1-3/8" (35.0 mm)	220
1-3/4" (44.4 mm)	175
2" (50.8 mm)	150
2-1/2" (63.5 mm)	120

HOLE SAW TYPE	AVERAGE* CUTTING TIME (SEC/HOLE)	AVERAGE* NUMBER OF HOLES	AVERAGE* COST/HOLE (\$)
Bi-Metal	25	50	0.10
Ultra Cutter	10	500	0.10
Carbide-Tipped Cutter	10	500	0.20

*For 7/8" Hole in 14ga Mild Steel



NOTE: TO EXTEND THE LIFE OF YOUR TOOL, SEE CUTTING/THREADING OIL ON PAGE 376.

R = REPLACEMENT PART **A** = ACCESSORY

Quick Change Hole Saw Kit



02802

Quick Change Arbor Features:

- New arbor allows for rapid mounting or removal of hole saws.
- Faster, easier slug removal.
- Drill pilot hole without saw:
 1. Eliminates the "bite" when saw crashes into the steel.
 2. Provides better ergonomics - reduces stress on wrist, arm and hand.
 3. Eliminates obstructed view from hole saw.
- Only one arbor required from 7/8" to 6" (7/16" shank recommended for hole saws above 2-1/2").
- Works with recessed light and carbide grit hole saw products as well.
- Adapters re-usable to minimize costs.
- Universal - works with any brand hole saw.

Kit contains Bi-metal hole saws for 1/2" through 2" conduit sizes.

See page 82 for details.

CAT. NO.	UPC NO.	DESCRIPTION
830Q	02806	Quick Change Hole Saw Kit for 1/2" through 2" Conduit Sizes
02800	02800	R 5/16" Arbor, Minimum Chuck Size 3/8"
02801	02801	R 7/16" Arbor, Minimum Chuck Size 1/2"
02802	02802	R Retrofit Kit - upgrade 3 Hole Saws up to 1-9/16" to Quick Change
02803	02803	R Small Adapters for 9/16" to 1-9/16" Saws Qty. 10
02804	02804	R Large Adapters for 1-5/8" to 6" Saws Qty. 3
02805	02805	R Bushings for 1-1/4" to 1-9/16" Saws Qty. 5

SPECIFICATIONS

Shank	Available for 3/8" and heavy duty 1/2" chuck sizes
Arbor length	5-1/2" with pilot drill
Arbor weight	0.5 lbs (227 g)
Arbor operation	Push collar to lock on saw; pull to release saw
Arbor pilot drill	37623, 4-1/8" x 1/4" (104.8 mm x 6.4 mm)

Deburring Tool

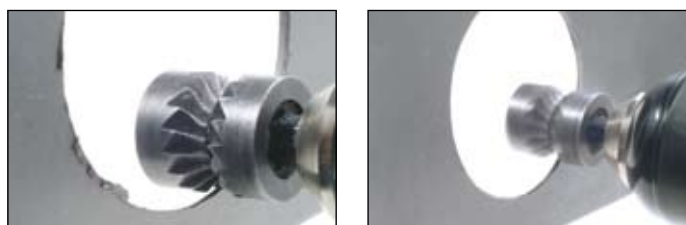

- Cleans burrs from both sides of the hole in seconds, saving time and labor.
- Works with any hole size or shape 3/4" or larger.
- Use with existing drills, battery or electric-powered.
- Ensures safety, less chance of personnel or equipment being cut on sharp edges.
- Patent pending.

SPECIFICATIONS

Material thickness	Deburs up to 10 gauge
Material type	Mild and stainless steel, copper, brass, aluminum
Shank	Minimum chuck size 3/8"
Cutter size	13/16" diameter
Operation	Run tool clockwise to deburr, counterclockwise to clear chips

CAT. NO.	UPC NO.	DESCRIPTION
11170	11170	Deburring Tool
11180	11180	R Cutter 3-pack

NOTE: TO EXTEND THE LIFE OF YOUR TOOL, SEE CUTTING/THREADING OIL ON PAGE 376.

R = REPLACEMENT PART **A** = ACCESSORY

USA Tel: 800.435.0786
Fax: 800.451.2632

Canada Tel: 800.435.0786
Fax: 800.524.2853

International Tel: +1.815.397.7070
Fax: +1.815.397.9247

HOLE SAWS

Bi-Metal Hole Saws



- Cut through steel, tin, aluminum, fiberglass, wood and plastic.
- Deep 1-5/8" (41.3 mm) cutting depth allows for cutting through 2" x 4" wood studs.
- Extra-tough M42 alloy blade – we use the highest grade of tool steel to outlast competitor's blades. That beats premature saw replacement and saves you money.
- Steam oxide finish – no paint to gum up and slow cutting. The saw runs cooler for longer life and better performance.
- Extra-thick backplate minimizes vibration for smoother, easier, less tiring cutting.
- Made in USA

*See page 81 for Quick Change adapter information.

CAT. NO.	UPC NO. STD. PACK	UPC NO. BULK PACK	UPC NO. POINT OF PURCHASE	ACTUAL HOLE SIZE		HOLE DIA.			COPPER PIPE SIZE	USE WITH QUICK CHANGE ARBOR NO.	USE WITH STD. ARBOR NO.	WEIGHT	
				INCH	mm	CONDUIT	PG	ISO				LBS.	g
825-9/16	19131		—	9/16	14.3				1/8"	02800*	37157, 37155, or 38522	.1	46
825-5/8	19132		—	5/8	15.9		Pg-9		1/4"			.1	46
825-11/16	19133		—	11/16	17.5			ISO-16	3/8"			.1	46
825-3/4	19134	29828	00140	3/4	19.0		Pg-11		1/2"			.1	46
825-13/16	19135		—	13/16	20.6		Pg-13	ISO-20	1/2"			.1	46
825-7/8	19136	29829	38495	7/8	22.2	1/2"	Pg-16		5/8"			.1	46
825-15/16	19137		—	15/16	23.8							.1	46
825-1	19138		—	1	25.4			ISO-25	3/4"			.1	46
825-1-1/16	19140		—	1-1/16	27.0							.1	46
825-1-1/8	19141	29831	38496	1-1/8	28.6	3/4"	Pg-21		3/4"			.1	46
825-1-3/16	19143		—	1-3/16	30.2					.2	91		
825-1-1/4	19144		—	1-1/4	31.7				1"	.2	91		
825-1-5/16	19145		—	1-5/16	33.3			ISO-32		.2	91		
825-1-3/8	19146	29832	38497	1-3/8	35.0	1"				.1	46		
825-1-7/16	19147		—	1-7/16	36.5		Pg-29			.2	91		
825-1-1/2	19148		—	1-1/2	38.1				1-1/4"	.2	91		
825-1-9/16	19149		—	1-9/16	39.7					.2	91		
825-1-5/8	19150		—	1-5/8	41.3			ISO-40		.2	91		
825-1-11/16	19151		—	1-11/16	42.9					.3	137		
825-1-3/4	19152	29834	38498	1-3/4	44.4	1-1/4"			1-1/2"	.2	91		
825-1-13/16	19153		—	1-13/16	46.0					.2	91		
825-1-7/8	19154		—	1-7/8	47.6		Pg-36			.3	137		
825-2	19155	29835	38500	2	50.8	1-1/2"		ISO-50		.2	91		
825-2-1/16	19157		—	2-1/16	52.4					.3	137		
825-2-1/8	19158		—	2-1/8	54.0		Pg-42			.3	137		
825-2-1/4	19159		—	2-1/4	57.2				2"	.3	137		
825-2-5/16	19160		—	2-5/16	58.7					.5	227		
825-2-3/8	19161		—	2-3/8	60.3		Pg-48		2"	.3	137		
825-2-1/2	19162	29836	38502	2-1/2	63.5	2"		ISO-63	2"	.3	137		
825-2-9/16	19163		—	2-9/16	65.0					.4	182		
825-2-5/8	19164		—	2-5/8	66.7					.4	182		
825-2-3/4	19165		—	2-3/4	69.8					.4	182		
825-2-7/8	19166		—	2-7/8	73.0					.4	182		
825-3	19167	29837	00141	3	76.2	2-1/2"			2-1/2"	.5	227		
825-3-1/8	19168		—	3-1/8	79.4					.5	227		
825-3-1/4	19169		—	3-1/4	82.5					.6	273		
825-3-3/8	19170		—	3-3/8	85.7					.6	273		
825-3-1/2	19171		—	3-1/2	88.9					.6	273		
825-3-5/8	19172	29838	00142	3-5/8	92.1	3"				.6	273		
825-3-3/4	19174		—	3-3/4	95.2					.7	318		
825-3-7/8	19175		—	3-7/8	98.4				3-1/2"	.7	318		
825-4	19176		—	4	101.6					.7	318		
825-4-1/8	19177		00143	4-1/8	104.8	3-1/2"			3-1/2"	.8	363		
825-4-1/4	19178		—	4-1/4	108.0				4"	.8	363		
825-4-3/8	19179		—	4-3/8	111.1					.8	363		
825-4-1/2	19180		00144	4-1/2	114.3	4"				.9	409		
825-4-3/4	19181		—	4-3/4	120.6					1.1	499		
825-5	19182		—	5	127.0					1.2	545		
825-5-1/2	19183		—	5-1/2	139.7				5"	1.2	545		
825-6	19184		—	6	152.4					1.4	636		

Carbide-Grit Hole Saws



- Long-lasting tungsten carbide-grit delivers extremely clean, smooth cuts through tile, cement board, and other abrasive materials. Perfect for cutting holes in Quazite® enclosure or hardy board siding for 3-0 box installation.
- Rugged construction for enduring performance.
- Use with Arbors listed on page 84.

CARBIDE GRIT HOLE SAWS







CAT. NO.	UPC NO.	ACTUAL HOLE SIZE		HOLE DIAMETER		
		INCH	mm	CONDUIT	PG	ISO
725-7/8	10072	7/8	22.2	1/2"	16	
725-1-1/8	10073	1-1/8	28.6	3/4"	21	
725-1-3/8	10075	1-3/8	35.0	1"		
725-1-1/2	10076	1-1/2	38.1			
725-1-3/4	10077	1-3/4	44.4	1-1/4"		
725-2	10078	2	50.8	1-1/2"		50
725-2-1/8	10079	2-1/8	54.0			
725-2-1/2	10080	2-1/2	63.5	2"		63
725-3-5/8	10081	3-5/8	92.1	3"		
725-4-1/8	10687	4-1/8	104.8	3-1/2"		
725-4-1/2	01879	4-1/2	114.3	4"		



PILOT DRILL

CAT. NO.	UPC NO.	DESCRIPTION
725-001	10082	1/4" Carbide Tipped Pilot Drill

Arbors with Replacement High-Speed Steel Pilot Drill Bits

- The best arbor in the industry ensures a solid connection without any gaps or wobbling.
- Arbors include replaceable, high-speed steel pilot drill.
- Pilot drills have unique split-point tip design.
- Use with Greenlee bimetal hole saws, recessed light hole saws and carbide-grit hole saws (carbide-tipped pilot drill sold separately).
- Can be used with Greenlee #901 or #904 bit extensions.

ARBORS							
Cat./UPC No.							
Standard Pack	N/A	37157	38522	37155	N/A	37154	37156
Point of Purchase Pack	02800	38507	38524	38505	02801	38504	38506
Bulk Pack	N/A	37157B	38522B	37155B	N/A	37154B	37156B
Shank	Hex	Round with 3 flats	Hex	Hex	Hex	Hex	Hex
Shank Size	5/16" (7.9 mm)	1/4" (6.4 mm)	5/16" (7.9 mm)	7/16" (11.1 mm)	7/16" (11.1 mm)	5/16" (7.9 mm)	7/16" (11.1 mm)
Min. Chuck Size	3/8" (9.5 mm)	1/4" (6.4 mm)	3/8" (9.5 mm)	1/2" (12.7 mm)	1/2" (12.7 mm)	3/8" (9.5 mm)	1/2" (12.7 mm)
Use With	9/16" - 2" (14.3 - 50.8 mm)	9/16" - 1-3/16" (14.3 - 30.2 mm) Hole Saws	9/16" - 1-3/16" (14.3 - 30.2 mm) Hole Saws	9/16" - 1-3/16" (14.3 - 30.2 mm) Hole Saws	9/16"-6" (14.3 - 152.4mm)	1-1/4" - 2" (31.8 - 50.8 mm) Hole Saws	1-1/4" - 6" (31.8 - 152.4 mm) Hole Saws and all Greenlee Recessed Light Hole Saws
Weight	0.5 lbs (227 g)	.2 lbs (91 g)	.2 lbs (91 g)	.2 lbs (91 g)	0.5 lbs. (227 g)	.5 lbs (227 g)	.5 lbs. (227 g)

HIGH-SPEED STEEL PILOT DRILLS		
Cat./UPC No.		
Standard Pack	37623	38526
Point of Purchase Pack	39873	39893
Bulk Pack Qty: 50 per pack	37624	38991
Length	4-1/8" (104.8 mm)	3-1/4" (82.5 mm)
Diameter	1/4" (6.4 mm)	1/4" (6.4 mm)
Use With Greenlee Arbor #'s	37157, 37155, 37156 & 37154	38522, 37155, 37156 & 37154
Weight	.2 lbs (91 g)	.2 lbs (91 g)

CARBIDE-TIPPED PILOT DRILLS	
Cat./UPC No.	
Standard Pack	10082
Length	4-1/8" (104.8 mm)
Diameter	1/4" (6.4 mm)
Use With Greenlee Arbor #'s	37157, 37155, 37156 & 37154
Weight	.2 lbs (91 g)

* Quazite is a registered trademark of Strongwell Corporation.
See page 81 for Quick Change adapter information.

Bi-Metal Hole Saw Kits



835 / 27538



834 / 19913



830 / 19192



889 / 03478



890 / 03479



891 / 03480

- Several electrician's kits available providing an assortment of the most commonly used Greenlee variable pitch hole saw sizes and arbors.
- High-impact, rugged plastic carrying case.

CAT. NO.	UPC NO.	DESCRIPTION	WEIGHT	
			LBS.	kg
830	19192	Hole Saw Kit for 1/2" through 2" Conduit Sizes	2.7	1.2
834	19913	Hole Saw Kit for 2-1/2" through 4" Conduit Sizes	6.2	2.8
835	27538	Hole Saw Kit for 1/2" through 4" Conduit Sizes	7.7	3.5
830Pg	29209	Hole Saw Kit for Pg-9 through Pg-48	2.7	1.2
889	03478	Plumber's Hole Saw Kit – 3/4" through 2-1/4" Conduit Sizes	2.3	1.0
890	03479	Industrial Maintenance Hole Saw Kit – 3/4" through 4-3/4" Conduit Sizes	9.7	4.4
891	03480	Electrician's/Plumber's Hole Saw Kit - 3/4" through 2-1/2" Conduit Sizes	3.5	1.6

CAT. NO.	UPC NO.	DESCRIPTION	KIT CAT./UPC NO.						
			830/ 19192	834/ 19913	835/ 27538	830PG/ 29209	889/ 03478	890/ 03479	891/ 03480
825-3/4	19134	3/4" Hole Saw					✓	✓	✓
825-7/8	19136	7/8" Hole Saw	✓		✓	✓	✓	✓	✓
825-1	19138	1" Hole Saw						✓	✓
825-1-1/8	19141	1-1/8" Hole Saw	✓		✓	✓	✓	✓	✓
825-1-3/8	19146	1-3/8" Hole Saw	✓		✓			✓	✓
825-1-1/2	19148	1-1/2" Hole Saw					✓	✓	✓
825-1-3/4	19152	1-3/4" Hole Saw	✓		✓		✓	✓	✓
825-2	19155	2" Hole Saw	✓		✓		✓	✓	✓
825-2-1/4	19159	2-1/4" Hole Saw					✓	✓	✓
825-2-1/2	19162	2-1/2" Hole Saw	✓		✓			✓	✓
825-3	19167	3" Hole Saw		✓	✓			✓	✓
825-3-1/4	19169	3-1/4" Hole Saw						✓	✓
825-3-5/8	19172	3-5/8" Hole Saw		✓	✓			✓	✓
825-3-3/4	19174	3-3/4" Hole Saw						✓	✓
825-4-1/8	19177	4-1/8" Hole Saw		✓	✓			✓	✓
825-4-1/2	19180	4-1/2" Hole Saw		✓	✓			✓	✓
825-4-3/4	19181	4-3/4" Hole Saw						✓	✓
825-5/8	19132	Pg-9 (15.9 mm) Hole Saw				✓			
825-3/4	19134	Pg-11 (19.0 mm) Hole Saw				✓			
825-13/16	19135	Pg-13 (20.6 mm) Hole Saw				✓			
825-1-3/16	19143	30.2 mm Hole Saw				✓			
825-1-1/2	19148	Pg-29 (38.1 mm) Hole Saw				✓			
825-1-7/8	19154	Pg-36 (47.6 mm) Hole Saw				✓			
825-2-3/8	19161	Pg-48 (60.3 mm) Hole Saw				✓			
38522	38522	Arbor w/Pilot Drill	(2)						
37157	37157	Arbor w/Pilot Drill	✓		✓				
37155	37155	Arbor w/Pilot Drill	✓		✓		✓	✓	✓
37156	37156	Arbor w/Pilot Drill	✓	✓	✓	✓	✓	✓	✓
38526	38526	Pilot Drill					✓	✓	✓

RECESSED LIGHT HOLE SAWS

Recessed Light Hole Saws



- Industry's only interchangeable replacement blades.
- Strong durable back plate.
- Available in two styles – steel tooth and carbide grit.
- Made and designed in USA by Greenlee.
- Use with a power drill to cut large diameter holes for recessed lighting fixtures.
- Saws use Greenlee arbor 37156, purchased separately.

SPECIFICATIONS

Capacity	Steel Toothed Blade - up to 7/8" (22.2 mm) plywood, wood, acoustical tile and ceiling tile.
	Carbide Grit Blade - up to 7/8" (22.2 mm) drywall, plywood, wood, acoustical tile, ceiling tile, plaster and stucco.

CAT. NO.	UPC NO.	DESCRIPTION
35720	35720 R	Blade for 35712
35721	35721 R	Blade for 35713
35722	35722 R	Blade for 35714
35723	35723 R	Blade for 35715
35724	35724 R	Blade for 35716
35725	35725 R	Blade for 35717
35726	35726 R	Blade for 35718
35727	35727 R	Blade for 35719
35708	35708	Set of 5 Blade Screws

CAT./ UPC NO.	DESCRIPTION	DIAMETER	HOLEWEIGHT		USE FOR
			LBS.	kg	
35712	Steel Toothed	4-3/8" (111 mm)	.76	.34	Mini Juno, Capri,
35716	Carbide Grit	4-3/8" (111 mm)	.74	.34	Marco and Halo
35713	Steel Toothed	6-3/8" (162 mm)	1.2	.54	Halo and Capri
35717	Carbide Grit	6-3/8" (162 mm)	1.1	.50	Halo and Capri
35714	Steel Toothed	6-5/8" (168 mm)	1.3	.59	Juno and Progress
35718	Carbide Grit	6-5/8" (168 mm)	1.3	.59	Juno and Progress
35715	Steel Toothed	6-7/8" (175 mm)	1.3	.59	Lithonia, Marco,
35719	Carbide Grit	6-7/8" (175 mm)	1.4	.64	Lightolier, Progress, Capri and Precolite

Quick Cutter™ Hole Saws



- Quickest, most affordable way to cut perfect holes in ceiling tile.
- Cuts clean, precise holes that ensure no light leakage or poor-fitting installations.
- Self-sharpening, carbide-sprayed cutting tips can cut dozens of holes in very abrasive materials and still stay sharp.
- Stabilizer spring balances cutting forces and offers more control of the tool when drilling drywall.
- Dedicated arbor and pilot drill eliminates changeover time.
- Fits a 3/8" drill chuck and can be used with a cordless drill.
- Included dust shield helps eliminate flying dust and debris.



CAT. NO.	UPC NO.	DESCRIPTION
06923	06923	Quick Cutter Recessed Hole Saw, Adjustable in 1/2" Increments for Cuts of 2-1/2" to 7"

Recommended Hole Saw Cutting Speeds

HOLE SAW SIZE		RPM			
INCH	mm	MILD STEEL	CAST IRON	BRASS	ALUMINUM
9/16	14.3	580	400	790	900
5/8	15.9	550	365	730	825
11/16	17.5	500	330	665	750
3/4	19.0	460	300	600	690
13/16	20.6	425	280	560	635
7/8	22.2	390	260	520	585
15/16	23.8	370	245	495	555
1	25.4	350	235	470	525
1-1/16	27.0	325	215	435	480
1-1/8	28.6	300	200	400	450
1-3/16	30.2	285	190	380	425
1-1/4	31.7	275	180	360	410
1-5/16	33.3	260	175	345	390
1-3/8	35.0	250	165	330	375
1-7/16	36.5	240	160	315	360
1-1/2	38.1	230	150	300	345
1-9/16	39.7	220	145	290	330
1-5/8	41.3	210	140	280	315
1-11/16	42.9	205	135	270	305
1-3/4	44.4	195	130	260	295
1-13/16	46.0	190	125	250	285
1-7/8	47.6	180	120	240	270
2	50.8	170	115	230	255
2-1/16	52.4	165	110	220	245
2-1/8	54.0	160	105	210	240
2-1/4	57.2	150	100	200	225

HOLE SAW SIZE		RPM			
INCH	mm	MILD STEEL	CAST IRON	BRASS	ALUMINUM
2-5/16	58.7	150	100	195	225
2-3/8	60.3	140	95	190	200
2-1/2	63.5	135	90	180	205
2-9/16	65.0	130	85	175	200
2-5/8	66.7	130	85	170	195
2.677	68.0	125	80	160	185
2-3/4	69.8	125	80	160	185
2-7/8	73.0	120	80	160	180
2.913	74.0	115	75	150	170
3	76.2	115	75	150	170
3-1/8	79.4	110	70	140	165
3-1/4	82.5	105	70	140	155
3-3/8	85.7	100	65	130	150
3-1/2	88.9	95	65	130	145
3-5/8	92.1	95	60	120	140
3-3/4	95.2	90	60	120	135
3-7/8	98.4	90	60	120	135
4	101.6	85	55	110	130
4-1/8	104.8	80	55	110	120
4-1/4	108.0	80	55	110	120
4-3/8	111.1	80	50	100	120
4-1/2	114.3	75	50	100	105
4-3/4	120.6	75	50	95	95
5	127.0	65	45	90	90
5-1/2	139.7	60	35	85	85
6	152.4	55	35	75	75

Holemaking

USA Tel: 800.435.0786
Fax: 800.451.2632

Canada Tel: 800.435.0786
Fax: 800.524.2853

International Tel: +1.815.397.7070
Fax: +1.815.397.9247

SAW BLADES

Reciprocating Blades

- Progressive-pitch reciprocating saw blades cut a wide range of standard construction materials quickly and cleanly – regardless of thickness.
- Bi-metal construction provides maximum flexibility and break resistance – plus lasting sharpness.
- Exclusive plunge tip makes starting cuts faster and easier.
- Blades color coded by application.



16-gauge metal stud



EMT conduit



strut



















thick wall pipe



rod/rebar

RECIPROCATING SAW BLADES

	CAT. NO.	UPC NO.	LENGTH x WIDTH x THICKNESS		TEETH PER INCH	TYPE	APPLICATION	QTY. PER PK.
			INCHES	mm				
Metal								
	353-123	09963	6 x 3/4 x .035	152 x 19.05 x .889	Progressive	Bimetal, Straight	Metal	5
	353-318	09961	4 x 5/16 x .035	101 x 7.938 x .889	18	Bimetal, Scroll	Metal	5
	353-418	09962	4 x 3/4 x .035	101 x 19.05 x .889	18	Bimetal, Straight	Metal	5
	353-614	09964	6 x 3/4 x .035	152 x 19.05 x .889	14	Bimetal, Straight	Metal	5
	353-618	09965	6 x 3/4 x .035	152 x 19.05 x .889	18	Bimetal, Straight	Metal	5
	353-624	09966	6 x 3/4 x .035	152 x 19.05 x .889	24	Bimetal, Straight	Metal	5
	353-804	09977	8 x 3/4 x .050	203 x 19.05 x 1.27	10/14	Bimetal, Straight	Metal	2
	353-814	09975	8 x 3/4 x .050	203 x 19.05 x 1.27	14	Bimetal, Straight	Metal	2
	353-818	09976	8 x 3/4 x .050	203 x 19.05 x 1.27	18	Bimetal, Straight	Metal	2
Wood								
	353-234	09991	8 x 3/4 x .050	203 x 19.05 x 1.27	Progressive	HCS, Taper	Wood Only	5
	353-656	09967	6 x 3/4 x .050	152 x 19.05 x 1.27	6	Bimetal, Taper	Wood with Nails	5
	353-646	09968	6 x 3/4 x .050	152 x 19.05 x 1.27	6	Bimetal, Straight	Wood with Nails	5
	353-956	09969	9 x 3/4 x .050	228 x 19.05 x 1.27	6	Bimetal, Straight	Wood with Nails	5
	353-156	09970	12 x 3/4 x .050	304 x 19.05 x 1.2	6	Bimetal, Straight	Wood with Nails	5
Demolition								
	353-966	09979	9 x 7/8 x .062	228 x 22.23 x 1.56	6	Bimetal, Taper	Wood Demolition	2
	353-969	09990	9 x 7/8 x .062	228 x 22.23 x 1.56	8/10	Bimetal, Taper	Metal Demolition	2
Specialty								
	353-345	09972	8 x 3/4 x .050	203 x 19.05 x 1.27	Progressive	Bimetal, Taper	General	5

Jig Saw Blades



- Progressive-tooth design delivers faster cutting through a broad range of material types and thicknesses.
- Shatterproof bi-metal construction with high speed cobalt matrix cutting edge.
- For rough and finish cutting in full range of applications including wood (even with nails), metal, plaster, drywall and fiberglass.
- Tungsten Carbide Grit Edge blade style.
 - No teeth to snag, cuts efficiently on both up and down strokes for extra smooth finishes.
 - Additional cutting application for cast iron, tile, pipe, ceramic.
- Center front tooth makes plunge cuts quick and easy.

JIG SAW BLADES

CAT. NO.	UPC NO.	DESCRIPTION	TEETH	TYPE	APPLICATION	TEETH PER INCH	QTY. PER PK.
373-U123	09994	3-5/8" Universal Jig Saw Blade	Progressive	High-speed Steel	Metal	18	5
373-U234	09993	4-1/4" Universal Jig Saw Blade	Progressive	High-carbon Steel	Wood	6	3
373-U345	09995	5" Universal Jig Saw Blade	Progressive	Bimetal	General	18	5
373-U300	09996	2-3/4" Universal Jig Saw Blade	Grit	Carbide Grit	Abrasive Materials	18	2
373-UVAR	09997	Universal Jig Saw Blade – Variety Pack	Progressive	373-U123 373-U234 373-U345	Metal, Wood and General	6	1 ea.
373-T123	10004	4" T-Shank Jig Saw Blade	Progressive	High-speed Steel	Metal	18	3
373-T234	10003	4-1/2" T-Shank Jig Saw Blade	Progressive	High-carbon Steel	Wood	6	5
373-T345	10005	5-1/4" T-Shank Jig Saw Blade	Progressive	Bimetal	General	18	5
373-TVAR	10006	T-Shank Jig Saw Blade – Variety Pack	Progressive	373-T123 373-T234 373-T345	Metal, Wood and General	6	1 ea.

FLEXIBLE CONDUIT CUTTERS

Flex Splitter® MC and Flexible Conduit Cutter



- Cut flexible metal conduit in seconds with a few turns of the crank and an easy twist of the conduit.
- Ample clearance between handle and body for comfortable operation.
- Set conduit size for multiple cuts of the same size conduit. No need to reset.
- Compact and lightweight. Fits easily in back pocket or tool pouch.
- Set blade adjustment with only a screwdriver.
- Convenient in-handle blade storage – holds up to five spare blades.
- Point-of-purchase packaged. Blades point-of-purchase packaged 1 and 5 blades per package.

CAT. NO.	UPC NO.	DESCRIPTION
1940	34953	Flex Splitter Flexible Metal Conduit Cutter
1941-1	00288	(R) Single Blade for 1940
1941-5	33735	(R) 5 Pack Blades for 1940

SPECIFICATIONS

Capacity	14/2 to 10/4 BX 3/8" flexible metal conduit
Weight	1940 - 4 lbs. (1.8 kg)

(R) = REPLACEMENT PART (A) = ACCESSORY

HAND SAWS

12" Hack Saw

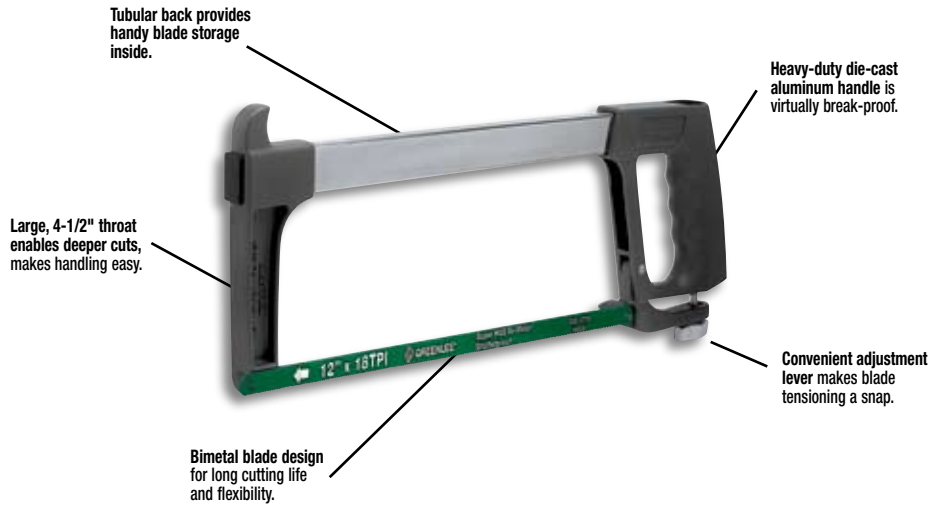

CAT. NO.	UPC NO.	DESCRIPTION
302	10047	12" (305 mm) Hack Saw Frame
333	25571	12" (305 mm) Heavy-Duty Hack Saw Frame

SPECIFICATIONS

Capacity	12" (304.8 mm) Blade
Weight	1.4 lbs. (0.7 kg)

REPLACEMENT HACK SAW BLADES

CAT. NO.	UPC NO.	DESCRIPTION	QTY. PER PK.
333-1218	10037	12" (305 mm) Bi-metal Blade, 18 Teeth Per Inch	5
333-1224	10038	12" (305 mm) Bi-metal Blade, 24 Teeth Per Inch	5
333-1232	10039	12" (305 mm) Bi-metal Blade, 32 Teeth Per Inch	5

Keyhole Saw



- Ergonomic-style handle with non-slip grip creates a sure and comfortable feel.
- Hardened steel blade makes cutting drywall, cement board, plastic and wood quick and easy.
- Blade goes through the handle for maximum support of the cutting blade.

CAT. NO.	UPC NO.	DESCRIPTION
301	01641	Keyhole Saw with 6" Blade (152 mm)

PVC Saws



- "V" tooth design enables straight cuts on both push and pull saw strokes.
- Resharpenable blade.
- Pointed blade nose makes drywall surface penetration easy.
- Ergonomic handle is interchangeable with most popular PVC saw brands.

CAT. NO.	UPC NO.	BLADE LENGTH	DESCRIPTION
322-013	00113	13" (330 mm)	PVC Saw
322-018	00114	18" (457 mm)	PVC Saw
322-113	00115	13" (330 mm)	R Blade for 00113
322-118	00116	18" (457 mm)	R Blade for 00114

BAND SAWS

Heavy-Duty Band Saw



- Cuts up to 8" pipe and 9-1/2" x 11" (241 x 280 mm) tray or duct.
- Convertible to wet cutting systems with optional accessories.
- Three sawing speeds 76, 141, and 268 feet per minute (23, 43, and 82 meters per minute).
- Converts to vertical in seconds.
- Automatic shut-off after cut is complete.
- Sturdy wheels for mobility and stability.
- Heavy-duty, adjustable hydraulic feed.
- Heavy-duty, steel bed with welded steel legs.

SPECIFICATIONS

Capacity	Rectangular 9-1/2" x 11" (241.3 x 279.4 mm) Round 9-1/2" Dia. or 8" Pipe (241.3 mm) 45° Angle 5-1/2" (139.7 x 139.7 mm) Vertical Work Table 7-5/8" x 10" (193.7 x 254.0 mm) Throat Height 9-1/2" (241.3 mm) Throat Depth 6-1/4" (158.8 mm)
Dimensions	52" H. x 47" L. x 27" W. (13208 H. x 11938 L. x 685.8 W. mm)
Power Source	1399-120 VAC 1/2 Horsepower. 1399-22 - 220 VAC
Weight	346 lbs. (157 kg)
Blade Size	1/2" x .025" x 93" (12.7 mm x 0.64 mm x 2362 mm)

CAT. NO.	UPC NO.	DESCRIPTION
1399	31961	9-1/2" x 11": Capacity Mobile Band Saw (241.3 x 279.4 mm)
1399-22	32364	9-1/2" x 11" Capacity Mobile Band Saw (241.3 x 279.4 mm) 220 VAC
32322	32322	Wet Cutting System for 120VAC 1399
32237	32237	Vertical Work Table

Band Saw Blades

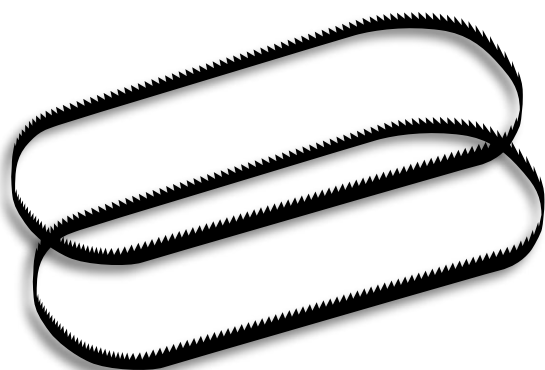

Perfect for your mobile or portable band saw, these top-quality, bi-metal blades feature high-speed steel teeth that can handle even tough metals like stainless steel with ease. Virtually unbreakable, too.

- Bi-metal blades feature high-speed tool steel, bonded to an extra-tough alloy back for maximum hardness and heat resistance.
- Fits most popular models of portable band saws.

MOBILE BAND SAW BLADES





CAT. NO.	UPC NO.	DESCRIPTION	TYPE	APPLICATION	TEETH PER INCH
399-14A	32336	1/2" x .025" x 93" Mobile Band Saw Blade ¹	Bi-metal	Metal	10/14
399-18A	32337	1/2" x .025" x 93" Mobile Band Saw Blade ¹	Bi-metal	Metal	18
399-24A	32338	1/2" x .025" x 93" Mobile Band Saw Blade ¹	Bi-metal	Metal	24
389-1014	10044	1/2" x .020" x 44-7/8" Portable Band Saw Blade ²	Bi-metal	Metal	10/14
389-1418	10045	1/2" x .020" x 44-7/8" Portable Band Saw Blade ²	Bi-metal	Metal	14/18
389-24	10043	1/2" x .020" x 44-7/8" Portable Band Saw Blade ²	Bi-metal	Metal	24

¹ Use with 1399 (31961)

² Use with 530 (30276)

ANCHORS AND FASTENERS

Anchor and Fastener Selection Guide

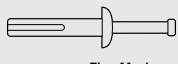
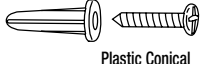
ANCHOR/FASTENER TYPE	USE IN	USE WITH	MADE OF	SIZE RANGE	GENERAL INFORMATION
 Caulking	Concrete, brick, stone, block	Machine screw or bolts	Zinc alloy and lead	1/4" - 20 to 3/8" - 16	Single unit caulking anchor, can be set shallow (flush) or deep in hole. Setting tool required (1 provided free in each box of anchors). For setting in hollow block or to set anchors all at the same depth, use Greenlee Screw anchor expander.
 Drop	Concrete, brick, stone	Machine screw or bolts	Steel	1/4" - 20 to 3/8" - 16	Heavy-duty use in solid masonry where codes require all steel bolt anchors. Pre-assembled, internal expander plug. Can be installed flush with masonry surface or sub-set. Setting tool required (1 provided free in each box of anchors).
 Masonry Screw	Concrete, block, brick	No other fastener needed	Steel	1/4" x 1" to 1/4" x 2-1/2"	A safe, secure fastener that actually taps concrete and eliminates the need for concrete inserts with their alignment problems. Use with Greenlee masonry drill set tool.
 Toggle Bolts	Block, wallboard, plaster, tile	No other fastener needed	Steel	L3/16" x 3" to 3/8" x 4"	Available in round head and mushroom head. Fully-threaded machine screw with spring wing toggle head.
 Zinc Mushroom Head	Concrete, block, brick	No other fastener needed	Zinc and Steel	1/4" x 1" to 1/4" x 1-1/2"	Fast, medium-duty. No hole spotting, removable. Use in hollow or solid base applications.
 Plastic Conical	Concrete, block, tile, brick	Sheet metal, wood, lag screws	Corrosion-resistant plastic	#6-8 x 1" to #10-12 x 1"	Light-duty, multi-size anchor. Has collar for hollow materials.

Screw Anchor Expanders for Caulking Anchors



- Quickly and securely set expansive screw anchors in masonry, regardless of thickness.
- Hardened alloy steel.
- Patented.

CAT. NO.	UPC NO.	EXPANSIVE BELT SIZE	USE WITH ANCHOR NO.	QTY. PER BOX	WEIGHT LB.	kg
866	02667	#10 - 24	84299	1	.3	.1
868	02669	1/4" - 20	84299	1	.4	.2
870	02671	3/8" - 16	84305	1	.6	.3

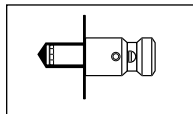

1. Drill hole of required size and put anchor screw on expander. Insert screw anchor into drilled hole.

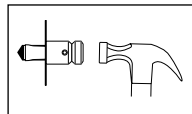

2. Strike head of expander with hammer or mallet until anchor is held securely in wall. Unscrew expander.

CAT. NO.	UPC NO.	DESCRIPTION
4451AV	05191 R	Anchor Screw for 866
4457AV	05197 R	Anchor Screw for 868
4717AV	05300 R	Anchor Screw for 870
1125GB	50423 B	Roll Pin 1/4" x 1-1/8"

Caulking Anchors

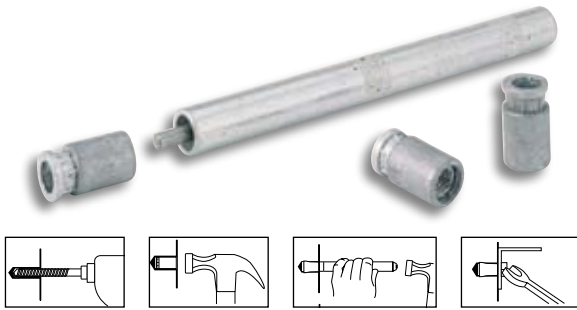

1. Drill hole in masonry.
2. Insert anchor, conical end first, until flush with surface.
3. Using setting tool, caulk lead outer sleeve with sharp blows. Position fixture.
4. Insert screw or bolt and tighten.

- Zinc alloy and lead caulking anchor can be set flush or subset. Greenlee setting tool required.
- Rustproof, use interior or exterior.
- For setting in hollow block. To set anchors all same depth, use Greenlee screw anchor expander.

LEAD CAULKING ANCHORS AND SETTING TOOLS

CAT./UPC NO.	THREAD SIZE	REQ. HOLE		SET TOOL*	QTY. PER BOX	WEIGHT		WORKING LOAD PULLOUT	
		DIA.	MIN. DEPTH			LBS.	kg	LBS.	kg
84299	1/4"-20	1/2"	7/8"	84329	100	3.8	1.7	125	56.6
84305	3/8"-16	3/4"	1-1/4"	84335	50	7.1	3.2	312.5	141.6

*One Setting Tool included with each box of anchors.

Approvals: Conforms to the description in Federal Specification FFS-325, Group I, Type 1, Class 1.

NOTE: Working load is one fourth the ultimate/maximum capacity. For critical or unusual applications, site testing is recommended.

Drop Anchors



TO SET ANCHOR FLUSH WITH SURFACES

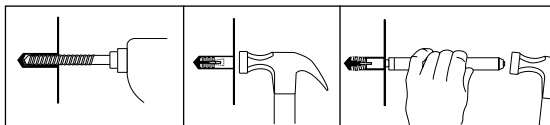

1. Drill hole the same diameter as anchor being used.
2. Drive anchor flush with concrete.
3. Expand anchor with setting tool provided. Anchor is properly expanded when shoulder of setting tool is flush with top of anchor.

TO SET ANCHOR BELOW SURFACES

1. Drill hole deeper than anchor length. Thread bolt into anchor. Hammer anchor into hole until bolt head is at desired height. Remove bolt and set anchor with setting tool.

NOTE: The use of a 24 to 40 ounce hammer is recommended for expanding the anchor.

- Heavy-duty steel anchor for use where codes require all steel bolt anchors.
- Pre-assembled, internal expander plug for faster installation.
- Four-way slot design assures firm hold.

DROP ANCHORS AND SETTING TOOLS

CAT./UPC NO.	ANCHOR & HOLE DIA.	BOLT THREAD SIZE	MIN. DEPTH	THREAD DEPTH	SETTING TOOL*	QTY. PER BOX	WEIGHT	
							LB.	kg
84253	3/8"	1/4"-20	1-1/8"	1/2"	84273	100	3	1.4
84256	1/2"	3/8"-16	1-5/8"	5/8"	84276	50	7	3.2

*One Setting Tool included with each box of anchors.

SPECIFICATIONS

CAT./UPC NO.	WORKING LOAD PULLOUT		WORKING LOAD SHEAR	
	LBS.	kg	LBS.	kg
84253	1037	469.8	842.5	381.7
84256	1712.5	775.8	1518.7	688.9

Approvals: Conforms to the description in Federal Specification FFS-325, Group VIII, Type 1, for concrete expansion shield anchors.

NOTE: Working load is one fourth the ultimate/maximum capacity.

For critical or unusual applications, site testing is recommended.

Zinc Mushroom Head Drive Anchors

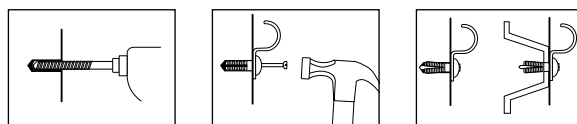

1. Drill required diameter hole in material, to a minimum depth equal the overall anchor minus the thickness of the object to be fastened. Clean hole.
2. Insert anchor body through object to be fastened, and into the hole in base material.
3. Tap the nail until it is flush with the zinc anchor head.

- Fast, medium-duty anchor for use in concrete, block and brick.
- No hole spotting.
- Use in hollow or solid material.
- Made of zinc and steel.

CAT./UPC NO.	SIZE	REQUIRED HOLE SIZE	QTY PER BOX	WEIGHT	
				LBS.	kg
84110	1/4" x 1"	1/4"	100	2	.9
84111	1/4" x 1-1/4"	1/4"	100	2.4	1.1
84112	1/4" x 1-1/2"	1/4"	100	2.6	1.2

NOTE: For critical or unusual applications, site testing is recommended.

Plastic Conical Anchors

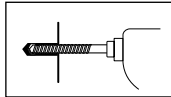
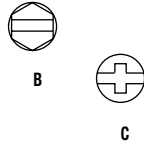

1. Drill hole full length of anchor or 1/8" deeper.

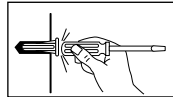

2. Tap anchor into hole flush with surface.

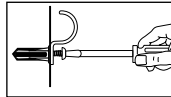

3. Insert screw through fixture into plastic plug and tighten.

- Light-duty, multi-size anchor for use in concrete, block, tile and brick.
- Use with sheet metal, wood and lag screws.
- Has collar for hollow materials.
- Moisture and chemical resistant, for indoor/outdoor use.
- Anchor kits include 100 anchors, 100 screws and one masonry bit.

ANCHORS ONLY

CAT./ UPC NO.	USE WITH SCREW SIZES	REQUIRED HOLE SIZE	QTY. PER BOX	WEIGHT	
				LBS.	kg
84003	#6 - #8	3/16"	100	.2	.1
84006	#10, #12	1/4"	100	.2	.1

ANCHOR KITS

CAT./ UPC NO.	ANCHOR SIZE	SCREW		BIT SIZE	WEIGHT	
		SIZE	TYPE		LBS.	kg
84009	#6, #8	#8 x 1"	C	3/16"	.8	.4
84012	#10, #12	#10 x 1"	C	1/4"	1	.5
84015	#10, #12	#12 x 1"	C	1/4"	1.4	.6
84019	#10, #12	#10 x 1"	B	1/4"	1.1	.5

Masonry Screw Anchors



Masonry Screw Anchors must be used with Greenlee masonry screw drill bits, numbers 84484 and 84487, which are a special size to insure secure thread engagement. Standard masonry bit size holes will not provide proper contact with screw threads and may cause masonry anchor screws to pull out.

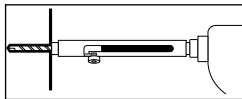

1. Use set Tool with bit in drilling position to drill hole in surface.

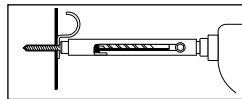

2. Retract bit, insert masonry screw into socket head of tool and drive screw into hole.

- A safe, secure, steel fastener that taps concrete and eliminates the need for concrete inserts with their alignment problems.
- Use with Greenlee masonry drill set tool.
- Use in concrete, block and brick.
- Quick and easy two-step installation, saves time.
- Made in USA.

MASONRY SCREW ANCHORS – EACH BOX OF 100 INCLUDES 1 BIT

CAT./ UPC NO.	SIZE	MATERIAL CONCRETE 3000 PSI		QTY. PER BOX	WT.	
		MIN. EMBEDMENT	PULLOUT LBS.		LBS.	kg
84469	1/4" x 1"	3/4"	1180	100	1.2	.5
84472	1/4" x 1-1/4"	3/4"	1180	100	1.4	.6
84475	1/4" x 1-1/2"	1-1/4"	1800	100	1.6	.7
84478	1/4" x 2"	1-1/4"	1800	100	1.8	.8
84481	1/4" x 2-1/2"	1-1/4"	1800	100	2.1	1.0

INSTALLATION TOOLS

CAT./ UPC NO.	DESCRIPTION	QTY. PER BOX	WT.	
			LBS.	kg
84466	Masonry Screw Drill Set Tool with 84484 Bit	1	.4	.2
84484	3-1/2" Masonry Screw Drill Bit – for use with 1" to 1-1/2" long screws	1		

NOTE: For use in lightweight, hollow core concrete block, minimum embedment 1-3/8", pullout 715 lbs. Due to the variance in make-up of cement block, values will vary. It is suggested that the anchor be tested in specific material being used before installing fixtures.

MASONRY SCREW DRILL SET KIT

CAT./ UPC NO.	DESCRIPTION	MATERIAL CONCRETE 3000 PSI		QTY. PER BOX	WT.	
		MIN. EMBEDMENT	PULLOUT LBS.		LBS.	kg
84463	Masonry Screw Drill Set Kit Includes:	3/4"	1180	1	1.6	.7
84469	50 – 1/4" x 1" Masonry Screws					
84472	50 – 1/4" x 1-1/4" Masonry Screws					
84466	1 – Masonry Screw Drill Set Tool with 84484 Bit					

Small Jobs – Use special Greenlee masonry screw drill bit for holes. Screw can be installed with 5/16" wrench, nut driver or socket with ratchet.

Large Jobs – Use the special Greenlee Masonry Screw Drill Set Tool in kit with 3/8" or larger electric drill for drilling holes and screw installation.

Toggle Bolts and Spring Wings



- For light to medium fastening in block, wallboard, plaster and hollow tile.
- Fully threaded machine screw with spring wing toggle head.
- Generous size of toggle head acts to spread the load over a maximum area.

TOGGLE BOLTS AND SPRING WINGS

CAT./ UPC NO.	TOGGLE BOLT		REQUIRED HOLE SIZE	QTY. PER BOX	WEIGHT	
	SIZE	HEAD			LBS.	kg
84405	1/4" x 4"	Round	11/16"	50	3.7	1.7
84409	3/8" x 4"	Round	1"	25	4.3	1.9
84424	3/16" x 3"	Mushroom	1/2"	50	1.9	.9
84425	3/16" x 4"	Mushroom	1/2"	50	2.2	1.0
84428	1/4" x 3"	Mushroom	11/16"	50	3.3	1.5
84429	1/4" x 4"	Mushroom	11/16"	50	3.8	1.7

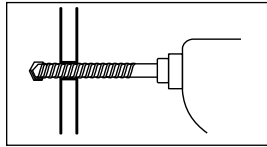

1. Drill hole completely through wall.

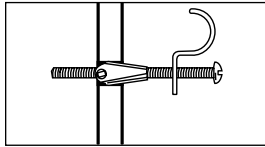

2. Insert bolt through items to be fastened. Fold wings completely back, then push through hole until wings spring open.

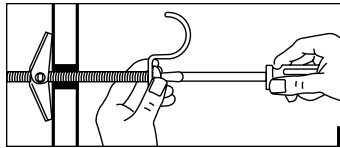

3. Pull back to hold wings against inside wall while tightening with screw driver.

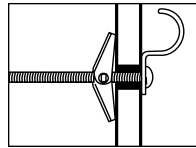

MASONRY BITS

Masonry Bits



Fast Spiral



Percussion

SPECIFICATIONS

Twist Length	2-1/2" (63 mm)
Overall Length	4" (101 mm)

- Steel bit with carbide tip.
- Use in concrete, block, brick, stone, wallboard and plaster.
- Available in two styles: percussion for use in electric hammer and fast spiral for use in conventional power drills.
- Available in sizes ranging from 3/16" - 1/2" (4.8 - 12.7 mm)

PERCUSSION BITS

CAT./ UPC NO.	HOLE DIA.		SHANK		WEIGHT	
	INCH	mm	INCH	mm	LBS.	g
84576	3/16	4.8	3/16	4.8	.03	14
84582	1/4	6.4	1/4	6.4	.05	23
84588	5/16	7.9	1/4	6.4	.06	27
84594	3/8	9.5	1/4	6.4	.08	36
84600	1/2	12.7	1/4	6.4	.12	54

FAST SPIRAL BITS

CAT./ UPC NO.	HOLE DIA.		SHANK		WEIGHT	
	INCH	mm	INCH	mm	LBS.	g
84526	3/16	4.8	3/16	4.8	.03	14
84532	1/4	6.4	1/4	6.4	.05	23
84538	5/16	7.9	1/4	6.4	.06	27
84544	3/8	9.5	1/4	6.4	.08	36
84550	1/2	12.7	1/4	6.4	.12	54

TAPCON® Masonry Fasteners and Drill Bits

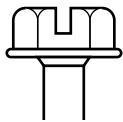
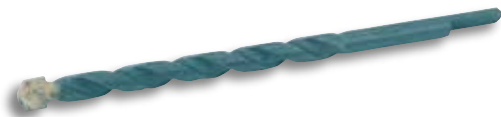

A
Slotted Hex
Washer Head

- Corrosion-resistant – All Tapcon fasteners are protected against rust and corrosion by the exclusive Stalgard® finish.
- Fast – install two or three Tapcon fasteners per minute. Simple two-step operation – drill, then drive – eliminates the need to set anchors.
- Strong – Tapcon fasteners and the masonry material are mechanically linked for exceptionally strong pullout strength.
- Removable – Tapcon fasteners can be removed and reinserted in the same hole. Great for repairs or adjustments.
- Available in two diameters – 1/4" and 3/16".
- Made in USA.

TAPCON® MASONRY FASTENERS – EACH BOX OF 100 INCLUDES 1 BIT

CAT. NO.	UPC NO.	FASTENER		EMBEDMENT		MAXIMUM ATTACHMENT THICKNESS	QTY. PER BOX
		SIZE	TYPE	MIN.	MAX.		
LE 405	07405	1/4" x 1-1/4"	A	1"	1-3/4"	1/4"	100
LE 415	07415	1/4" x 1-3/4"	A	1"	1-3/4"	3/4"	100
LE 425	07425	1/4" x 2-1/4"	A	1"	1-3/4"	1-1/4"	100
LE 435	07435	1/4" x 2-3/4"	A	1"	1-3/4"	1-3/4"	100
LE 445	07445	1/4" x 3-1/4"	A	1"	1-3/4"	2-1/4"	100
LE 455	07455	1/4" x 3-3/4"	A	1"	1-3/4"	2-3/4"	100
LE 300	07300	3/16" x 1-1/4"	A	1"	1-3/4"	1/4"	100
LE 310	07310	3/16" x 1-3/4"	A	1"	1-3/4"	3/4"	100
LE 320	07320	3/16" x 2-1/4"	A	1"	1-3/4"	1-1/4"	100

Multi-Purpose Installation Tool



- Multi-purpose tool designed to be used with all sizes and styles of Tapcon® masonry fasteners.
- Tapcon anchors are easy to install... a simple, two-step operation – drill the hole, then drive the fastener with the Condriive tool.

CAT. NO.	UPC NO.	DESCRIPTION
LP 100	07100	Condriive 1000 kit consists of: Drill Adapter, Drill Sleeve Assembly, 5/16" Hex Driver-Magnetic, 1/4" Hex Socket for 3/16" Anchor, Phillips Bit, #2 Phillips Bit, #3 Phillips Bit, 1/8" Hex Key, Set Screw 1/4-28, Drive Sleeve Assembly for 5" & 6" Anchors

High-Speed Installation Tool



- Convenient one-step tool designed for high speed installation of Tapcon fasteners.
- Best for rapid, repetitive drilling and fastener installation.
- Specifically designed for hex head Tapcon fasteners in lengths up to 2-3/4".

CAT. NO.	UPC NO.	DESCRIPTION
LP 200	07200	Condriive 2000 kit consists of: Tool Body/Drive Assembly, 5/16" Hex Socket for 1/4" Anchors, 1/4" Hex Socket for 3/16" Anchors, 1/8" Hex Key, 1/4" Hex Key, 5/16" Hex Key, Set Screw

Holemaking

USA Tel: 800.435.0786
Fax: 800.451.2632

Canada Tel: 800.435.0786
Fax: 800.524.2853

International Tel: +1.815.397.7070
Fax: +1.815.397.9247

