

# TLE202x, TLE202xA, TLE202xB, TLE202xY EXCALIBUR HIGH-SPEED LOW-POWER PRECISION OPERATIONAL AMPLIFIERS

SLOS191C – FEBRUARY 1997 – REVISED APRIL 2007

- Supply Current . . . 300  $\mu$ A Max
- High Unity-Gain Bandwidth . . . 2 MHz Typ
- High Slew Rate . . . 0.45 V/ $\mu$ s Min
- Supply-Current Change Over Military Temp Range . . . 10  $\mu$ A Typ at  $V_{CC} \pm = \pm 15$  V
- Specified for Both 5-V Single-Supply and  $\pm 15$ -V Operation
- Phase-Reversal Protection
- High Open-Loop Gain . . . 6.5 V/ $\mu$ V (136 dB) Typ
- Low Offset Voltage . . . 100  $\mu$ V Max
- Offset Voltage Drift With Time 0.005  $\mu$ V/mo Typ
- Low Input Bias Current . . . 50 nA Max
- Low Noise Voltage . . . 19 nV/ $\sqrt{\text{Hz}}$  Typ

## description

The TLE202x, TLE202xA, and TLE202xB devices are precision, high-speed, low-power operational amplifiers using a new Texas Instruments Excalibur process. These devices combine the best features of the OP21 with highly improved slew rate and unity-gain bandwidth.

The complementary bipolar Excalibur process utilizes isolated vertical pnp transistors that yield dramatic improvement in unity-gain bandwidth and slew rate over similar devices.

The addition of a bias circuit in conjunction with this process results in extremely stable parameters with both time and temperature. This means that a precision device remains a precision device even with changes in temperature and over years of use.

This combination of excellent dc performance with a common-mode input voltage range that includes the negative rail makes these devices the ideal choice for low-level signal conditioning applications in either single-supply or split-supply configurations. In addition, these devices offer phase-reversal protection circuitry that eliminates an unexpected change in output states when one of the inputs goes below the negative supply rail.

A variety of available options includes small-outline and chip-carrier versions for high-density systems applications.

The C-suffix devices are characterized for operation from 0°C to 70°C. The I-suffix devices are characterized for operation from –40°C to 85°C. The M-suffix devices are characterized for operation over the full military temperature range of –55°C to 125°C.



Please be aware that an important notice concerning availability, standard warranty, and use in critical applications of Texas Instruments semiconductor products and disclaimers thereto appears at the end of this data sheet.

All trademarks are the property of their respective owners.

PRODUCTION DATA information is current as of publication date. Products conform to specifications per the terms of Texas Instruments standard warranty. Production processing does not necessarily include testing of all parameters.



POST OFFICE BOX 655303 • DALLAS, TEXAS 75265

Copyright © 1997–2007, Texas Instruments Incorporated

# TLE202x, TLE202xA, TLE202xB, TLE202xY EXCALIBUR HIGH-SPEED LOW-POWER PRECISION OPERATIONAL AMPLIFIERS

SLOS191C – FEBRUARY 1997 – REVISED APRIL 2007

## TLE2021 AVAILABLE OPTIONS

T <sub>A</sub>	V <sub>IO</sub> max AT 25°C	PACKAGED DEVICES						CHIP FORM§ (Y)
		SMALL OUTLINE† (D)	SSOP‡ (DB)	CHIP CARRIER (FK)	CERAMIC DIP (JG)	PLASTIC DIP (P)	TSSOP‡ (PW)	
0°C to 70°C	200 µV 500 µV	TLE2021ACD TLE2021CD	TLE2021CDBLE	—	—	TLE2021ACP TLE2021CP	— TLE2021CPWLE	— TLE2021Y
–40°C to 85°C	200 µV 500 µV	TLE2021AID TLE2021ID	—	—	—	TLE2021AIP TLE2021IP	—	—
–55°C to 125°C	100 µV 200 µV 500 µV	— TLE2021AMD TLE2021MD	—	TLE2021BMFK TLE2021AMFK TLE2021MFK	TLE2021BMJG TLE2021AMJG TLE2021MJG	— TLE2021AMP TLE2021MP	—	—

† The D packages are available taped and reeled. To order a taped and reeled part, add the suffix R (e.g., TLE2021CDR).

‡ The DB and PW packages are only available left-end taped and reeled.

§ Chip forms are tested at 25°C only.

## TLE2022 AVAILABLE OPTIONS

T <sub>A</sub>	V <sub>IO</sub> max AT 25°C	PACKAGED DEVICES						CHIP FORM§ (Y)
		SMALL OUTLINE† (D)	SSOP‡ (DB)	CHIP CARRIER (FK)	CERAMIC DIP (JG)	PLASTIC DIP (P)	TSSOP‡ (PW)	
0°C to 70°C	150 µV 300 µV 500 µV	TLE2022BCD TLE2022ACD TLE2022CD	— — TLE2022CDBLE	—	—	— TLE2022ACP TLE2022CP	— — TLE2022CPWLE	— — TLE2022Y
–40°C to 85°C	150 µV 300 µV 500 µV	TLE2022BID TLE2022AID TLE2022ID	—	—	—	— TLE2022AIP TLE2022IP	—	—
–55°C to 125°C	150 µV 300 µV 500 µV	— TLE2022AMD TLE2022MD	—	— TLE2022AMFK TLE2022MFK	TLE2022BMJG TLE2022AMJG TLE2022MJG	— TLE2022AMP TLE2022MP	—	—

† The D packages are available taped and reeled. To order a taped and reeled part, add the suffix R (e.g., TLE2022CDR).

‡ The DB and PW packages are only available left-end taped and reeled.

§ Chip forms are tested at 25°C only.

## TLE2024 AVAILABLE OPTIONS

T <sub>A</sub>	V <sub>IO</sub> max AT 25°C	PACKAGED DEVICES				CHIP FORM§ (Y)
		SMALL OUTLINE (DW)	CHIP CARRIER (FK)	CERAMIC DIP (J)	PLASTIC DIP (N)	
0°C to 70°C	500 µV 750 µV 1000 µV	TLE2024BCDW TLE2024ACDW TLE2024CDW	—	—	TLE2024BCN TLE2024ACN TLE2024CN	— — TLE2024Y
–40°C to 85°C	500 µV 750 µV 1000 µV	TLE2024BIDW TLE2024AIDW TLE2024IDW	—	—	TLE2024BIN TLE2024AIN TLE2024IN	—
–55°C to 125°C	500 µV 750 µV 1000 µV	TLE2024BMDW TLE2024AMDW TLE2024MDW	TLE2024BMFK TLE2024AMFK TLE2024MFK	TLE2024BMJ TLE2024AMJ TLE2024MJ	TLE2024BMN TLE2024AMN TLE2024MN	—

§ Chip forms are tested at 25°C only.



# TLE202x, TLE202xA, TLE202xB, TLE202xY EXCALIBUR HIGH-SPEED LOW-POWER PRECISION OPERATIONAL AMPLIFIERS

SLOS191C – FEBRUARY 1997 – REVISED APRIL 2007

**TLE2021**  
D, DB, JG, P, OR PW PACKAGE  
(TOP VIEW)

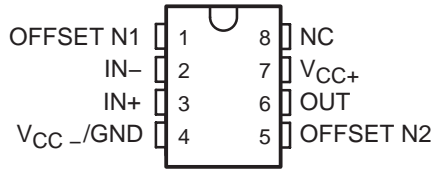

NC – No internal connection

**TLE2021**  
FK PACKAGE  
(TOP VIEW)

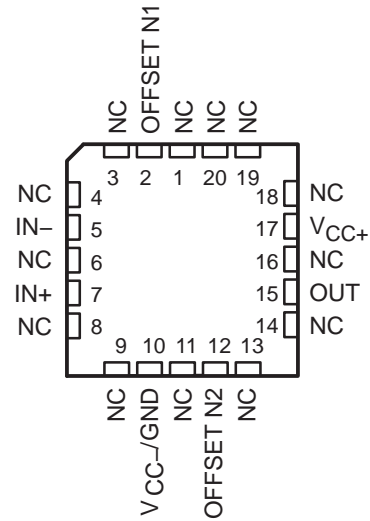

**D, DB, JG, P, OR PW PACKAGE**  
(TOP VIEW)

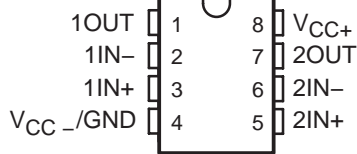

NC – No internal connection

**FK PACKAGE**  
(TOP VIEW)

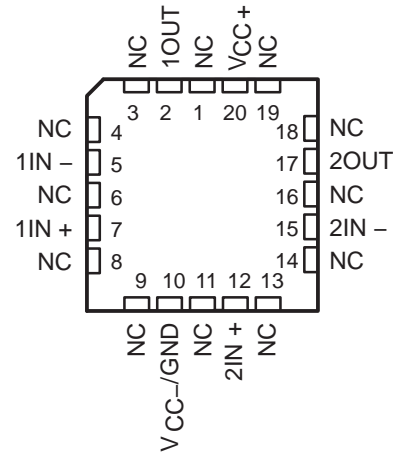

**DW PACKAGE**  
(TOP VIEW)

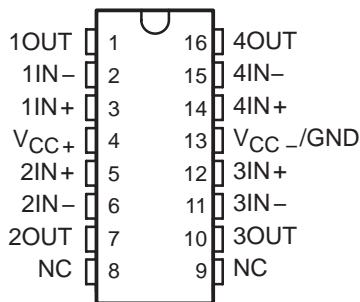

NC – No internal connection

**FK PACKAGE**  
(TOP VIEW)

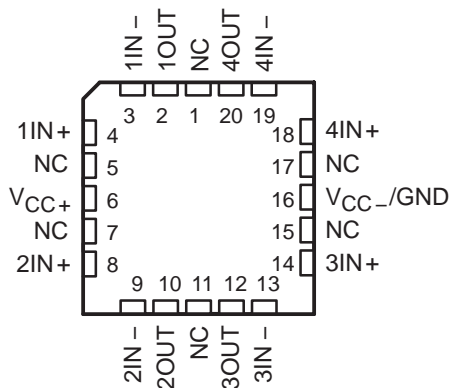

**J OR N PACKAGE**  
(TOP VIEW)

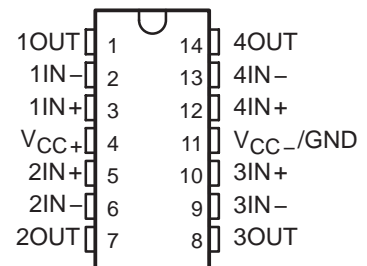

# TLE202x, TLE202xA, TLE202xB, TLE202xY EXCALIBUR HIGH-SPEED LOW-POWER PRECISION OPERATIONAL AMPLIFIERS

SLOS191C – FEBRUARY 1997 – REVISED APRIL 2007

## TLE2021Y chip information

This chip, when properly assembled, display characteristics similar to the TLE2021. Thermal compression or ultrasonic bonding may be used on the doped-aluminum bonding pads. This chip may be mounted with conductive epoxy or a gold-silicon preform.

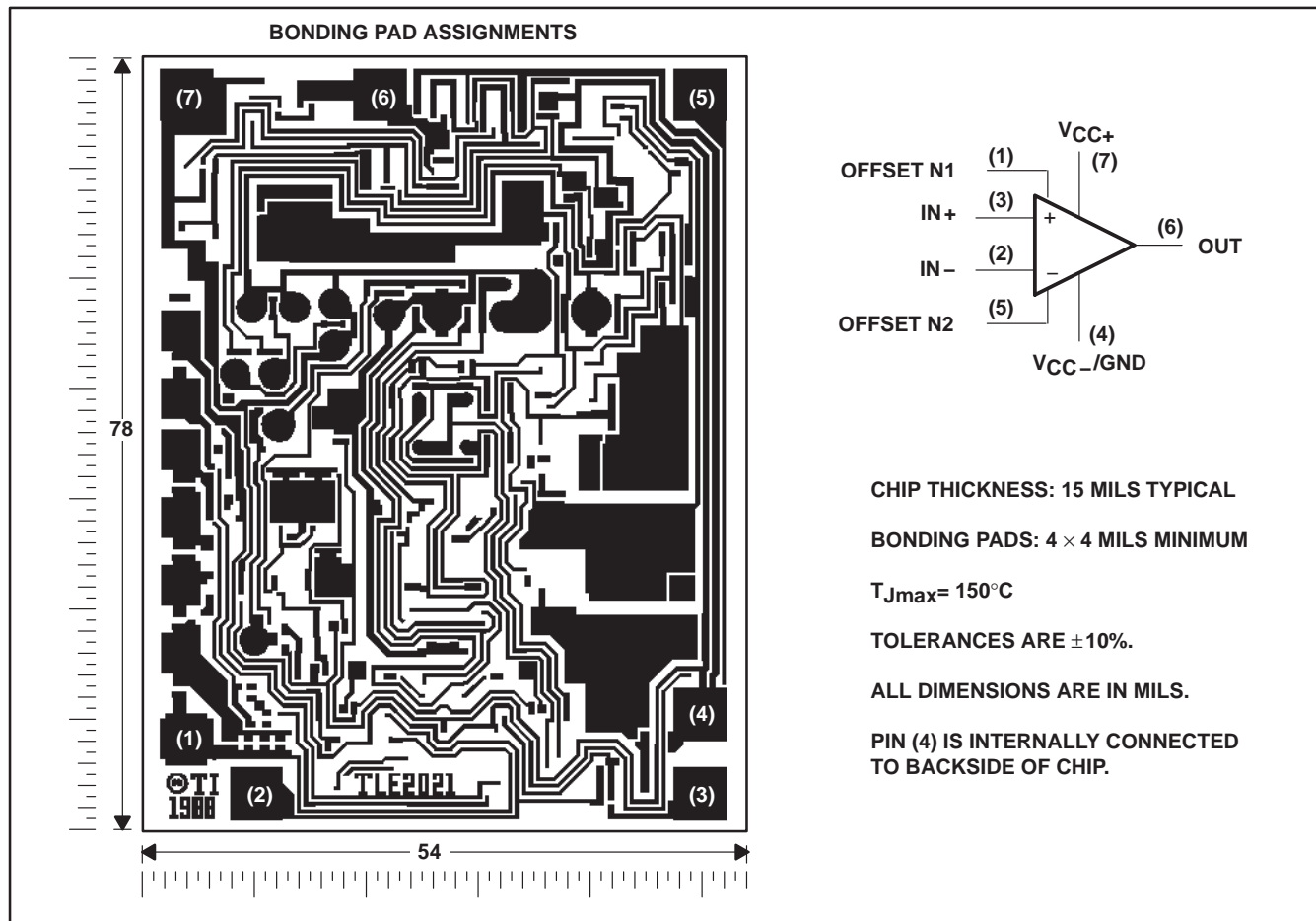

# TLE202x, TLE202xA, TLE202xB, TLE202xY EXCALIBUR HIGH-SPEED LOW-POWER PRECISION OPERATIONAL AMPLIFIERS

SLOS191C – FEBRUARY 1997 – REVISED APRIL 2007

## TLE2022Y chip information

This chip, when properly assembled, displays characteristics similar to TLE2022. Thermal compression or ultrasonic bonding may be used on the doped-aluminum bonding pads. This chip may be mounted with conductive epoxy or a gold-silicon preform.

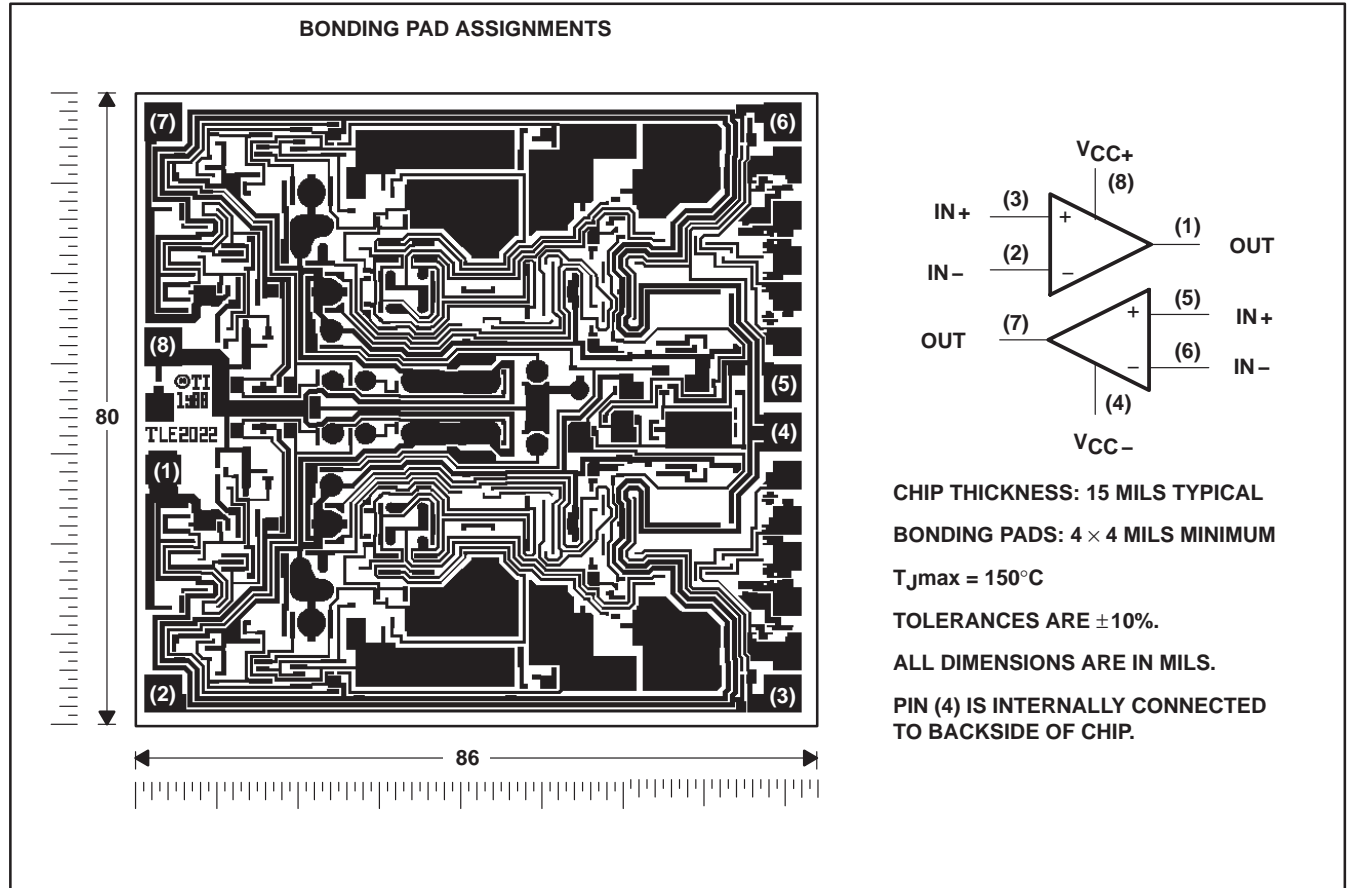

# TLE202x, TLE202xA, TLE202xB, TLE202xY EXCALIBUR HIGH-SPEED LOW-POWER PRECISION OPERATIONAL AMPLIFIERS

SLOS191C – FEBRUARY 1997 – REVISED APRIL 2007

## TLE2024Y chip information

This chip, when properly assembled, displays characteristics similar to the TLE2024. Thermal compression or ultrasonic bonding may be used on the doped aluminum-bonding pads. This chip may be mounted with conductive epoxy or a gold-silicon preform.

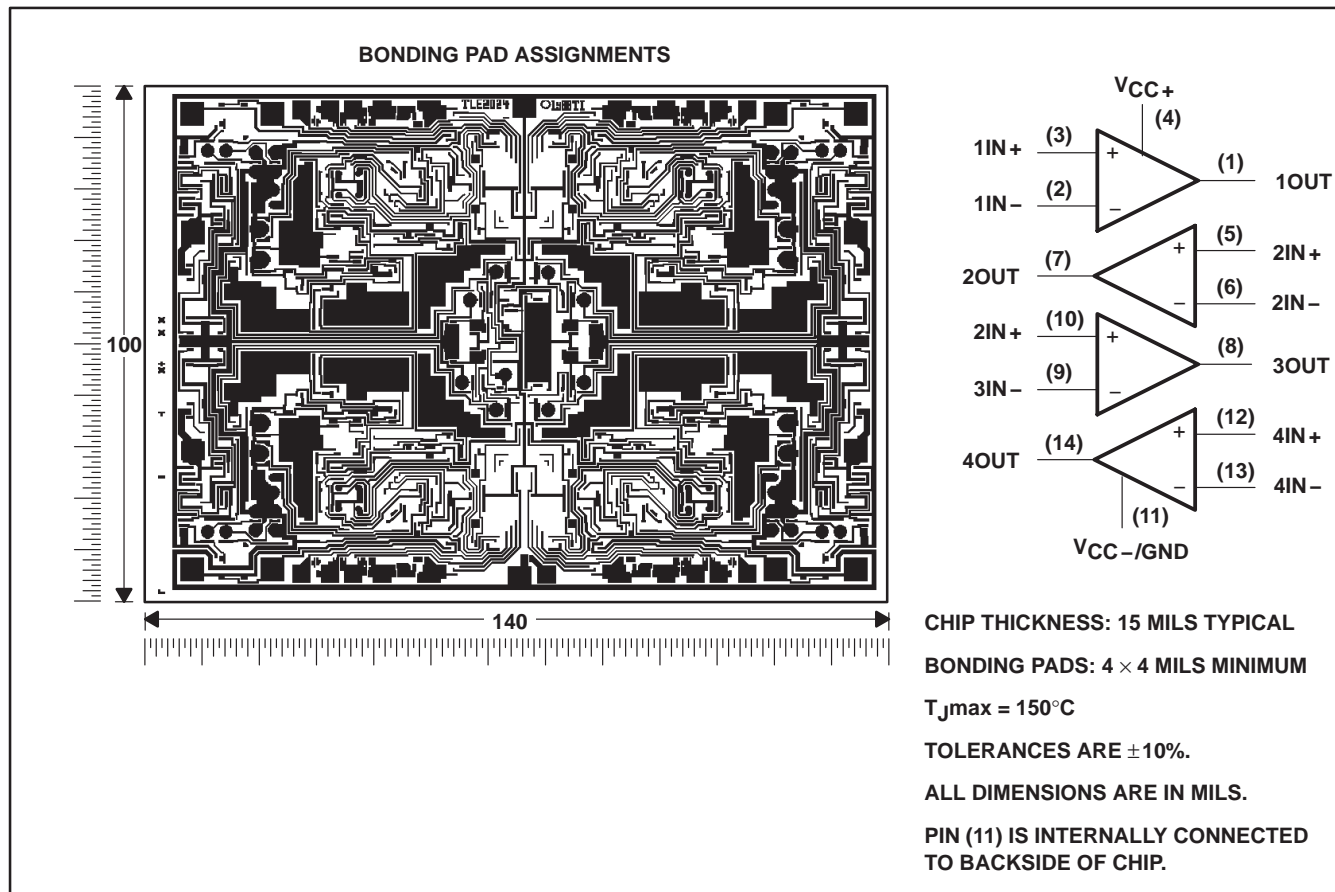

# TLE202x, TLE202xA, TLE202xB, TLE202xY EXCALIBUR HIGH-SPEED LOW-POWER PRECISION OPERATIONAL AMPLIFIERS

SLOS191C – FEBRUARY 1997 – REVISED APRIL 2007

equivalent schematic (each amplifier)

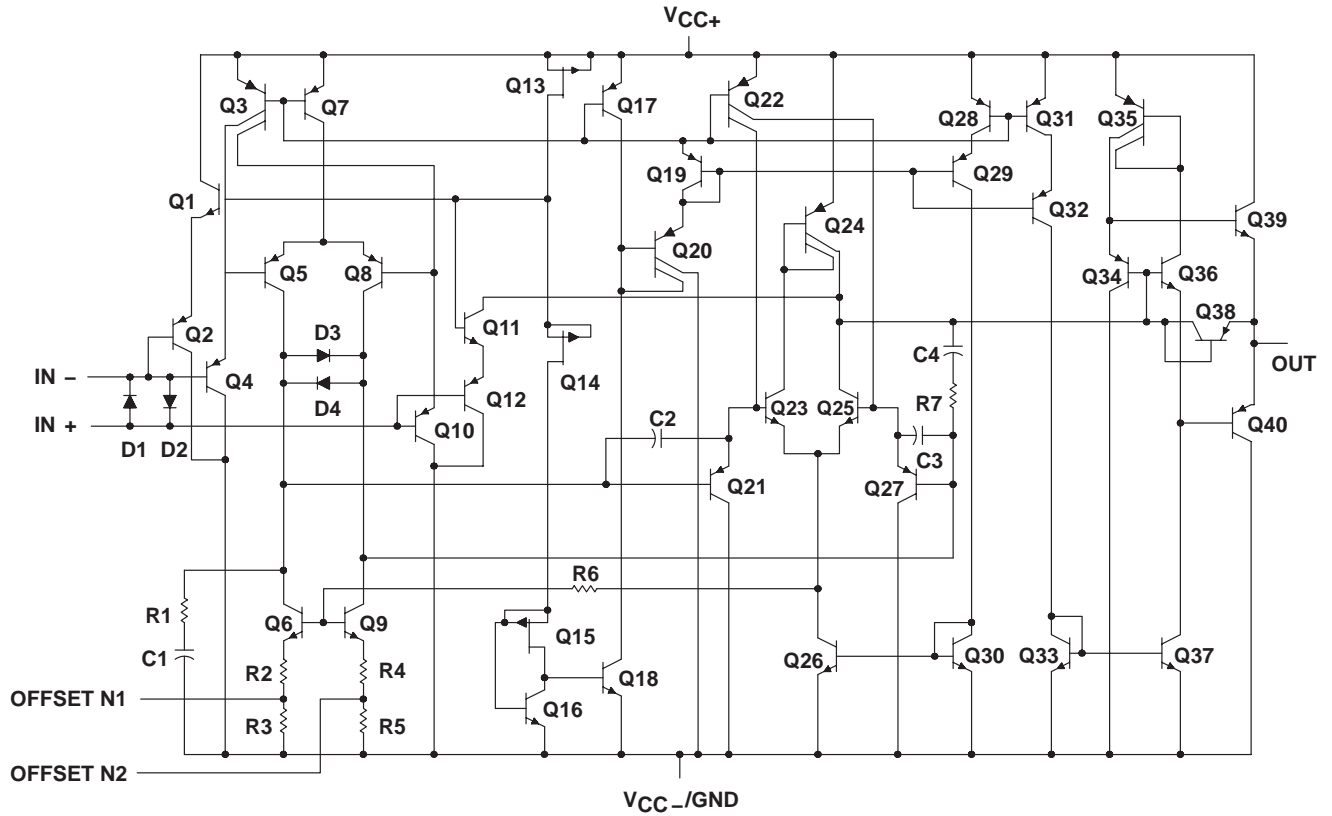

ACTUAL DEVICE COMPONENT COUNT			
COMPONENT	TLE2021	TLE2022	TLE2024
Transistors	40	80	160
Resistors	7	14	28
Diodes	4	8	16
Capacitors	4	8	16

# TLE202x, TLE202xA, TLE202xB, TLE202xY EXCALIBUR HIGH-SPEED LOW-POWER PRECISION OPERATIONAL AMPLIFIERS

SLOS191C – FEBRUARY 1997 – REVISED APRIL 2007

## absolute maximum ratings over operating free-air temperature range (unless otherwise noted)†

Supply voltage, $V_{CC+}$ (see Note 1)	20 V
Supply voltage, $V_{CC-}$ (see Note 1)	-20 V
Differential input voltage, $V_{ID}$ (see Note 2)	$\pm 0.6$ V
Input voltage range, $V_I$ (any input, see Note 1)	$\pm V_{CC}$
Input current, $I_I$ (each input)	$\pm 1$ mA
Output current, $I_O$ (each output): TLE2021	$\pm 20$ mA
TLE2022	$\pm 30$ mA
TLE2024	$\pm 40$ mA
Total current into $V_{CC+}$	80 mA
Total current out of $V_{CC-}$	80 mA
Duration of short-circuit current at (or below) 25°C (see Note 3)	unlimited
Continuous total power dissipation	See Dissipation Rating Table
Operating free-air temperature range, $T_A$ : C suffix	0°C to 70°C
I suffix	-40°C to 85°C
M suffix	-55°C to 125°C
Storage temperature range, $T_{stg}$	-65°C to 150°C
Case temperature for 60 seconds, $T_C$ : FK package	260°C
Lead temperature 1,6 mm (1/16 inch) from case for 10 seconds: D, DP, P, or PW package	260°C
Lead temperature 1,6 mm (1/16 inch) from case for 60 seconds: JG package	300°C

† Stresses beyond those listed under “absolute maximum ratings” may cause permanent damage to the device. These are stress ratings only, and functional operation of the device at these or any other conditions beyond those indicated under “recommended operating conditions” is not implied. Exposure to absolute-maximum-rated conditions for extended periods may affect device reliability.

- NOTES:
- All voltage values, except differential voltages, are with respect to the midpoint between  $V_{CC+}$ , and  $V_{CC-}$ .
  - Differential voltages are at  $IN+$  with respect to  $IN-$ . Excessive current flows if a differential input voltage in excess of approximately  $\pm 600$  mV is applied between the inputs unless some limiting resistance is used.
  - The output may be shorted to either supply. Temperature and/or supply voltages must be limited to ensure that the maximum dissipation rating is not exceeded.

DISSIPATION RATING TABLE

PACKAGE	$T_A \leq 25^\circ\text{C}$ POWER RATING	DERATING FACTOR ABOVE $T_A = 25^\circ\text{C}$	$T_A = 70^\circ\text{C}$ POWER RATING	$T_A = 85^\circ\text{C}$ POWER RATING	$T_A = 125^\circ\text{C}$ POWER RATING
D-8	725 mW	5.8 mW/°C	464 mW	377 mW	145 mW
DB-8	525 mW	4.2 mW/°C	336 mW	—	—
DW-16	1025 mW	8.2 mW/°C	656 mW	533 mW	205 mW
FK	1375 mW	11.0 mW/°C	880 mW	715 mW	275 mW
J-14	1375 mW	11.0 mW/°C	880 mW	715 mW	275 mW
JG-8	1050 mW	8.4 mW/°C	672 mW	546 mW	210 mW
N-14	1150 mW	9.2 mW/°C	736 mW	598 mW	230 mW
P-8	1000 mW	8.0 mW/°C	640 mW	520 mW	200 mW
PW-8	525 mW	4.2 mW/°C	336 mW	—	—

## recommended operating conditions

	C SUFFIX		I SUFFIX		M SUFFIX		UNIT
	MIN	MAX	MIN	MAX	MIN	MAX	
Supply voltage, $V_{CC}$	$\pm 2$	$\pm 20$	$\pm 2$	$\pm 20$	$\pm 2$	$\pm 20$	V
Common-mode input voltage, $V_{IC}$	$V_{CC} = \pm 5$ V		0	3.5	0	3.2	V
	$V_{CC\pm} = \pm 15$ V		-15	13.5	-15	13.2	
Operating free-air temperature, $T_A$	0	70	-40	85	-55	125	°C





# TLE202x, TLE202xA, TLE202xB, TLE202xY EXCALIBUR HIGH-SPEED LOW-POWER PRECISION OPERATIONAL AMPLIFIERS

SLOS191C – FEBRUARY 1997 – REVISED APRIL 2007

**TLE2021 electrical characteristics at specified free-air temperature,  $V_{CC} = 5\text{ V}$  (unless otherwise noted)**

PARAMETER	TEST CONDITIONS	$T_A$ †	TLE2021C			TLE2021AC			TLE2021BC			UNIT
			MIN	TYP	MAX	MIN	TYP	MAX	MIN	TYP	MAX	
$V_{IO}$ Input offset voltage	$V_{IC} = 0, R_S = 50\ \Omega$	25°C	120	600	300	100	300	80	200		$\mu\text{V}$	
$\alpha_{VIO}$ Temperature coefficient of input offset voltage		Full range		850	600			2				
Input offset voltage long-term drift (see Note 4)		25°C		0.005			0.005		0.005		$\mu\text{V}/^\circ\text{C}$	
$I_{IO}$ Input offset current	$V_{IC} = 0, R_S = 50\ \Omega$	25°C	0.2	6	6	0.2	6	0.2	6		nA	
$I_{IB}$ Input bias current		Full range			10	10				10		
		25°C		25	70	70	25	70	25	70		
$V_{ICR}$ Common-mode input voltage range	$R_S = 50\ \Omega$	Full range	0	-0.3 to 3.5	0 to 4	0 to 3.5	-0.3 to 4	0 to 3.5	0 to 4		V	
		25°C	4	4.3		4	4.3		4	4.3		
		Full range	3.9			3.9			3.9			
$V_{OH}$ High-level output voltage	$R_L = 10\ \text{k}\Omega$	25°C	0.7	0.8	0.85	0.7	0.8	0.7	0.8		V	
		Full range										
		25°C	0.3	1.5		0.3	1.5		0.3	1.5		
$V_{OL}$ Low-level output voltage	$V_O = 1.4\text{ V to }4\text{ V}, R_L = 10\ \text{k}\Omega$	Full range	0.3	0.3	0.3	0.3	0.3	0.3	0.3		V	
		25°C	85	110		85	110		85	110		
		Full range	80			80			80			
$A_{VD}$ Large-signal differential voltage amplification	$V_{IC} = V_{ICR\text{ min}}, R_S = 50\ \Omega$	25°C	105	120		105	120	105	120		dB	
Full range		100			100			100				
25°C		85	110		85	110		85	110			
$k_{SVR}$ Supply-voltage rejection ratio ( $\Delta V_{CC}/\Delta V_{IO}$ )	$V_{CC} = 5\text{ V to }30\text{ V}$	Full range	200	300		200	300	200	300		dB	
$I_{CC}$ Supply current		25°C	200	300		200	300	200	300			
$\Delta I_{CC}$ Supply-current change over operating temperature range		$V_O = 2.5\text{ V}, \text{ No load}$	Full range	300	300		300	300	300	300		$\mu\text{A}$
		Full range	5			5		5			$\mu\text{A}$	

† Full range is 0°C to 70°C.  
 NOTE 4: Typical values are based on the input offset voltage shift observed through 168 hours of operating life test at  $T_A = 150^\circ\text{C}$  extrapolated to  $T_A = 25^\circ\text{C}$  using the Arrhenius equation and assuming an activation energy of 0.96 eV.



# TLE202x, TLE202xA, TLE202xB, TLE202xY EXCALIBUR HIGH-SPEED LOW-POWER PRECISION OPERATIONAL AMPLIFIERS

SLOS191C – FEBRUARY 1997 – REVISED APRIL 2007

TLE2021 electrical characteristics at specified free-air temperature,  $V_{CC} = \pm 15\text{ V}$  (unless otherwise noted)

PARAMETER	TEST CONDITIONS	TA†	TLE2021C			TLE2021AC			TLE2021BC			UNIT
			MIN	TYP	MAX	MIN	TYP	MAX	MIN	TYP	MAX	
V <sub>IO</sub> Input offset voltage		25°C	120	500	200	80	200	40	100	100	μV	
		Full range		750	500		200		200			
α <sub>VIO</sub> Temperature coefficient of input offset voltage		25°C	2			2		2		2	μV/°C	
		Full range										
Input offset voltage long-term drift (see Note 4)	V <sub>IC</sub> = 0, R <sub>S</sub> = 50 Ω	25°C	0.006			0.006		0.006		0.006	μV/mo	
		Full range										
I <sub>IO</sub> Input offset current		25°C	0.2	6	6	0.2	6	0.2	6	6	nA	
		Full range		10	10		10		10	10		
I <sub>IB</sub> Input bias current		25°C	25	70	70	25	70	25	70	70	nA	
		Full range		90	90		90		90	90		
V <sub>ICR</sub> Common-mode input voltage range	R <sub>S</sub> = 50 Ω	25°C	-15 to 13.5	-15.3 to 14	-15 to 13.5	-15 to 13.5	-15.3 to 14	-15 to 13.5	-15.3 to 14	-15 to 13.5	V	
		Full range										
V <sub>OM+</sub> Maximum positive peak output voltage swing	R <sub>L</sub> = 10 kΩ	25°C	14	14.3	14	14	14.3	14	14.3	14	V	
		Full range		13.9	13.9		13.9		13.9	13.9		
V <sub>OM-</sub> Maximum negative peak output voltage swing	R <sub>L</sub> = 10 kΩ	25°C	-13.7	-14.1	-13.7	-13.7	-14.1	-13.7	-14.1	-13.7	V	
		Full range		-13.7	-13.7		-13.7		-13.7	-13.7		
A <sub>VD</sub> Large-signal differential voltage amplification	V <sub>O</sub> = ± 10 V, R <sub>L</sub> = 10 kΩ	25°C	1	6.5	1	1	6.5	1	6.5	1	V/μV	
		Full range		1	1		1		1	1		
CMRR Common-mode rejection ratio	V <sub>IC</sub> = V <sub>ICR</sub> min, R <sub>S</sub> = 50 Ω	25°C	100	115	100	100	115	100	115	100	dB	
		Full range		96	96		96		96	96		
k <sub>SVR</sub> Supply-voltage rejection ratio (ΔV <sub>CC</sub> /ΔV <sub>IO</sub> )	V <sub>CC</sub> ± ± 2.5 V to ± 15 V	25°C	105	120	105	105	120	105	120	105	dB	
		Full range		100	100		100		100	100		
I <sub>CC</sub> Supply current	V <sub>O</sub> = 0, No load	25°C	240	350	240	240	350	240	350	240	μA	
		Full range		350	350		350		350	350		
ΔI <sub>CC</sub> Supply-current change over operating temperature range	V <sub>O</sub> = 0, No load	25°C	6			6		6		6	μA	
		Full range										

† Full range is 0°C to 70°C.

NOTE 4: Typical values are based on the input offset voltage shift observed through 168 hours of operating life test at T<sub>A</sub> = 150°C extrapolated to T<sub>A</sub> = 25°C using the Arrhenius equation and assuming an activation energy of 0.96 eV.



# TLE202x, TLE202xA, TLE202xB, TLE202xY EXCALIBUR HIGH-SPEED LOW-POWER PRECISION OPERATIONAL AMPLIFIERS

SLOS191C – FEBRUARY 1997 – REVISED APRIL 2007

**TLE2022 electrical characteristics at specified free-air temperature,  $V_{CC} = 5\text{ V}$  (unless otherwise noted)**

PARAMETER	TEST CONDITIONS	$T_A$ †	TLE2022C			TLE2022AC			TLE2022BC			UNIT
			MIN	TYP	MAX	MIN	TYP	MAX	MIN	TYP	MAX	
$V_{IO}$		25°C			600			400			250	$\mu\text{V}$
		Full range			800			550			400	
$\alpha_{VIO}$		Full range		2			2			2		$\mu\text{V}/^\circ\text{C}$
Input offset voltage long-term drift (see Note 4)	$V_{IC} = 0, R_S = 50\ \Omega$	25°C		0.005			0.005			0.005		$\mu\text{V}/\text{mo}$
$I_{IO}$		25°C		0.5	6		0.4	6		0.3	6	nA
		Full range			10			10			10	
$I_{IB}$		25°C		35	70		33	70		30	70	nA
		Full range			90			90			90	
$V_{ICR}$	$R_S = 50\ \Omega$	25°C	0	-0.3 to 3.5	4	0	-0.3 to 3.5	4	0	-0.3 to 3.5	4	V
		Full range	0	to 3.5	to 3.5	0	to 3.5	to 3.5	0	to 3.5	to 4	
$V_{OH}$		25°C	4	4.3		4	4.3		4	4.3		V
		Full range	3.9			3.9			3.9			
$V_{OL}$	$R_L = 10\ \text{k}\Omega$	25°C	0.7	0.8		0.7	0.8		0.7	0.8		V
		Full range	0.85			0.85			0.85		0.85	
$A_{VD}$	$V_O = 1.4\ \text{V to } 4\ \text{V}, R_L = 10\ \text{k}\Omega$	25°C	0.3	1.5		0.4	1.5		0.5	1.5		V/ $\mu\text{V}$
		Full range	0.3			0.4			0.5			
$CMRR$	$V_{IC} = V_{ICRmin}, R_S = 50\ \Omega$	25°C	85	100		87	102		90	105		dB
		Full range	80			82			85			
$k_{SVR}$	$V_{CC} = 5\ \text{V to } 30\ \text{V}$	25°C	100	115		103	118		105	120		dB
		Full range	95			98			100			
$I_{CC}$	$V_O = 2.5\ \text{V},$ No load	25°C	450	600		450	600		450	600		$\mu\text{A}$
		Full range	600			600			600		600	
$\Delta I_{CC}$		Full range	7			7			7			$\mu\text{A}$

† Full range is 0°C to 70°C.  
 NOTE 4: Typical values are based on the input offset voltage shift observed through 168 hours of operating life test at  $T_A = 150^\circ\text{C}$  extrapolated to  $T_A = 25^\circ\text{C}$  using the Arrhenius equation and assuming an activation energy of 0.96 eV.



# TLE202x, TLE202xA, TLE202xB, TLE202xY EXCALIBUR HIGH-SPEED LOW-POWER PRECISION OPERATIONAL AMPLIFIERS

SLOS191C – FEBRUARY 1997 – REVISED APRIL 2007

TLE2022 electrical characteristics at specified free-air temperature,  $V_{CC} = \pm 15$  V (unless otherwise noted)

PARAMETER	TEST CONDITIONS	T <sub>A</sub> †	TLE2022C			TLE2022AC			TLE2022BC			UNIT
			MIN	TYP	MAX	MIN	TYP	MAX	MIN	TYP	MAX	
V <sub>IO</sub>	V <sub>IC</sub> = 0, R <sub>S</sub> = 50 Ω	25°C	150	120	300	150	120	300	150	70	150	μV
Temperature coefficient of input offset voltage		Full range	700	450	300	700	450	300	700	300	300	μV/°C
Input offset voltage long-term drift (see Note 4)		Full range	2	2	2	2	2	2	2	2	2	μV/°C
I <sub>IO</sub>	V <sub>IC</sub> = 0, R <sub>S</sub> = 50 Ω	25°C	0.006	0.006	0.006	0.006	0.006	0.006	0.006	0.006	0.006	μV/mo
Input offset current		25°C	0.5	0.4	6	0.5	0.4	6	0.5	0.3	6	nA
Input bias current		Full range	10	10	10	10	10	10	10	10	10	nA
I <sub>IB</sub>	R <sub>S</sub> = 50 Ω	25°C	35	33	70	35	33	70	35	30	70	nA
Common-mode input voltage range		Full range	90	90	90	90	90	90	90	90	90	nA
		25°C	-15 to 13.5	-15.3 to 14	-15 to 13.5	-15 to 13.5	-15.3 to 14	-15 to 13.5	-15 to 13.5	-15 to 13.5	-15.3 to 14	-15 to 13.5
V <sub>ICR</sub>	R <sub>S</sub> = 50 Ω	Full range	-15 to 13.5	-15 to 13.5	-15 to 13.5	-15 to 13.5	-15 to 13.5	-15 to 13.5	-15 to 13.5	-15 to 13.5	-15 to 13.5	V
V <sub>OM+</sub>		25°C	14	14.3	14	14	14.3	14	14.3	14	14.3	V
		Full range	13.9	13.9	13.9	13.9	13.9	13.9	13.9	13.9	13.9	V
V <sub>OM-</sub>	R <sub>L</sub> = 10 kΩ	25°C	-13.7	-14.1	-13.7	-13.7	-14.1	-13.7	-13.7	-14.1	-13.7	V
A <sub>V/D</sub>	V <sub>O</sub> = ±10 V, R <sub>L</sub> = 10 kΩ	Full range	-13.7	-13.7	-13.7	-13.7	-13.7	-13.7	-13.7	-13.7	-13.7	V
		25°C	0.8	4	4	0.8	4	4	0.8	4	4	V/μV
CMRR	V <sub>IC</sub> = V <sub>ICRmin</sub> , R <sub>S</sub> = 50 Ω	Full range	95	106	97	95	106	97	95	106	97	dB
		25°C	91	91	93	91	91	93	91	91	93	dB
k <sub>SVR</sub>	V <sub>CC±</sub> = ±2.5 V to ±15 V	25°C	100	115	103	100	115	103	100	115	105	dB
		Full range	95	98	98	95	98	98	95	98	98	dB
I <sub>CC</sub>	V <sub>O</sub> = 0, No load	25°C	550	550	700	550	550	700	550	550	700	μA
Supply current		Full range	700	700	700	700	700	700	700	700	700	μA
ΔI <sub>CC</sub>	V <sub>O</sub> = 0, No load	Full range	9	9	9	9	9	9	9	9	9	μA
Supply current change over operating temperature range		Full range	9	9	9	9	9	9	9	9	9	μA

† Full range is 0°C to 70°C.

NOTE 4: Typical values are based on the input offset voltage shift observed through 168 hours of operating life test at T<sub>A</sub> = 150°C extrapolated to T<sub>A</sub> = 25°C using the Arrhenius equation and assuming an activation energy of 0.96 eV.

# TLE202x, TLE202xA, TLE202xB, TLE202xY EXCALIBUR HIGH-SPEED LOW-POWER PRECISION OPERATIONAL AMPLIFIERS

SLOS191C – FEBRUARY 1997 – REVISED APRIL 2007

**TLE2024 electrical characteristics at specified free-air temperature,  $V_{CC} = 5\text{ V}$  (unless otherwise noted)**

PARAMETER	TEST CONDITIONS	$T_A$ †	TLE2024C			TLE2024AC			TLE2024BC			UNIT
			MIN	TYP	MAX	MIN	TYP	MAX	MIN	TYP	MAX	
$V_{IO}$	$V_{IC} = 0, R_S = 50\ \Omega$	25°C	1100		850						600	$\mu\text{V}$
$\alpha_{VIO}$		Full range	1300		1050						800	$\mu\text{V}/^\circ\text{C}$
Input offset voltage long-term drift (see Note 4)		Full range	2								2	$\mu\text{V}/^\circ\text{C}$
$I_{IO}$	$V_{IC} = 0, R_S = 50\ \Omega$	25°C	0.005		0.005						0.005	$\mu\text{V}/\text{mo}$
Input offset current		25°C	0.6	6	0.5	6	0.4	6				nA
Input bias current		Full range	10		10						10	nA
$V_{ICR}$	$R_S = 50\ \Omega$	25°C	0	-0.3 to 3.5	0	-0.3 to 3.5	0	-0.3 to 3.5	0	-0.3 to 3.5	0	V
		Full range	0	to 3.5	0	to 3.5	0	to 3.5	0	to 3.5	0	V
		Full range	3.9	4.2	3.9	4.2	4	4.3	4	4.3	4	V
$V_{OH}$	$R_L = 10\ \text{k}\Omega$	25°C	3.7		3.7						3.8	V
High-level output voltage		Full range	3.7		3.7						3.8	V
$V_{OL}$		25°C	0.7	0.8	0.7	0.8	0.7	0.8	0.7	0.8	0.8	V
$A_{VD}$	$V_O = 1.4\text{ V to }4\text{ V}, R_L = 10\ \text{k}\Omega$	25°C	0.95		0.95						0.95	V
Large-signal differential voltage amplification		Full range	0.2	1.5	0.3	1.5	0.4	1.5	0.4	1.5	1.5	V/ $\mu\text{V}$
$CMRR$		Full range	0.1		0.1		0.1		0.1		0.1	V/ $\mu\text{V}$
$k_{SVR}$	No load	25°C	80	90	82	92	85	95	85	95	95	dB
Common-mode rejection ratio		Full range	80		82		85		85		85	dB
$\Delta_{ICC}$		25°C	98	112	100	115	103	117	103	117	117	dB
$I_{CC}$	$V_O = 2.5\text{ V},$ No load	25°C	93		95						98	dB
Supply current		Full range	800	1200	800	1200	800	1200	800	1200	1200	$\mu\text{A}$
Supply current change over operating temperature range		Full range	1200		1200		1200		1200		1200	$\mu\text{A}$
$\Delta_{ICC}$	No load	Full range	15		15						15	$\mu\text{A}$
Supply current change over operating temperature range		Full range	15		15						15	$\mu\text{A}$

† Full range is 0°C to 70°C.

NOTE 4: Typical values are based on the input offset voltage shift observed through 168 hours of operating life test at  $T_A = 150^\circ\text{C}$  extrapolated to  $T_A = 25^\circ\text{C}$  using the Arrhenius equation and assuming an activation energy of 0.96 eV.



# TLE202x, TLE202xA, TLE202xB, TLE202xY EXCALIBUR HIGH-SPEED LOW-POWER PRECISION OPERATIONAL AMPLIFIERS

SLOS191C – FEBRUARY 1997 – REVISED APRIL 2007

TLE2024 electrical characteristics at specified free-air temperature,  $V_{CC} = \pm 15\text{ V}$  (unless otherwise noted)

PARAMETER	TEST CONDITIONS	$T_A^\dagger$	TLE2024C			TLE2024AC			TLE2024BC			UNIT	
			MIN	TYP	MAX	MIN	TYP	MAX	MIN	TYP	MAX		
$V_{IO}$	$V_{IC} = 0, R_S = 50\ \Omega$	25°C	1000		750						500	$\mu\text{V}$	
		Full range	1200		950						700		
$\alpha_{VIO}$		Full range	2			2					2	$\mu\text{V}/^\circ\text{C}$	
Input offset voltage long-term drift (see Note 4)		25°C	0.006			0.006				0.006	$\mu\text{V}/\text{mo}$		
$I_{IO}$	$V_{IC} = 0, R_S = 50\ \Omega$	25°C	0.6	6	6	0.5	6	6	0.4	6	6	nA	
		Full range	10		10					10	10		
$I_{IB}$		25°C	50	70	70	45	70	70	40	70	70	nA	
		Full range	90		90					90	90		
$V_{ICR}$	$R_S = 50\ \Omega$	25°C	-15 to 13.5	-15.3 to 14	-15 to 13.5	-15 to 13.5	-15.3 to 14	-15 to 13.5	-15.3 to 14	-15 to 13.5	-15.3 to 14	V	
		Full range	-15 to 13.5	-15 to 13.5	-15 to 13.5	-15 to 13.5	-15 to 13.5	-15 to 13.5	-15 to 13.5	-15 to 13.5	-15 to 13.5		
$V_{OM+}$		25°C	13.8	14.1	13.9	14.2	14	14.3	14	14.3	14	V	
		Full range	13.7		13.8			13.9		13.9			
$V_{OM-}$	$R_L = 10\ \text{k}\Omega$	25°C	-13.7	-14.1	-13.7	-14.1	-13.7	-14.1	-13.7	-14.1	-13.7	-14.1	V
		Full range	-13.6		-13.6		-13.6		-13.6		-13.6		
$A_V/D$		25°C	0.4	2	0.8	4	1	7	1	7	1	$\text{V}/\mu\text{V}$	
		Full range	0.4		0.8			1		1			
CMRR	$V_O = \pm 10\ \text{V}, R_L = 10\ \text{k}\Omega$	25°C	92	102	94	105	97	108	97	108	97	108	dB
		Full range	88		90		93		93		93		
kSVR	$V_{IC} = V_{ICRmin}, R_S = 50\ \Omega$	25°C	98	112	100	115	103	117	103	117	103	117	dB
		Full range	93		95		98		98		98		
$I_{CC}$	$V_{CC\pm} = \pm 2.5\ \text{V to } \pm 15\ \text{V}$	25°C	1050	1400	1050	1400	1050	1400	1050	1400	1050	1400	$\mu\text{A}$
		Full range	1400		1400		1400		1400		1400	1400	
$\Delta I_{CC}$		Full range	20		20		20		20		20	20	$\mu\text{A}$

$^\dagger$  Full range is 0°C to 70°C.

NOTE 4: Typical values are based on the input offset voltage shift observed through 168 hours of operating life test at  $T_A = 150^\circ\text{C}$  extrapolated to  $T_A = 25^\circ\text{C}$  using the Arrhenius equation and assuming an activation energy of 0.96 eV.



**TLE202x, TLE202xA, TLE202xB, TLE202xY**  
**EXCALIBUR HIGH-SPEED LOW-POWER PRECISION**  
**OPERATIONAL AMPLIFIERS**

SLOS191C – FEBRUARY 1997 – REVISED APRIL 2007

**TLE2021 electrical characteristics at specified free-air temperature,  $V_{CC} = 5\text{ V}$  (unless otherwise noted)**

PARAMETER	TEST CONDITIONS	$T_A$ †	TLE2021I			TLE2021AI			TLE2021BI			UNIT
			MIN	TYP	MAX	MIN	TYP	MAX	MIN	TYP	MAX	
$V_{IO}$ Input offset voltage		25°C	120		600	100		300	80		200	$\mu\text{V}$
$\alpha_{VIO}$ Temperature coefficient of input offset voltage		Full range		2			2			2		$\mu\text{V}/^\circ\text{C}$
Input offset voltage long-term drift (see Note 4)	$V_{IC} = 0, R_S = 50\ \Omega$	25°C		0.005			0.005			0.005		$\mu\text{V}/\text{mo}$
$I_{IO}$ Input offset current		25°C	0.2		6	0.2		6	0.2		6	nA
		Full range			10			10			10	
$I_{IB}$ Input bias current		25°C	25		70	25		70	25		70	nA
		Full range			90			90			90	
$V_{ICR}$ Common-mode input voltage range	$R_S = 50\ \Omega$	25°C	0	-0.3	0	-0.3	0	-0.3	0	-0.3	0	V
		Full range	3.5	4	3.5	4	3.5	4	3.5	4	3.5	
		Full range	0		0		0		0		0	
		Full range	3.2		3.2		3.2		3.2		3.2	
$V_{OH}$ High-level output voltage		25°C	4	4.3		4	4.3		4	4.3		V
		Full range	3.9			3.9			3.9			
$V_{OL}$ Low-level output voltage		25°C	0.7	0.8		0.7	0.8		0.7	0.8		V
		Full range		0.9			0.9			0.9		
$A_{VD}$ Large-signal differential voltage amplification	$V_O = 1.4\text{ V to }4\text{ V}, R_L = 10\text{ k}\Omega$	25°C	0.3	1.5		0.3	1.5		0.3	1.5		V/ $\mu\text{V}$
		Full range	0.25		0.25		0.25		0.25		0.25	
CMRR Common-mode rejection ratio	$V_{IC} = V_{ICR}\text{ min}, R_S = 50\ \Omega$	25°C	85	110		85	110		85	110		dB
		Full range	80			80			80			
kSVR Supply-voltage rejection ratio ( $\Delta V_{CC}/\Delta V_{IO}$ )	$V_{CC} = 5\text{ V to }30\text{ V}$	25°C	105	120		105	120		105	120		dB
		Full range	100			100			100			
$I_{CC}$ Supply current	$V_O = 2.5\text{ V},$ No load	25°C	200	300		200	300		200	300		$\mu\text{A}$
		Full range	300		300	300		300	300		300	
$\Delta I_{CC}$ Supply-current change over operating temperature range		Full range		6			6			6		$\mu\text{A}$

† Full range is -40°C to 85°C.  
 NOTE 4: Typical values are based on the input offset voltage shift observed through 168 hours of operating life test at  $T_A = 150^\circ\text{C}$  extrapolated to  $T_A = 25^\circ\text{C}$  using the Arrhenius equation and assuming an activation energy of 0.96 eV.



# TLE202x, TLE202xA, TLE202xB, TLE202xY EXCALIBUR HIGH-SPEED LOW-POWER PRECISION OPERATIONAL AMPLIFIERS

SLOS191C – FEBRUARY 1997 – REVISED APRIL 2007

TLE2021 electrical characteristics at specified free-air temperature,  $V_{CC} = \pm 15\text{ V}$  (unless otherwise noted)

PARAMETER	TEST CONDITIONS	TA†	TLE2021I			TLE2021AI			TLE2021BI			UNIT
			MIN	TYP	MAX	MIN	TYP	MAX	MIN	TYP	MAX	
V <sub>IO</sub> Input offset voltage		25°C	120	500	500	80	200	200	40	100	100	μV
		Full range		850	500		200			200		
α <sub>VIO</sub> Temperature coefficient of input offset voltage		25°C	2			2			2			μV/°C
		Full range										
I <sub>IO</sub> Input offset current	V <sub>IC</sub> = 0, R <sub>S</sub> = 50 Ω	25°C	0.006			0.006			0.006			μV/mo
		Full range										
I <sub>IB</sub> Input bias current		25°C	0.2	6	6	0.2	6	6	0.2	6	6	nA
		Full range		10	10		10	10		10	10	
V <sub>ICR</sub> Common-mode input voltage range	R <sub>S</sub> = 50 Ω	25°C	-15 to 13.5	-15.3 to 14	-15 to 14	-15 to 13.5	-15.3 to 14	-15 to 13.5	-15 to 14	-15.3 to 14	-15 to 14	V
		Full range										
V <sub>OM+</sub> Maximum positive peak output voltage swing	R <sub>L</sub> = 10 kΩ	25°C	14	14.3	14	14	14.3	14	14	14.3	14	V
		Full range										
V <sub>OM-</sub> Maximum negative peak output voltage swing		25°C	-13.7	-14.1	-13.7	-13.7	-14.1	-13.7	-13.7	-14.1	-13.7	V
		Full range										
A <sub>V/D</sub> Large-signal differential voltage amplification	V <sub>O</sub> = 10 V, R <sub>L</sub> = 10 kΩ	25°C	1	6.5	1	1	6.5	1	1	6.5	1	V/μV
		Full range										
CMRR Common-mode rejection ratio	V <sub>IC</sub> = V <sub>ICR</sub> min, R <sub>S</sub> = 50 Ω	25°C	100	115	100	100	115	100	100	115	100	dB
		Full range										
kSVR Supply-voltage rejection ratio (ΔV <sub>CC</sub> /ΔV <sub>IO</sub> )	V <sub>CC±</sub> = ±2.5 V to ±15 V	25°C	105	120	105	105	120	105	105	120	105	dB
		Full range										
I <sub>CC</sub> Supply current	V <sub>O</sub> = 0 V, No load	25°C	240	350	240	240	350	240	240	350	240	μA
		Full range										
ΔI <sub>CC</sub> Supply-current change over operating temperature range		25°C	7			7			7			μA
		Full range										

† Full range is -40°C to 85°C.  
 NOTE 4: Typical values are based on the input offset voltage shift observed through 168 hours of operating life test at T<sub>A</sub> = 150°C extrapolated to T<sub>A</sub> = 25°C using the Arrhenius equation and assuming an activation energy of 0.96 eV.





# TLE202x, TLE202xA, TLE202xB, TLE202xY EXCALIBUR HIGH-SPEED LOW-POWER PRECISION OPERATIONAL AMPLIFIERS

SLOS191C – FEBRUARY 1997 – REVISED APRIL 2007

**TLE2022 electrical characteristics at specified free-air temperature,  $V_{CC} = 5\text{ V}$  (unless otherwise noted)**

PARAMETER	TEST CONDITIONS	$T_A$ †	TLE2022I			TLE2022AI			TLE2022BI			UNIT
			MIN	TYP	MAX	MIN	TYP	MAX	MIN	TYP	MAX	
$V_{IO}$	$V_{IC} = 0, R_S = 50\ \Omega$	25°C			600			400			250	$\mu\text{V}$
$\alpha_{VIO}$		Full range			800			550			400	
Input offset voltage long-term drift (see Note 4)		Full range		2			2			2		
$I_{IO}$	$V_{IC} = 0, R_S = 50\ \Omega$	25°C	0.005			0.005			0.005			$\mu\text{V}/\text{mo}$
Input offset current		25°C	0.5	6		0.4	6		0.3	6		nA
$I_{IB}$		Full range		10			10			10		
$V_{ICR}$	$R_S = 50\ \Omega$	25°C	0	-0.3 to 3.5	4	0	-0.3 to 3.5	4	0	-0.3 to 3.5	4	V
		Full range		0 to 3.2			0 to 3.2			0 to 3.2		
		25°C	4	4.3		4	4.3		4	4.3		V
$V_{OH}$	$R_L = 10\ \text{k}\Omega$	Full range	3.9			3.9			3.9			V
$V_{OL}$		25°C	0.7	0.8		0.7	0.8		0.7	0.8		V
Full range			0.9			0.9			0.9			
$A_{VD}$	$V_O = 1.4\text{ V to }4\text{ V}, R_L = 10\ \text{k}\Omega$	25°C	0.3	1.5		0.4	1.5		0.5	1.5		$\text{V}/\mu\text{V}$
CMRR	$V_{IC} = V_{ICRmin}, R_S = 50\ \Omega$	Full range	0.2			0.2			0.2			
		25°C	85	100		87	102		90	105		dB
kSVR	$V_{CC} = 5\text{ V to }30\text{ V}$	Full range	80			82			85			dB
		25°C	100	115		103	118		105	120		
$I_{CC}$	$V_O = 2.5\text{ V}, \text{ No load}$	Full range	95			98			100			
		25°C	450	600		450	600		450	600		$\mu\text{A}$
$\Delta I_{CC}$	$V_O = 2.5\text{ V}, \text{ No load}$	Full range		600			600			600		$\mu\text{A}$
		25°C		600			600			600		
$\Delta I_{CC}$	$V_O = 2.5\text{ V}, \text{ No load}$	Full range	15			15			15			$\mu\text{A}$
		25°C	15			15			15			

† Full range is  $-40^\circ\text{C}$  to  $85^\circ\text{C}$ .  
 NOTE 4: Typical values are based on the input offset voltage shift observed through 168 hours of operating life test at  $T_A = 150^\circ\text{C}$  extrapolated to  $T_A = 25^\circ\text{C}$  using the Arrhenius equation and assuming an activation energy of 0.96 eV.



# TLE202x, TLE202xA, TLE202xB, TLE202xY EXCALIBUR HIGH-SPEED LOW-POWER PRECISION OPERATIONAL AMPLIFIERS

SLOS191C – FEBRUARY 1997 – REVISED APRIL 2007

TLE2022 electrical characteristics at specified free-air temperature,  $V_{CC} = \pm 15\text{ V}$  (unless otherwise noted)

PARAMETER	TEST CONDITIONS	T <sub>A</sub> †	TLE2022I			TLE2022AI			TLE2022BI			UNIT
			MIN	TYP	MAX	MIN	TYP	MAX	MIN	TYP	MAX	
V <sub>IO</sub>	V <sub>I</sub> C = 0, R <sub>S</sub> = 50 Ω	25°C	150	150	500	120	120	300	70	70	150	μV
α <sub>VIO</sub>		Full range			700			450			300	
		Full range		2			2			2		
I <sub>IO</sub>	V <sub>I</sub> C = 0, R <sub>S</sub> = 50 Ω	25°C	0.006	0.006		0.006	0.006		0.006	0.006		μV/mo
		25°C	0.5	0.5	6	0.4	0.4	6	0.3	0.3	6	nA
		Full range			10			10			10	
I <sub>IB</sub>	V <sub>I</sub> C = 0, R <sub>S</sub> = 50 Ω	25°C	35	35	70	33	33	70	30	30	70	nA
		Full range			90			90			90	
		Full range										
V <sub>ICR</sub>	R <sub>S</sub> = 50 Ω	25°C	-15 to 13.5	-15.3 to 14	-15 to 14	-15 to 13.5	-15.3 to 14	-15 to 14	-15 to 13.5	-15.3 to 14	-15 to 14	V
		Full range										
		Full range										
V <sub>OM+</sub>	R <sub>L</sub> = 10 kΩ	25°C	14	14.3		14	14.3		14	14.3		V
		Full range										
		Full range										
V <sub>OM-</sub>	R <sub>L</sub> = 10 kΩ	25°C	-13.7 to -13.6	-14.1 to -13.6	-13.7 to -13.6	-13.7 to -13.6	-14.1 to -13.6	-13.7 to -13.6	-13.7 to -13.6	-14.1 to -13.6	-13.7 to -13.6	V
		Full range										
		Full range										
A <sub>V/D</sub>	V <sub>O</sub> = ±10 V, R <sub>L</sub> = 10 kΩ	25°C	0.8	0.8	4	1	1	7	1.5	1.5	10	V/μV
		Full range										
		Full range										
CMRR	V <sub>I</sub> C = V <sub>ICRmin</sub> , R <sub>S</sub> = 50 Ω	25°C	95	106		97	109		100	112		dB
		Full range										
		Full range										
k <sub>SVR</sub>	V <sub>CC</sub> = ±2.5 V to ±15 V	25°C	100	115		103	118		105	120		dB
		Full range										
		Full range										
I <sub>CC</sub>	V <sub>O</sub> = 0, No load	25°C	550	550	700	550	550	700	550	550	700	μA
		Full range										
		Full range										
ΔI <sub>CC</sub>	V <sub>O</sub> = 0, No load	Full range	30	30		30	30		30	30		μA
		Full range										
		Full range										

† Full range is -40°C to 85°C.  
NOTE 4: Typical values are based on the input offset voltage shift observed through 168 hours of operating life test at T<sub>A</sub> = 150°C extrapolated to T<sub>A</sub> = 25°C using the Arrhenius equation and assuming an activation energy of 0.96 eV.

# TLE202x, TLE202xA, TLE202xB, TLE202xY EXCALIBUR HIGH-SPEED LOW-POWER PRECISION OPERATIONAL AMPLIFIERS

SLOS191C – FEBRUARY 1997 – REVISED APRIL 2007

**TLE2024 electrical characteristics at specified free-air temperature,  $V_{CC} = 5\text{ V}$  (unless otherwise noted)**

PARAMETER	TEST CONDITIONS	$T_A$ †	TLE2024I			TLE2024AI			TLE2024BI			UNIT
			MIN	TYP	MAX	MIN	TYP	MAX	MIN	TYP	MAX	
$V_{IO}$	$V_{IC} = 0, R_S = 50\ \Omega$	25°C			1100			850			600	$\mu\text{V}$
$\alpha_{VIO}$		Full range			1300			1050			800	
Input offset voltage long-term drift (see Note 4)		Full range		2			2				2	$\mu\text{V}/^\circ\text{C}$
$I_{IO}$	$V_{IC} = 0, R_S = 50\ \Omega$	25°C			0.005			0.005			0.005	$\mu\text{V}/\text{mo}$
Input offset current		25°C			0.6			0.5			0.4	nA
$I_{IB}$		Full range			10			10			10	
$V_{ICR}$	$R_S = 50\ \Omega$	25°C			0			0			0	V
		Full range			0 to 3.5			0 to 3.5			0 to 3.5	
		Full range			4			4			4	
$V_{OM+}$	$R_L = 10\ \text{k}\Omega$	25°C			3.9			3.9			4	V
Maximum positive peak output voltage swing		Full range			3.7			3.7			3.8	
$V_{OM-}$		25°C			0.7			0.7			0.7	V
$A_{VD}$	$V_O = 1.4\text{ V to }4\text{ V}, R_L = 10\ \text{k}\Omega$	25°C			0.2			0.3			0.4	$\text{V}/\mu\text{V}$
Large-signal differential voltage amplification		Full range			0.1			0.1			0.1	
$\text{CMRR}$		25°C			80			82			85	dB
$\text{kSVR}$	$V_{IC} = V_{ICR\text{min}}, R_S = 50\ \Omega$	25°C			80			82			85	dB
Common-mode rejection ratio		Full range			80			82			85	
$\Delta\text{V}_{CC\pm}/\Delta V_{IO}$		25°C			98			100			103	dB
$I_{CC}$	No load	25°C			93			95			98	$\mu\text{A}$
Supply current		Full range			800			800			800	
$\Delta I_{CC}$		25°C			1200			1200			1200	$\mu\text{A}$
Supply current change over operating temperature range	$V_O = 0,$	Full range			1200			1200			1200	$\mu\text{A}$
		Full range			30			30			30	$\mu\text{A}$

† Full range is  $-40^\circ\text{C}$  to  $85^\circ\text{C}$ .  
 NOTE 4: Typical values are based on the input offset voltage shift observed through 168 hours of operating life test at  $T_A = 150^\circ\text{C}$  extrapolated to  $T_A = 25^\circ\text{C}$  using the Arrhenius equation and assuming an activation energy of 0.96 eV.



# TLE202x, TLE202xA, TLE202xB, TLE202xY EXCALIBUR HIGH-SPEED LOW-POWER PRECISION OPERATIONAL AMPLIFIERS

SLOS191C – FEBRUARY 1997 – REVISED APRIL 2007

TLE2024 electrical characteristics at specified free-air temperature,  $V_{CC} = \pm 15\text{ V}$  (unless otherwise noted)

PARAMETER	TEST CONDITIONS	$T_A^\dagger$	TLE2024I			TLE2024AI			TLE2024BI			UNIT
			MIN	TYP	MAX	MIN	TYP	MAX	MIN	TYP	MAX	
$V_{IO}$	$V_{IC} = 0, R_S = 50\ \Omega$	25°C	1000		750						500	$\mu\text{V}$
		Full range	1200		950						700	
$\alpha_{VIO}$		Full range	2			2					2	$\mu\text{V}/^\circ\text{C}$
Input offset voltage long-term drift (see Note 4)		25°C	0.006		0.006					0.006	$\mu\text{V}/\text{mo}$	
$I_{IO}$	$V_{IC} = 0, R_S = 50\ \Omega$	25°C	0.6		6					0.4	6	nA
		Full range	10		10					10	10	
$I_{IB}$		25°C	50		70					40	70	nA
		Full range	90		90					90	90	nA
$V_{ICR}$	$R_S = 50\ \Omega$	25°C	-15 to 13.5	-15.3 to 14	-15 to 13.5	-15.3 to 14	-15 to 13.5	-15.3 to 14	-15 to 13.5	-15.3 to 14	-15 to 13.5	V
		Full range	-15 to 13.2	-15 to 13.2	-15 to 13.2	-15 to 13.2	-15 to 13.2	-15 to 13.2	-15 to 13.2	-15 to 13.2	-15 to 13.2	
$V_{OM+}$		25°C	13.8	14.1	13.9	14.2	14	14.3	14	14.3	14	V
		Full range	13.7		13.7			13.8		13.8		
$V_{OM-}$	$R_L = 10\ \text{k}\Omega$	25°C	-13.7	-14.1	-13.7	-14.1	-13.7	-14.1	-13.7	-14.1	-13.7	V
		Full range	-13.6		-13.6		-13.6		-13.6		-13.6	
$A_V/D$		25°C	0.4	2	0.8	4	1	7	1	7	1	V/ $\mu\text{V}$
		Full range	0.4		0.8			1		1		
CMRR	$V_{IC} = V_{ICRmin}, R_S = 50\ \Omega$	25°C	92	102	94	105	97	108	97	108	97	dB
		Full range	88		90		93		93		93	
kSVR	$V_{CC\pm} = \pm 2.5\text{ V to } \pm 15\text{ V}$	25°C	98	112	100	115	103	117	103	117	103	dB
		Full range	93		95		98		98		98	
$I_{CC}$	$V_{O} = 0, \text{ No load}$	25°C	1050	1400	1050	1400	1050	1400	1050	1400	1050	$\mu\text{A}$
		Full range	1400		1400		1400		1400		1400	
$\Delta I_{CC}$		Full range	50		50		50		50		50	$\mu\text{A}$

$^\dagger$  Full range is  $-40^\circ\text{C}$  to  $85^\circ\text{C}$ .  
NOTE 4: Typical values are based on the input offset voltage shift observed through 168 hours of operating life test at  $T_A = 150^\circ\text{C}$  extrapolated to  $T_A = 25^\circ\text{C}$  using the Arrhenius equation and assuming an activation energy of 0.96 eV.

**TLE202x, TLE202xA, TLE202xB, TLE202xY**  
**EXCALIBUR HIGH-SPEED LOW-POWER PRECISION**  
**OPERATIONAL AMPLIFIERS**

SLOS191C – FEBRUARY 1997 – REVISED APRIL 2007

**TLE2021 electrical characteristics at specified free-air temperature,  $V_{CC} = 5\text{ V}$  (unless otherwise noted)**

PARAMETER	TEST CONDITIONS	$T_A$ †	TLE2021M			TLE2021AM			TLE2021BM			UNIT
			MIN	TYP	MAX	MIN	TYP	MAX	MIN	TYP	MAX	
$V_{IO}$	Input offset voltage	25°C	120	600	300	100	300	80	200	300	$\mu\text{V}$	
$\alpha_{VIO}$	Temperature coefficient of input offset voltage	Full range	1100									$\mu\text{V}/^\circ\text{C}$
	Input offset voltage long-term drift (see Note 4)	Full range	2									$\mu\text{V}/^\circ\text{C}$
$I_{IO}$	Input offset current	25°C	0.005									$\mu\text{V}/\text{mo}$
		25°C	0.2	6	6	0.2	6	0.2	6	6	nA	
		Full range	10									nA
$I_{IB}$	Input bias current	25°C	25	70	70	25	70	25	70	70	nA	
		Full range	90									nA
$V_{ICR}$	Common-mode input voltage range	25°C	0	-0.3		0	-0.3	0	-0.3		V	
		Full range	to	to		to	to	to	to			
			3.5	4		3.5	4	3.5	4			
			0			0		0				
			to			to		to				
			3.2			3.2		3.2				
$V_{OH}$	High-level output voltage	25°C	4	4.3		4	4.3	4	4.3		V	
		Full range	3.8									V
$V_{OL}$	Low-level output voltage	25°C	0.7	0.8		0.7	0.8	0.7	0.8		V	
		Full range	0.95									V
$A_{VD}$	Large-signal differential voltage amplification	25°C	0.3	1.5		0.3	1.5	0.3	1.5		V/ $\mu\text{V}$	
		Full range	0.1									V/ $\mu\text{V}$
CMRR	Common-mode rejection ratio	25°C	85	110		85	110	85	110		dB	
		Full range	80									dB
kSVR	Supply-voltage rejection ratio ( $\Delta V_{CC\pm}/\Delta V_{IO}$ )	25°C	105	120		105	120	105	120		dB	
		Full range	100									dB
$I_{CC}$	Supply current	25°C	170	230		170	230	170	230		$\mu\text{A}$	
		Full range	230									$\mu\text{A}$
$\Delta I_{CC}$	Supply current change over operating temperature range	Full range	9									$\mu\text{A}$

† Full range is  $-55^\circ\text{C}$  to  $125^\circ\text{C}$ .  
 NOTE 4: Typical values are based on the input offset voltage shift observed through 168 hours of operating life test at  $T_A = 150^\circ\text{C}$  extrapolated to  $T_A = 25^\circ\text{C}$  using the Arrhenius equation and assuming an activation energy of 0.96 eV.



# TLE202x, TLE202xA, TLE202xB, TLE202xY EXCALIBUR HIGH-SPEED LOW-POWER PRECISION OPERATIONAL AMPLIFIERS

SLOS191C – FEBRUARY 1997 – REVISED APRIL 2007

TLE2021 electrical characteristics at specified free-air temperature,  $V_{CC} = \pm 15\text{ V}$  (unless otherwise noted)

PARAMETER	TEST CONDITIONS	T <sub>A</sub> †	TLE2021M			TLE2021AM			TLE2021BM			UNIT
			MIN	TYP	MAX	MIN	TYP	MAX	MIN	TYP	MAX	
V <sub>IO</sub>	V <sub>IC</sub> = 0, R <sub>S</sub> = 50 Ω	25°C	120	500	200	80	200	40	100	100	μV	
Temperature coefficient of input offset voltage		Full range	1000			500			200			
Input offset voltage long-term drift (see Note 4)		Full range	2			2			2			
I <sub>IO</sub>	V <sub>IC</sub> = 0, R <sub>S</sub> = 50 Ω	25°C	0.006			0.006			0.006			μV/mo
Input offset current		25°C	0.2	6	6	0.2	6	6	0.2	6	6	nA
Input bias current		Full range	10			10			10			
I <sub>IB</sub>	R <sub>S</sub> = 50 Ω	25°C	25	70	70	25	70	25	70	70	nA	
Common-mode input voltage range		Full range	90			90			90			
		25°C	-15	-15.3	-15.3	-15	-15.3	-15.3	-15	-15.3	-15.3	V
V <sub>ICR</sub>	R <sub>S</sub> = 50 Ω	Full range	-15	13.5	14	-15	13.5	14	-15	13.5	14	V
Maximum positive peak output voltage swing		25°C	14	14.3	14.3	14	14.3	14.3	14	14.3	14.3	V
		Full range	13.8			13.8			13.8			
V <sub>OM+</sub>	R <sub>L</sub> = 10 kΩ	25°C	-13.7	-14.1	-14.1	-13.7	-14.1	-13.7	-14.1	-14.1	V	
Maximum negative peak output voltage swing		Full range	-13.6			-13.6			-13.6			
Large-signal differential voltage amplification		25°C	1	6.5	6.5	1	6.5	6.5	1	6.5	6.5	V/μV
	Full range	0.5			0.5			0.5				
A <sub>V/D</sub>	V <sub>O</sub> = ±10 V, R <sub>L</sub> = 10 kΩ	25°C	100	115	115	100	115	100	115	115	dB	
Common-mode rejection ratio		Full range	96			96			96			
		25°C	105	120	120	105	120	120	105	120	120	
CMRR	V <sub>IC</sub> = V <sub>ICRmin</sub> , R <sub>S</sub> = 50 Ω	Full range	100			100			100			
Supply-voltage rejection ratio (ΔV <sub>CC±</sub> /ΔV <sub>IO</sub> )		25°C	100	115	115	100	115	115	100	115	115	dB
		Full range	96			96			96			
I <sub>CC</sub>	V <sub>CC±</sub> = ± 2.5 V to ± 15 V	25°C	200	300	300	200	300	200	300	300	μA	
Supply current		Full range	300			300			300			
		25°C	10	10	10	10	10	10	10	10	10	
ΔI <sub>CC</sub>	V <sub>O</sub> = 0, No load	Full range	10			10			10			
Supply current change over operating temperature range		25°C	10			10			10			
		Full range	10			10			10			

† Full range is -55°C to 125°C.

NOTE 4: Typical values are based on the input offset voltage shift observed through 168 hours of operating life test at T<sub>A</sub> = 150°C extrapolated to T<sub>A</sub> = 25°C using the Arrhenius equation and assuming an activation energy of 0.96 eV.



# TLE202x, TLE202xA, TLE202xB, TLE202xY EXCALIBUR HIGH-SPEED LOW-POWER PRECISION OPERATIONAL AMPLIFIERS

SLOS191C – FEBRUARY 1997 – REVISED APRIL 2007

**TLE2022 electrical characteristics at specified free-air temperature,  $V_{CC} = 5\text{ V}$  (unless otherwise noted)**

PARAMETER	TEST CONDITIONS	$T_A$ †	TLE2022M			TLE2022AM			TLE2022BM			UNIT
			MIN	TYP	MAX	MIN	TYP	MAX	MIN	TYP	MAX	
$V_{IO}$	$V_{IC} = 0, R_S = 50\ \Omega$	25°C			600			400			250	$\mu\text{V}$
Temperature coefficient of input offset voltage		Full range			800			550			400	$\mu\text{V}/^\circ\text{C}$
Input offset voltage long-term drift (see Note 4)		Full range		2				2			2	$\mu\text{V}/\text{mo}$
$I_{IO}$	$V_{IC} = 0, R_S = 50\ \Omega$	25°C	0.005			0.005			0.005		0.005	$\mu\text{V}/\text{mo}$
Input offset current		25°C	0.5	6		0.4	6		0.3	6		nA
Input bias current		Full range		10			10			10		nA
$I_{IB}$	$V_{IC} = 0, R_S = 50\ \Omega$	25°C	35	70		33	70		30	70		nA
		Full range		90			90			90		nA
$V_{ICR}$	$R_S = 50\ \Omega$	25°C	0	-0.3 to 3.5	4	0	-0.3 to 3.5	4	0	-0.3 to 3.5	4	V
		Full range		0 to 3.2			0 to 3.2			0 to 3.2		V
$V_{OH}$	$R_L = 10\ \text{k}\Omega$	25°C	4	4.3		4	4.3		4	4.3		V
High-level output voltage		Full range		3.8			3.8			3.8		V
$V_{OL}$	$R_L = 10\ \text{k}\Omega$	25°C	0.7	0.8		0.7	0.8		0.7	0.8		V
Low-level output voltage		Full range		0.95			0.95			0.95		V
$A_{VD}$	$V_O = 1.4\text{ V to }4\text{ V}, R_L = 10\ \text{k}\Omega$	25°C	0.3	1.5		0.4	1.5		0.5	1.5		V/ $\mu\text{V}$
CMRR	$V_{IC} = V_{ICRmin}, R_S = 50\ \Omega$	Full range	0.1			0.1			0.1			V/ $\mu\text{V}$
		25°C	85	100		87	102		90	105		dB
kSVR	$V_{CC} = 5\text{ V to }30\text{ V}$	Full range	80			82			85			dB
		25°C	100	115		103	118		105	120		dB
$I_{CC}$	$V_O = 2.5\text{ V}, \text{ No load}$	Full range	95			98			100			dB
		25°C	450	600		450	600		450	600		$\mu\text{A}$
$\Delta I_{CC}$	$V_O = 2.5\text{ V}, \text{ No load}$	Full range	600			600			600			$\mu\text{A}$
		Full range		37			37			37		$\mu\text{A}$

† Full range is  $-55^\circ\text{C to }125^\circ\text{C}$ .  
 NOTE 4: Typical values are based on the input offset voltage shift observed through 168 hours of operating life test at  $T_A = 150^\circ\text{C}$  extrapolated to  $T_A = 25^\circ\text{C}$  using the Arrhenius equation and assuming an activation energy of 0.96 eV.



# TLE202x, TLE202xA, TLE202xB, TLE202xY EXCALIBUR HIGH-SPEED LOW-POWER PRECISION OPERATIONAL AMPLIFIERS

SLOS191C – FEBRUARY 1997 – REVISED APRIL 2007

TLE2022 electrical characteristics at specified free-air temperature,  $V_{CC} = \pm 15$  V (unless otherwise noted)

PARAMETER	TEST CONDITIONS	T <sub>A</sub> †	TLE2022M			TLE2022AM			TLE2022BM			UNIT
			MIN	TYP	MAX	MIN	TYP	MAX	MIN	TYP	MAX	
V <sub>IO</sub>		25°C	150	150	500	120	120	300	70	70	150	μV
		Full range			700			450			300	
α <sub>VIO</sub>		Full range		2			2			2		μV/°C
	V <sub>IC</sub> = 0, R <sub>S</sub> = 50 Ω	25°C		0.006			0.006			0.006		μV/mo
I <sub>IO</sub>		25°C		0.5	6		0.4	6		0.3	6	nA
		Full range			10			10			10	
I <sub>IB</sub>		25°C		35	70		33	70		30	70	nA
		Full range			90			90			90	
V <sub>ICR</sub>	Common-mode input voltage range	25°C	-15 to 13.5	-15.3 to 14	-15 to 13.2	-15 to 13.5	-15.3 to 14	-15 to 13.2	-15 to 13.5	-15.3 to 14	-15 to 13.2	V
		Full range										
V <sub>OM+</sub>	Maximum positive peak output voltage swing	25°C	14	14.3		14	14.3		14	14.3		V
		Full range										
V <sub>OM-</sub>	Maximum negative peak output voltage swing	25°C	-13.7	-14.1		-13.7	-14.1		-13.7	-14.1		V
		Full range										
A <sub>V/D</sub>	Large-signal differential voltage amplification	25°C	0.8	4		1	7		1.5	10		V/μV
		Full range							1.5			
CMRR	Common-mode rejection ratio	25°C	95	106		97	109		100	112		dB
		Full range							96			
k <sub>SVR</sub>	Supply-voltage rejection ratio (ΔV <sub>CC±</sub> /ΔV <sub>IO</sub> )	25°C	100	115		103	118		105	120		dB
		Full range							100			
I <sub>CC</sub>	Supply current	25°C		550	700		550	700		550	700	μA
		Full range			700			700			700	
ΔI <sub>CC</sub>	Supply current change over operating temperature range	Full range		60			60			60		μA

† Full range is 0°C to 70°C.

NOTE 4: Typical values are based on the input offset voltage shift observed through 168 hours of operating life test at T<sub>A</sub> = 150°C extrapolated to T<sub>A</sub> = 25°C using the Arrhenius equation and assuming an activation energy of 0.96 eV.



# TLE202x, TLE202xA, TLE202xB, TLE202xY EXCALIBUR HIGH-SPEED LOW-POWER PRECISION OPERATIONAL AMPLIFIERS

SLOS191C – FEBRUARY 1997 – REVISED APRIL 2007

**TLE2024 electrical characteristics at specified free-air temperature,  $V_{CC} = 5\text{ V}$  (unless otherwise noted)**

PARAMETER	TEST CONDITIONS	$T_A$ †	TLE2024M			TLE2024AM			TLE2024BM			UNIT
			MIN	TYP	MAX	MIN	TYP	MAX	MIN	TYP	MAX	
$V_{IO}$	$V_{IC} = 0$ , $R_S = 50\ \Omega$	25°C	1100		850						600	$\mu\text{V}$
Temperature coefficient of input offset voltage		Full range	1300		1050						800	$\mu\text{V}/^\circ\text{C}$
Input offset voltage long-term drift (see Note 4)		Full range	2								2	$\mu\text{V}/^\circ\text{C}$
$I_{IO}$	$V_{IC} = 0$ , $R_S = 50\ \Omega$	25°C	0.005		0.005						0.005	$\mu\text{V}/\text{mo}$
Input offset current		25°C	0.6	6	6	0.5	6	6	0.4	6	6	nA
Input bias current		Full range	10		10						10	nA
$I_{IB}$	$R_S = 50\ \Omega$	25°C	45	70	70	40	70	35	70	70	70	nA
Common-mode input voltage range		Full range	90		90						90	nA
$V_{ICR}$		25°C	0	-0.3 to 3.5	0 to 4	-0.3 to 3.5	0 to 4	0 to 3.5	-0.3 to 4	0 to 3.5	0 to 4	V
$V_{OM+}$	$R_L = 10\ \text{k}\Omega$	Full range	0	to 3.2	0	to 3.2	0	to 3.2	0	to 3.2	0	V
Maximum positive peak output voltage swing		25°C	3.9	4.2	3.9	4.2	4	4.3	4	4.3	4	V
Maximum negative peak output voltage swing		Full range	3.7		3.7		3.8		3.8		3.8	V
$A_{VD}$	$V_O = 1.4\text{ V to }4\text{ V}$ , $R_L = 10\ \text{k}\Omega$	25°C	0.7	0.8	0.7	0.8	0.7	0.8	0.7	0.8	0.8	V
Large-signal differential voltage amplification		Full range	0.95		0.95		0.95		0.95		0.95	V
Common-mode rejection ratio		25°C	0.2	1.5	0.3	1.5	0.4	1.5	0.4	1.5	1.5	V/ $\mu\text{V}$
$\text{CMRR}$	$V_{IC} = V_{ICR\text{min}}$ , $R_S = 50\ \Omega$	Full range	0.1		0.1		0.1		0.1		0.1	V/ $\mu\text{V}$
Supply-voltage rejection ratio ( $\Delta V_{CC\pm}/\Delta V_{IO}$ )		25°C	80	90	82	92	85	95	85	95	95	dB
Supply current		Full range	80		82		85		85		85	dB
$\Delta I_{CC}$	No load	25°C	98	112	100	115	103	117	103	117	117	dB
Supply current change over operating temperature range		Full range	93		95		98		98		98	dB
Supply current change over operating temperature range		25°C	800	1200	800	1200	800	1200	800	1200	1200	$\mu\text{A}$
$\Delta I_{CC}$	No load	Full range	1200		1200		1200		1200		1200	$\mu\text{A}$
Supply current change over operating temperature range		Full range	50		50		50		50		50	$\mu\text{A}$

† Full range is -55°C to 125°C.  
NOTE 4: Typical values are based on the input offset voltage shift observed through 168 hours of operating life test at  $T_A = 150^\circ\text{C}$  extrapolated to  $T_A = 25^\circ\text{C}$  using the Arrhenius equation and assuming an activation energy of 0.96 eV.



# TLE202x, TLE202xA, TLE202xB, TLE202xY EXCALIBUR HIGH-SPEED LOW-POWER PRECISION OPERATIONAL AMPLIFIERS

SLOS191C – FEBRUARY 1997 – REVISED APRIL 2007

TLE2024 electrical characteristics at specified free-air temperature,  $V_{CC} = \pm 15\text{ V}$  (unless otherwise noted)

PARAMETER	TEST CONDITIONS	$T_A^\dagger$	TLE2024M			TLE2024AM			TLE2024BM			UNIT
			MIN	TYP	MAX	MIN	TYP	MAX	MIN	TYP	MAX	
$V_{IO}$	$V_{IC} = 0, R_S = 50\ \Omega$	25°C	1000		750						500	$\mu\text{V}$
		Full range	1200		950						700	
$\alpha_{VIO}$		Full range	2			2					2	$\mu\text{V}/^\circ\text{C}$
Input offset voltage long-term drift (see Note 4)		25°C	0.006		0.006					0.006	$\mu\text{V}/\text{mo}$	
$I_{IO}$	$V_{IC} = 0, R_S = 50\ \Omega$	25°C	0.6	6	6	0.5	6	6	0.4	6	nA	
		Full range	10		10					10		
$I_{IB}$		25°C	50	70	70	45	70	70	40	70	nA	
	Full range	90		90					90			
$V_{ICR}$	$R_S = 50\ \Omega$	25°C	-15 to 13.5	-15.3 to 14	-15 to 13.5	-15.3 to 14	-15 to 13.5	-15.3 to 14	-15 to 13.5	-15.3 to 14	V	
		Full range	-15 to 13.2		-15 to 13.2				-15 to 13.2			
$V_{OM+}$		25°C	13.8	14.1	13.9	14.2	14	14.3	13.8	14.3	V	
	Full range	13.7		13.7				13.8				
$V_{OM-}$	$R_L = 10\ \text{k}\Omega$	25°C	-13.7	-14.1	-13.7	-14.1	-13.7	-14.1	-13.7	-14.1	V	
		Full range	-13.6		-13.6				-13.6			
$A_V/D$		25°C	0.4	2	0.8	4	1	7	1	7	$\text{V}/\mu\text{V}$	
	Full range	0.4		0.8				1				
$CMRR$	$V_O = \pm 10\ \text{V}, R_L = 10\ \text{k}\Omega$	25°C	92	102	94	105	97	108	93	108	dB	
		Full range	88		90				93			
$kSVR$		25°C	98	112	100	115	103	117	98	117	dB	
	Full range	93		95				98				
$I_{CC}$	$V_{CC\pm} = \pm 2.5\ \text{V to } \pm 15\ \text{V}$	25°C	1050	1400	1050	1400	1050	1400	1050	1400	$\mu\text{A}$	
		Full range	1400		1400				1400			
$\Delta I_{CC}$		25°C	85		85				85		$\mu\text{A}$	
	Full range	85		85				85				

$^\dagger$  Full range is  $-55^\circ\text{C}$  to  $125^\circ\text{C}$ .  
NOTE 4: Typical values are based on the input offset voltage shift observed through 168 hours of operating life test at  $T_A = 150^\circ\text{C}$  extrapolated to  $T_A = 25^\circ\text{C}$  using the Arrhenius equation and assuming an activation energy of 0.96 eV.



**TLE202x, TLE202xA, TLE202xB, TLE202xY**  
**EXCALIBUR HIGH-SPEED LOW-POWER PRECISION**  
**OPERATIONAL AMPLIFIERS**

SLOS191C – FEBRUARY 1997 – REVISED APRIL 2007

**TLE2021 operating characteristics,  $V_{CC} = 5\text{ V}$ ,  $T_A = 25^\circ\text{C}$**

PARAMETER	TEST CONDITIONS	$T_A$	C SUFFIX			I SUFFIX			M SUFFIX			UNIT
			MIN	TYP	MAX	MIN	TYP	MAX	MIN	TYP	MAX	
SR	Slew rate at unity gain		0.5			0.5			0.5			V/ $\mu\text{s}$
$V_n$	Equivalent input noise voltage (see Figure 2)	25°C	21			21			21			nV/Hz
		25°C	17			17			17			
$V_N(\text{PP})$	Peak-to-peak equivalent input noise voltage	25°C	0.16			0.16			0.16			$\mu\text{V}$
		25°C	0.47			0.47			0.47			
$I_n$	Equivalent input noise current	25°C	0.09			0.09			0.09			pA/Hz
$B_1$	Unity-gain bandwidth	25°C	1.2			1.2			1.2			MHz
$\phi_m$	Phase margin at unity gain	25°C	42°			42°			42°			

**TLE2021 operating characteristics at specified free-air temperature,  $V_{CC} = \pm 15\text{ V}$**

PARAMETER	TEST CONDITIONS	$T_A$ †	C SUFFIX			I SUFFIX			M SUFFIX			UNIT
			MIN	TYP	MAX	MIN	TYP	MAX	MIN	TYP	MAX	
SR	Slew rate at unity gain		0.45			0.45			0.45			V/ $\mu\text{s}$
		Full range	0.45			0.42			0.45			
$V_n$	Equivalent input noise voltage (see Figure 2)	25°C	19			19			19			nV/Hz
		25°C	15			15			15			
$V_N(\text{PP})$	Peak-to-peak equivalent input noise voltage	25°C	0.16			0.16			0.16			$\mu\text{V}$
		25°C	0.47			0.47			0.47			
$I_n$	Equivalent input noise current	25°C	0.09			0.09			0.09			pA/Hz
$B_1$	Unity-gain bandwidth	25°C	2			2			2			MHz
$\phi_m$	Phase margin at unity gain	25°C	46°			46°			46°			

† Full range is 0°C to 70°C for the C-suffix devices, –40°C to 85°C for the I-suffix devices, and –55°C to 125°C for the M-suffix devices.



**TLE202x, TLE202xA, TLE202xB, TLE202xY**  
**EXCALIBUR HIGH-SPEED LOW-POWER PRECISION**  
**OPERATIONAL AMPLIFIERS**

SLOS191C – FEBRUARY 1997 – REVISED APRIL 2007

**TLE2022 operating characteristics,  $V_{CC} = 5\text{ V}$ ,  $T_A = 25^\circ\text{C}$**

PARAMETER	TEST CONDITIONS	C SUFFIX			I SUFFIX			M SUFFIX			UNIT
		MIN	TYP	MAX	MIN	TYP	MAX	MIN	TYP	MAX	
SR	Slew rate at unity gain $V_O = 1\text{ V to }3\text{ V}$ , See Figure 1		0.5			0.5			0.5		$\text{V}/\mu\text{s}$
$V_n$	Equivalent input noise voltage (see Figure 2)		21	50		21	50		21		$\text{nV}/\sqrt{\text{Hz}}$
			17	30		17	30		17		
$V_{N(PP)}$	Peak-to-peak equivalent input noise voltage		0.16			0.16			0.16		$\mu\text{V}$
			0.47			0.47			0.47		
$I_n$	Equivalent input noise current		0.1			0.1			0.1		$\text{pA}/\sqrt{\text{Hz}}$
$B_1$	Unity-gain bandwidth		1.7			1.7			1.7		MHz
$\phi_m$	Phase margin at unity gain		47°			47°			47°		

**TLE2022 operating characteristics at specified free-air temperature,  $V_{CC} = \pm 15\text{ V}$**

PARAMETER	TEST CONDITIONS	$T_A^\dagger$	C SUFFIX			I SUFFIX			M SUFFIX			UNIT
			MIN	TYP	MAX	MIN	TYP	MAX	MIN	TYP	MAX	
SR	Slew rate at unity gain $V_O = \pm 10\text{ V}$ , See Figure 1	25°C	0.45	0.65		0.45	0.65		0.45	0.65		$\text{V}/\mu\text{s}$
		Full range	0.45			0.42			0.4			
$V_n$	Equivalent input noise voltage (see Figure 2)	25°C		19	50		19	50		19		$\text{nV}/\sqrt{\text{Hz}}$
		25°C		15	30		15	30		15		
$V_{N(PP)}$	Peak-to-peak equivalent input noise voltage	25°C		0.16			0.16			0.16		$\mu\text{V}$
		25°C		0.47			0.47			0.47		
$I_n$	Equivalent input noise current	25°C		0.1			0.1			0.1	$\text{pA}/\sqrt{\text{Hz}}$	
$B_1$	Unity-gain bandwidth	25°C		2.8			2.8			2.8	MHz	
$\phi_m$	Phase margin at unity gain	25°C		52°			52°			52°		

† Full range is 0°C to 70°C.



**TLE202x, TLE202xA, TLE202xB, TLE202xY**  
**EXCALIBUR HIGH-SPEED LOW-POWER PRECISION**  
**OPERATIONAL AMPLIFIERS**

SLOS191C – FEBRUARY 1997 – REVISED APRIL 2007

**TLE2024 operating characteristics,  $V_{CC} = 5\text{ V}$ ,  $T_A = 25^\circ\text{C}$**

PARAMETER	TEST CONDITIONS	C SUFFIX			I SUFFIX			M SUFFIX			UNIT
		MIN	TYP	MAX	MIN	TYP	MAX	MIN	TYP	MAX	
SR	Slew rate at unity gain	$V_O = 1\text{ V to }3\text{ V}$ , See Figure 1									V/ $\mu\text{s}$
$V_n$	Equivalent input noise voltage (see Figure 2)	$f = 10\text{ Hz}$									nV/ $\sqrt{\text{Hz}}$
		$f = 1\text{ kHz}$									
$V_{N(PP)}$	Peak-to-peak equivalent input noise voltage	$f = 0.1\text{ to }1\text{ Hz}$									$\mu\text{V}$
		$f = 0.1\text{ to }10\text{ Hz}$									
$I_n$	Equivalent input noise current	0.1									pA/ $\sqrt{\text{Hz}}$
$B_1$	Unity-gain bandwidth	1.7									MHz
$\phi_m$	Phase margin at unity gain	47°									47°

**TLE2024 operating characteristics at specified free-air temperature,  $V_{CC} = \pm 15\text{ V}$  (unless otherwise noted)**

PARAMETER	TEST CONDITIONS	$T_A^\dagger$	C SUFFIX			I SUFFIX			M SUFFIX			UNIT
			MIN	TYP	MAX	MIN	TYP	MAX	MIN	TYP	MAX	
SR	Slew rate at unity gain	25°C	0.45	0.7		0.45	0.7		0.45	0.7		V/ $\mu\text{s}$
		Full range	0.45			0.42			0.4			
$V_n$	Equivalent input noise voltage (see Figure 2)	25°C	19	50		19	50		19	50		nV/ $\sqrt{\text{Hz}}$
		25°C	15	30		15	30		15	30		
$V_{N(PP)}$	Peak-to-peak equivalent input noise voltage	25°C	0.16			0.16			0.16			$\mu\text{V}$
		25°C	0.47			0.47			0.47			
$I_n$	Equivalent input noise current	25°C	0.1			0.1			0.1		pA/ $\sqrt{\text{Hz}}$	
$B_1$	Unity-gain bandwidth	25°C	2.8			2.8			2.8		MHz	
$\phi_m$	Phase margin at unity gain	25°C	52°			52°			52°		52°	

† Full range is 0°C to 70°C.



**TLE202x, TLE202xA, TLE202xB, TLE202xY**  
**EXCALIBUR HIGH-SPEED LOW-POWER PRECISION**  
**OPERATIONAL AMPLIFIERS**

SLOS191C – FEBRUARY 1997 – REVISED APRIL 2007

**TLE2021Y electrical characteristics at  $V_{CC} = 5\text{ V}$ ,  $T_A = 25^\circ\text{C}$  (unless otherwise noted)**

PARAMETER	TEST CONDITIONS	TLE2021Y			UNIT
		MIN	TYP	MAX	
$V_{IO}$ Input offset voltage	$V_{IC} = 0$ , $R_S = 50\ \Omega$	150			$\mu\text{V}$
Input offset voltage long-term drift (see Note 4)		0.005			$\mu\text{V}/\text{mo}$
$I_{IO}$ Input offset current		0.5			nA
$I_{IB}$ Input bias current		35			nA
$V_{ICR}$ Common-mode input voltage range	$R_S = 50\ \Omega$	-0.3 to 4			V
$V_{OH}$ Maximum high-level output voltage	$R_L = 10\ \text{k}\Omega$	4.3			V
$V_{OL}$ Maximum low-level output voltage		0.7			V
$A_{VD}$ Large-signal differential voltage amplification	$V_O = 1.4\ \text{to}\ 4\ \text{V}$ , $R_L = 10\ \text{k}\Omega$	1.5			$\text{V}/\mu\text{V}$
CMRR Common-mode rejection ratio	$V_{IC} = V_{ICR}\ \text{min}$ , $R_S = 50\ \Omega$	100			dB
$k_{SVR}$ Supply-voltage rejection ratio ( $\Delta V_{CC\pm} / \Delta V_{IO}$ )	$V_{CC} = 5\ \text{V}\ \text{to}\ 30\ \text{V}$	115			dB
$I_{CC}$ Supply current	$V_O = 2.5\ \text{V}$ , No load	400			$\mu\text{A}$

NOTE 4: Typical values are based on the input offset voltage shift observed through 168 hours of operating life test at  $T_A = 150^\circ\text{C}$  extrapolated to  $T_A = 25^\circ\text{C}$  using the Arrhenius equation and assuming an activation energy of 0.96 eV.

**TLE2021Y operating characteristics at  $V_{CC} = 5\text{ V}$ ,  $T_A = 25^\circ\text{C}$**

PARAMETER	TEST CONDITIONS	TLE2021Y			UNIT
		MIN	TYP	MAX	
SR Slew rate at unity gain	$V_O = 1\ \text{V}\ \text{to}\ 3\ \text{V}$	0.5			$\text{V}/\mu\text{s}$
$V_n$ Equivalent input noise voltage	$f = 10\ \text{Hz}$	21			$\text{nV}/\sqrt{\text{Hz}}$
	$f = 1\ \text{kHz}$	17			
$V_{N(PP)}$ Peak-to-peak equivalent input noise voltage	$f = 0.1\ \text{to}\ 1\ \text{Hz}$	0.16			$\mu\text{V}$
	$f = 0.1\ \text{to}\ 10\ \text{Hz}$	0.47			
$I_n$ Equivalent input noise current		0.1			$\text{pA}/\sqrt{\text{Hz}}$
$B_1$ Unity-gain bandwidth		1.7			MHz
$\phi_m$ Phase margin at unity gain		47°			



# TLE202x, TLE202xA, TLE202xB, TLE202xY EXCALIBUR HIGH-SPEED LOW-POWER PRECISION OPERATIONAL AMPLIFIERS

SLOS191C – FEBRUARY 1997 – REVISED APRIL 2007

## TLE2022Y electrical characteristics, $V_{CC} = 5\text{ V}$ , $T_A = 25^\circ\text{C}$ (unless otherwise noted)

PARAMETER	TEST CONDITIONS	TLE2022Y			UNIT
		MIN	TYP	MAX	
$V_{IO}$ Input offset voltage	$V_{IC} = 0$ , $R_S = 50\ \Omega$		150	600	$\mu\text{V}$
Input offset voltage long-term drift (see Note 4)			0.005		$\mu\text{V}/\text{mo}$
$I_{IO}$ Input offset current			0.5		nA
$I_{IB}$ Input bias current			35		nA
$V_{ICR}$ Common-mode input voltage range	$R_S = 50\ \Omega$		-0.3 to 4		V
$V_{OH}$ Maximum high-level output voltage	$R_L = 10\ \text{k}\Omega$		4.3		V
$V_{OL}$ Maximum low-level output voltage			0.7		V
$A_{VD}$ Large-signal differential voltage amplification	$V_O = 1.4\text{ to }4\text{ V}$ , $R_L = 10\ \text{k}\Omega$		1.5		$\text{V}/\mu\text{V}$
CMRR Common-mode rejection ratio	$V_{IC} = V_{ICR}\ \text{min}$ , $R_S = 50\ \Omega$		100		dB
$k_{SVR}$ Supply-voltage rejection ratio ( $\Delta V_{CC\pm}/\Delta V_{IO}$ )	$V_{CC} = 5\text{ V to }30\text{ V}$		115		dB
$I_{CC}$ Supply current	$V_O = 2.5\text{ V}$ , No load		450		$\mu\text{A}$

NOTE 4: Typical values are based on the input offset voltage shift observed through 168 hours of operating life test at  $T_A = 150^\circ\text{C}$  extrapolated to  $T_A = 25^\circ\text{C}$  using the Arrhenius equation and assuming an activation energy of 0.96 eV.

## TLE2022Y operating characteristics, $V_{CC} = 5\text{ V}$ , $T_A = 25^\circ\text{C}$

PARAMETER	TEST CONDITIONS	TLE2022Y			UNIT
		MIN	TYP	MAX	
SR Slew rate at unity gain	$V_O = 1\text{ V to }3\text{ V}$ , See Figure 1		0.5		$\text{V}/\mu\text{s}$
$V_n$ Equivalent input noise voltage (see Figure 2)	$f = 10\ \text{Hz}$		21		$\text{nV}/\sqrt{\text{Hz}}$
	$f = 1\ \text{kHz}$		17		
$V_{N(PP)}$ Peak-to-peak equivalent input noise voltage	$f = 0.1\text{ to }1\ \text{Hz}$		0.16		$\mu\text{V}$
	$f = 0.1\text{ to }10\ \text{Hz}$		0.47		
$I_n$ Equivalent input noise current			0.1		$\text{pA}/\sqrt{\text{Hz}}$
$B_1$ Unity-gain bandwidth	See Figure 3		1.7		MHz
$\phi_m$ Phase margin at unity gain	See Figure 3		47°		



# TLE202x, TLE202xA, TLE202xB, TLE202xY EXCALIBUR HIGH-SPEED LOW-POWER PRECISION OPERATIONAL AMPLIFIERS

SLOS191C – FEBRUARY 1997 – REVISED APRIL 2007

## TLE2024Y electrical characteristics, $V_{CC} = 5\text{ V}$ , $T_A = 25^\circ\text{C}$ (unless otherwise noted)

PARAMETER	TEST CONDITIONS	TLE2024Y			UNIT
		MIN	TYP	MAX	
Input offset voltage long-term drift (see Note 4)			0.005		$\mu\text{V}/\text{mo}$
$I_{IO}$ Input offset current	$V_{IC} = 0$ , $R_S = 50\ \Omega$		0.6		nA
$I_{IB}$ Input bias current			45		nA
$V_{ICR}$ Common-mode input voltage range	$R_S = 50\ \Omega$		-0.3 to 4		V
$V_{OH}$ High-level output voltage	$R_L = 10\ \text{k}\Omega$		4.2		V
$V_{OL}$ Low-level output voltage			0.7		V
$A_{VD}$ Large-signal differential voltage amplification	$V_O = 1.4\ \text{V to } 4\ \text{V}$ , $R_L = 10\ \text{k}\Omega$		1.5		$\text{V}/\mu\text{V}$
CMRR Common-mode rejection ratio	$V_{IC} = V_{ICR\text{min}}$ , $R_S = 50\ \Omega$		90		dB
$k_{SVR}$ Supply-voltage rejection ratio ( $\Delta V_{CC}/\Delta V_{IO}$ )	$V_{CC} = 5\ \text{V to } 30\ \text{V}$		112		dB
$I_{CC}$ Supply current	$V_O = 2.5\ \text{V}$ , No load		800		$\mu\text{A}$

NOTE 4. Typical values are based on the input offset voltage shift observed through 168 hours of operating life test at  $T_A = 150^\circ\text{C}$  extrapolated to  $T_A = 25^\circ\text{C}$  using the Arrhenius equation and assuming an activation energy of 0.96 eV.

## TLE2024Y operating characteristics, $V_{CC} = 5\ \text{V}$ , $T_A = 25^\circ\text{C}$

PARAMETER	TEST CONDITIONS	TLE2024Y			UNIT
		MIN	TYP	MAX	
SR Slew rate at unity gain	$V_O = 1\ \text{V to } 3\ \text{V}$ , See Figure 1		0.5		$\text{V}/\mu\text{s}$
$V_n$ Equivalent input noise voltage (see Figure 2)	$f = 10\ \text{Hz}$		21		$\text{nV}/\sqrt{\text{Hz}}$
	$f = 1\ \text{kHz}$		17		
$V_{N(PP)}$ Peak-to-peak equivalent input noise voltage	$f = 0.1\ \text{to } 1\ \text{Hz}$		0.16		$\mu\text{V}$
	$f = 0.1\ \text{to } 10\ \text{Hz}$		0.47		
$I_n$ Equivalent input noise current			0.1		$\text{pA}/\sqrt{\text{Hz}}$
$B_1$ Unity-gain bandwidth	See Figure 3		1.7		MHz
$\phi_m$ Phase margin at unity gain	See Figure 3		47°		



PARAMETER MEASUREMENT INFORMATION

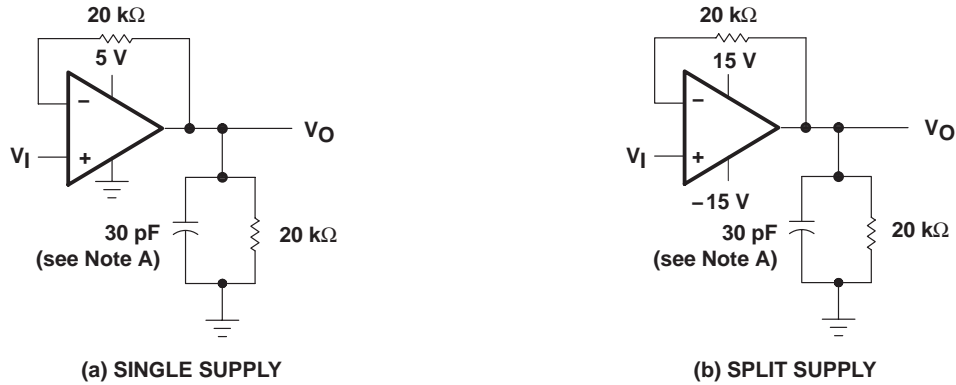

NOTE A:  $C_L$  includes fixture capacitance.

Figure 1. Slew-Rate Test Circuit

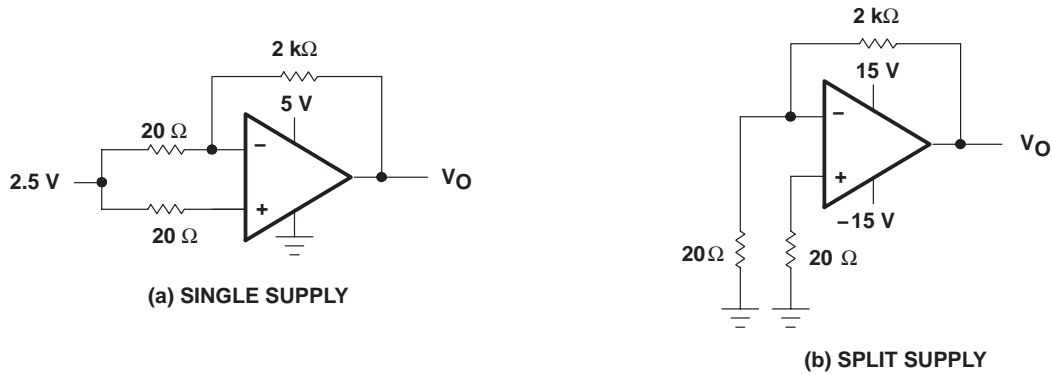
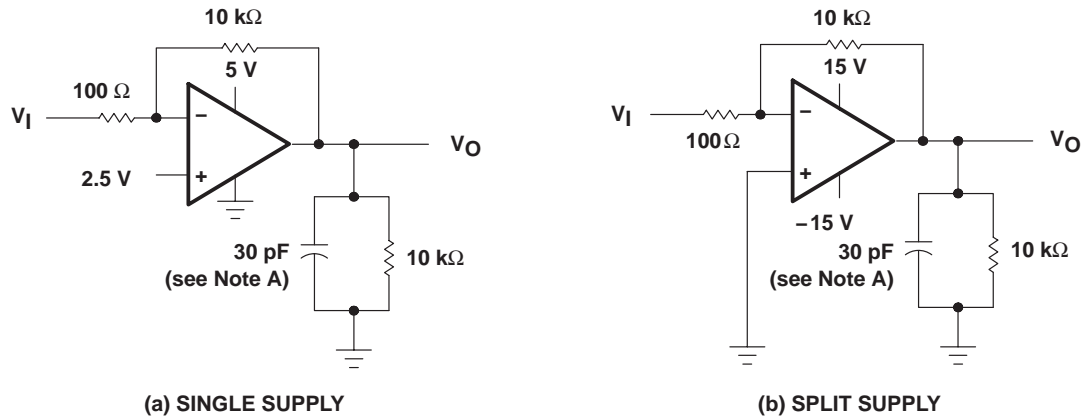

Figure 2. Noise-Voltage Test Circuit



NOTE A:  $C_L$  includes fixture capacitance.

Figure 3. Unity-Gain Bandwidth and Phase-Margin Test Circuit

# TLE202x, TLE202xA, TLE202xB, TLE202xY EXCALIBUR HIGH-SPEED LOW-POWER PRECISION OPERATIONAL AMPLIFIERS

SLOS191C – FEBRUARY 1997 – REVISED APRIL 2007

## PARAMETER MEASUREMENT INFORMATION

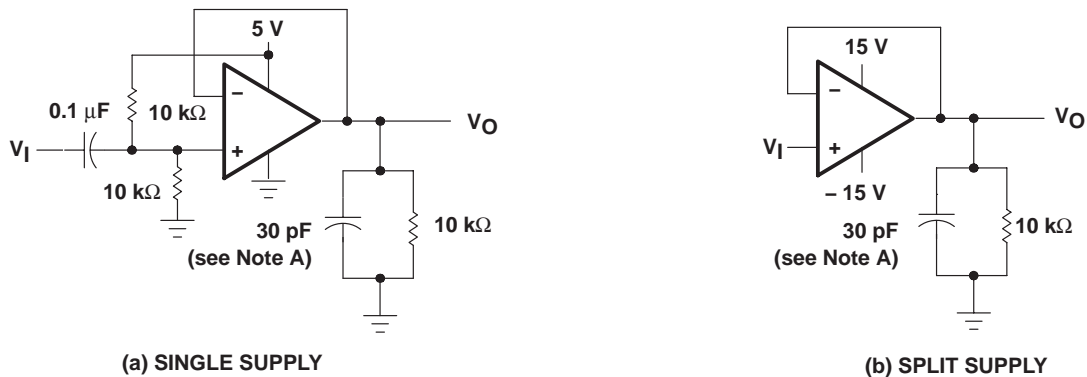

NOTE A:  $C_L$  includes fixture capacitance.

Figure 4. Small-Signal Pulse-Response Test Circuit

### typical values

Typical values presented in this data sheet represent the median (50% point) of device parametric performance.

**TLE202x, TLE202xA, TLE202xB, TLE202xY**  
**EXCALIBUR HIGH-SPEED LOW-POWER PRECISION**  
**OPERATIONAL AMPLIFIERS**

SLOS191C – FEBRUARY 1997 – REVISED APRIL 2007

**TYPICAL CHARACTERISTICS**

**Table of Graphs**

			<b>FIGURE</b>
$V_{IO}$	Input offset voltage	Distribution	5, 6, 7
$I_{IB}$	Input bias current	vs Common-mode input voltage vs Free-air temperature	8, 9, 10 11, 12, 13
$I_I$	Input current	vs Differential input voltage	14
$V_{OM}$	Maximum peak output voltage	vs Output current vs Free-air temperature	15, 16, 17 18
$V_{OH}$	High-level output voltage	vs High-level output current vs Free-air temperature	19, 20 21
$V_{OL}$	Low-level output voltage	vs Low-level output current vs Free-air temperature	22 23
$V_{O(PP)}$	Maximum peak-to-peak output voltage	vs Frequency	24, 25
$A_{VD}$	Large-signal differential voltage amplification	vs Frequency vs Free-air temperature	26 27, 28, 29
$I_{OS}$	Short-circuit output current	vs Supply voltage vs Free-air temperature	30 – 33 34 – 37
$I_{CC}$	Supply current	vs Supply voltage vs Free-air temperature	38, 39, 40 41, 42, 43
CMRR	Common-mode rejection ratio	vs Frequency	44, 45, 46
SR	Slew rate	vs Free-air temperature	47, 48, 49
	Voltage-follower small-signal pulse response		50, 51
	Voltage-follower large-signal pulse response		52 – 57
$V_{N(PP)}$	Peak-to-peak equivalent input noise voltage	0.1 to 1 Hz 0.1 to 10 Hz	58 59
$V_n$	Equivalent input noise voltage	vs Frequency	60
$B_1$	Unity-gain bandwidth	vs Supply voltage vs Free-air temperature	61, 62 63, 64
$\phi_m$	Phase margin	vs Supply voltage vs Load capacitance vs Free-air temperature	65, 66 67, 68 69, 70
	Phase shift	vs Frequency	26

# TLE202x, TLE202xA, TLE202xB, TLE202xY EXCALIBUR HIGH-SPEED LOW-POWER PRECISION OPERATIONAL AMPLIFIERS

SLOS191C – FEBRUARY 1997 – REVISED APRIL 2007

## TYPICAL CHARACTERISTICS

DISTRIBUTION OF TLE2021  
INPUT OFFSET VOLTAGE

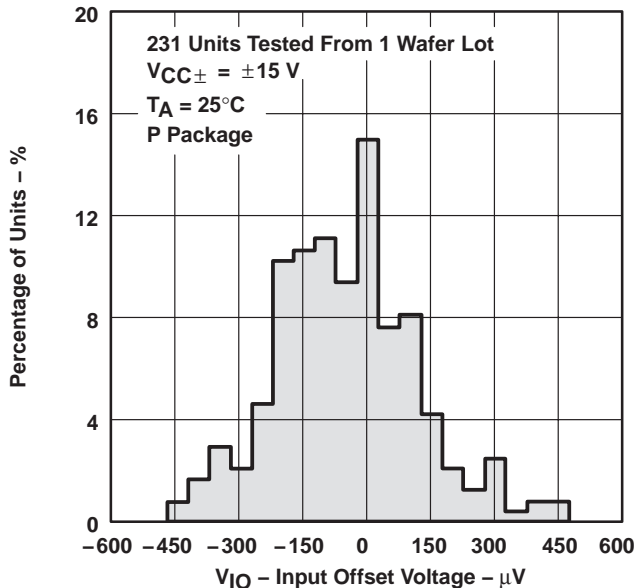

Figure 5

DISTRIBUTION OF TLE2022  
INPUT OFFSET VOLTAGE

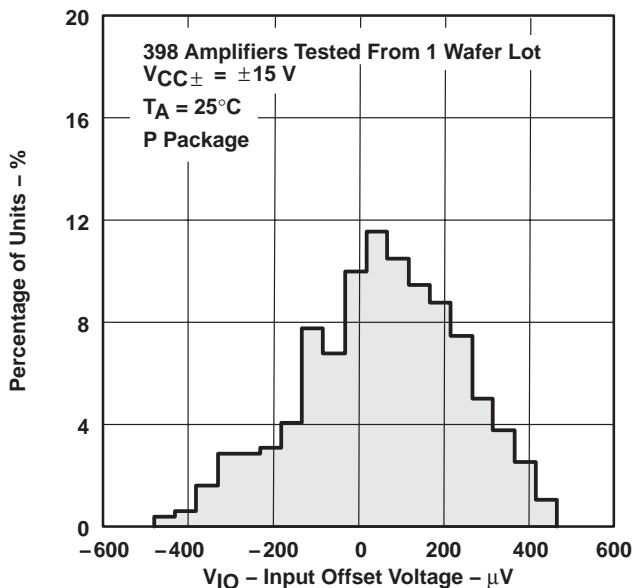

Figure 6

DISTRIBUTION OF TLE2024  
INPUT OFFSET VOLTAGE

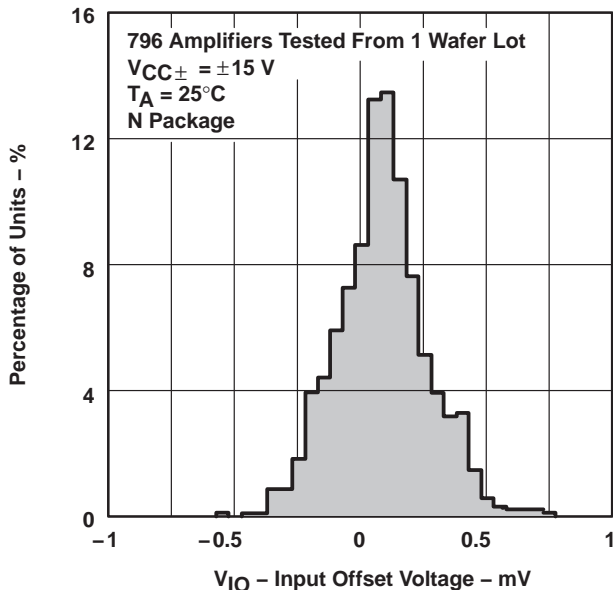

Figure 7

TLE2021  
INPUT BIAS CURRENT  
vs

COMMON-MODE INPUT VOLTAGE

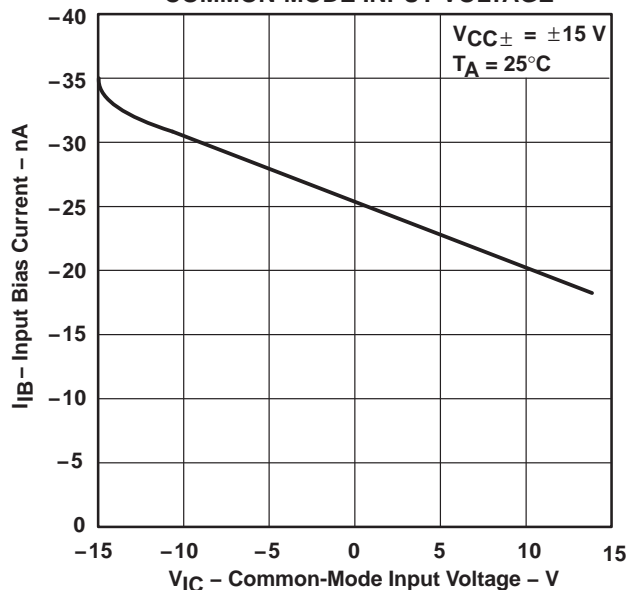
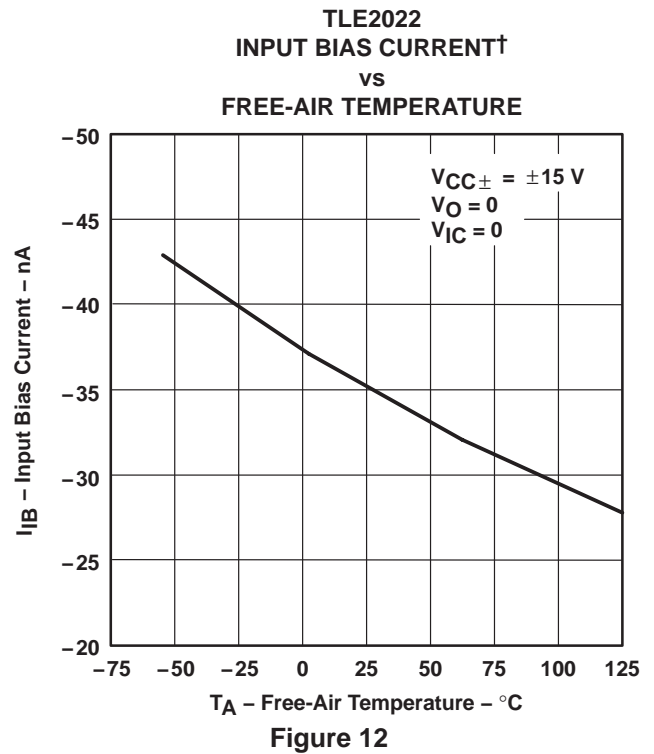
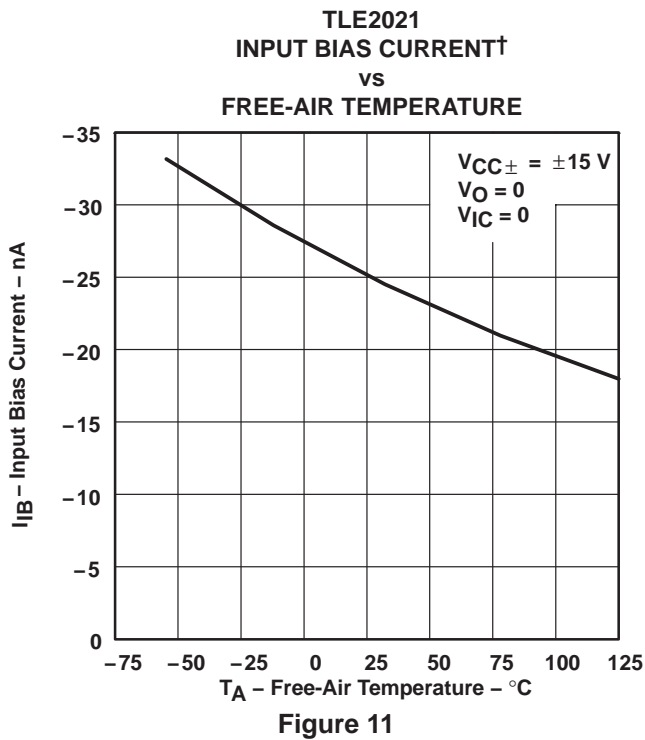
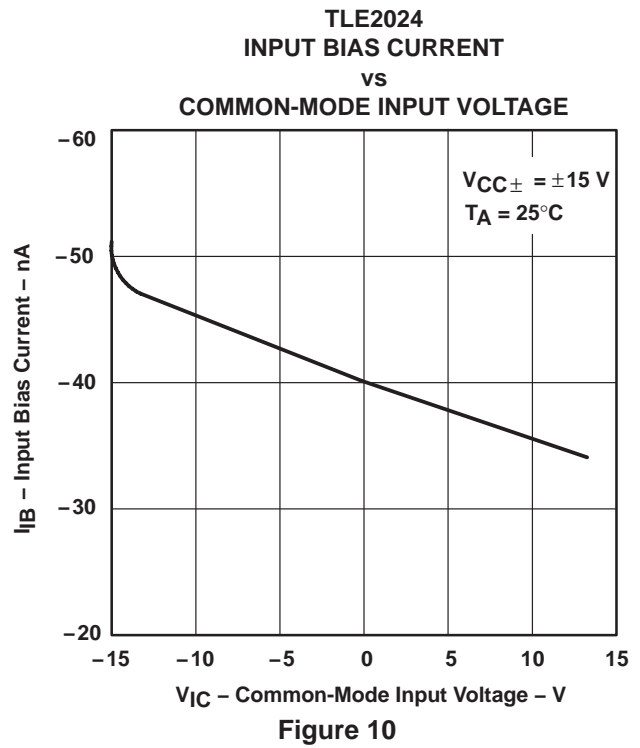
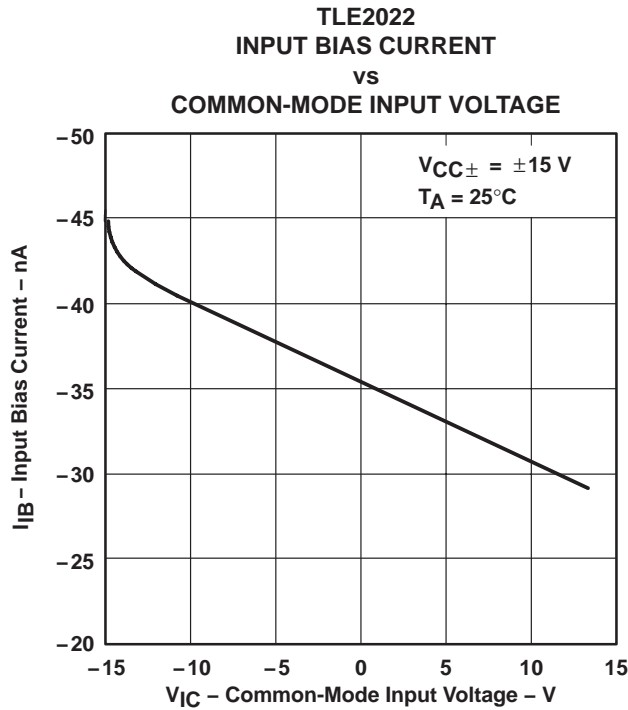

Figure 8

# TLE202x, TLE202xA, TLE202xB, TLE202xY EXCALIBUR HIGH-SPEED LOW-POWER PRECISION OPERATIONAL AMPLIFIERS

SLOS191C – FEBRUARY 1997 – REVISED APRIL 2007

## TYPICAL CHARACTERISTICS



† Data at high and low temperatures are applicable only within the rated operating free-air temperature ranges of the various devices.

# TLE202x, TLE202xA, TLE202xB, TLE202xY EXCALIBUR HIGH-SPEED LOW-POWER PRECISION OPERATIONAL AMPLIFIERS

SLOS191C – FEBRUARY 1997 – REVISED APRIL 2007

## TYPICAL CHARACTERISTICS

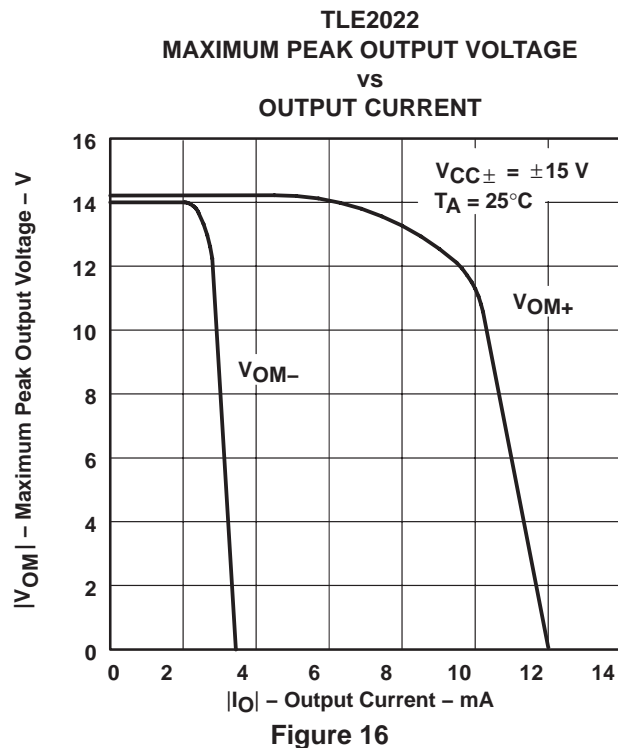
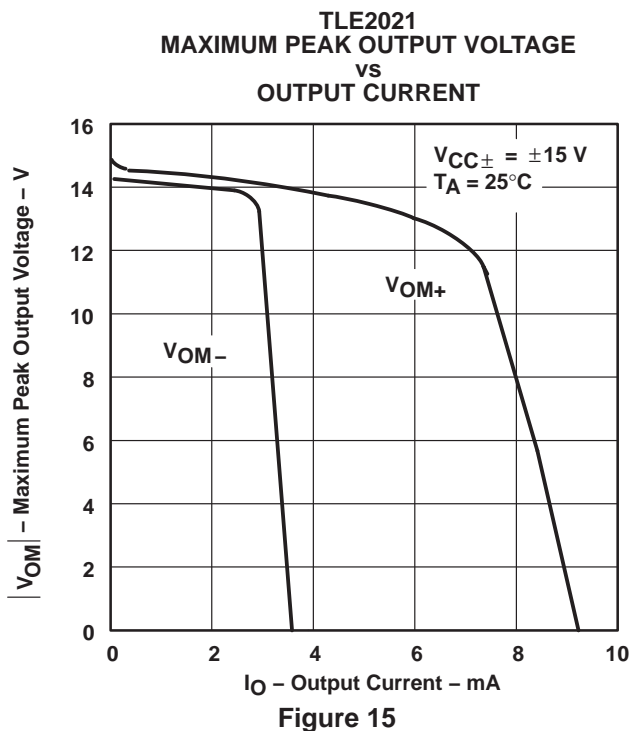
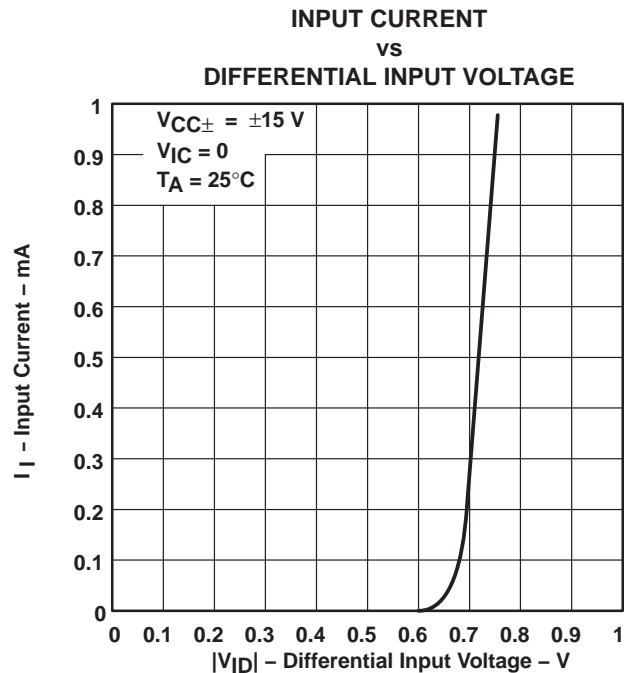
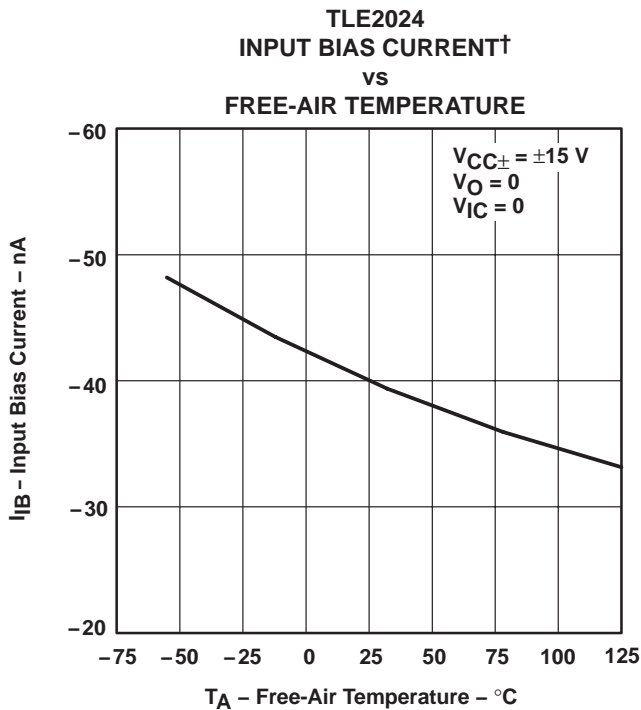

† Data at high and low temperatures are applicable only within the rated operating free-air temperature ranges of the various devices.

# TLE202x, TLE202xA, TLE202xB, TLE202xY EXCALIBUR HIGH-SPEED LOW-POWER PRECISION OPERATIONAL AMPLIFIERS

SLOS191C – FEBRUARY 1997 – REVISED APRIL 2007

## TYPICAL CHARACTERISTICS

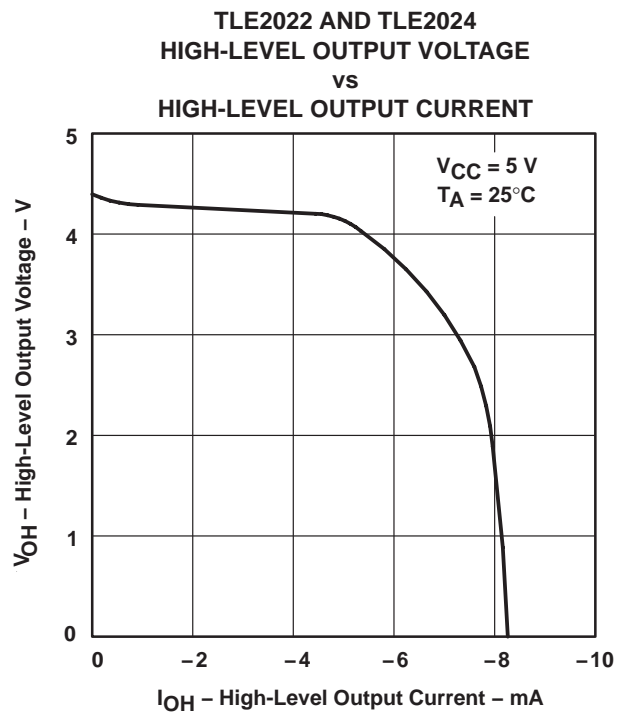
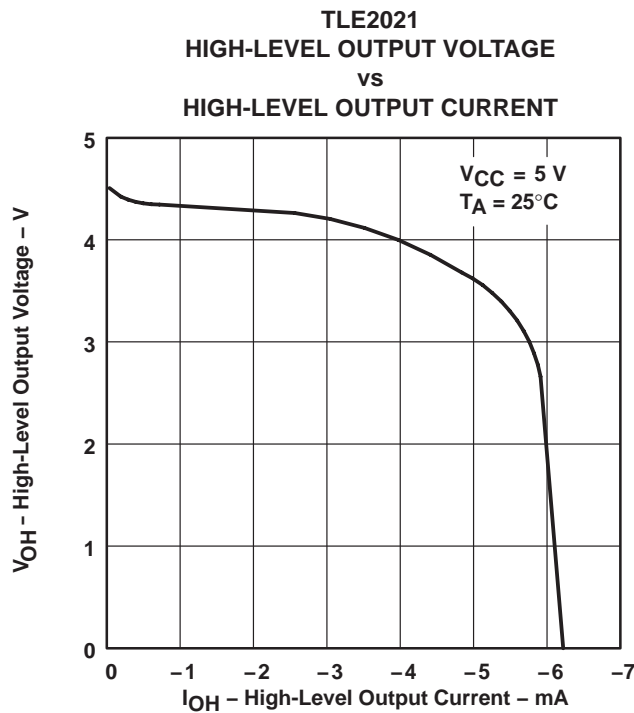
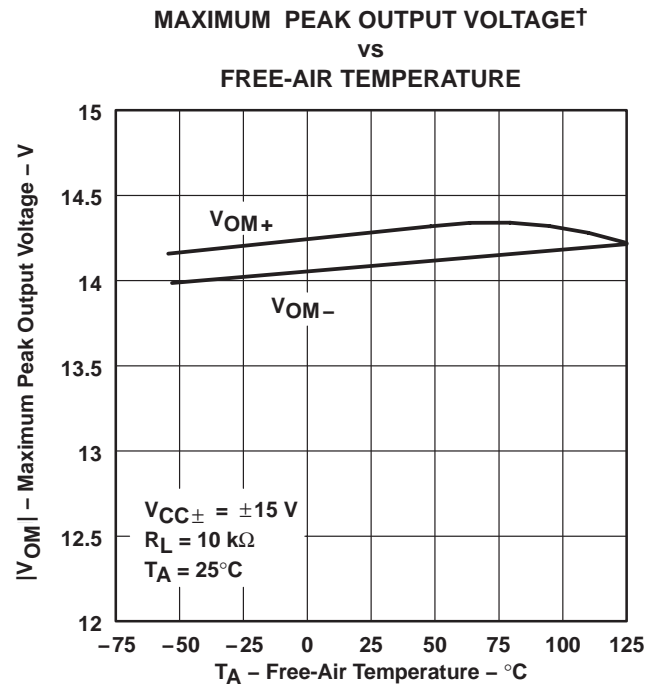
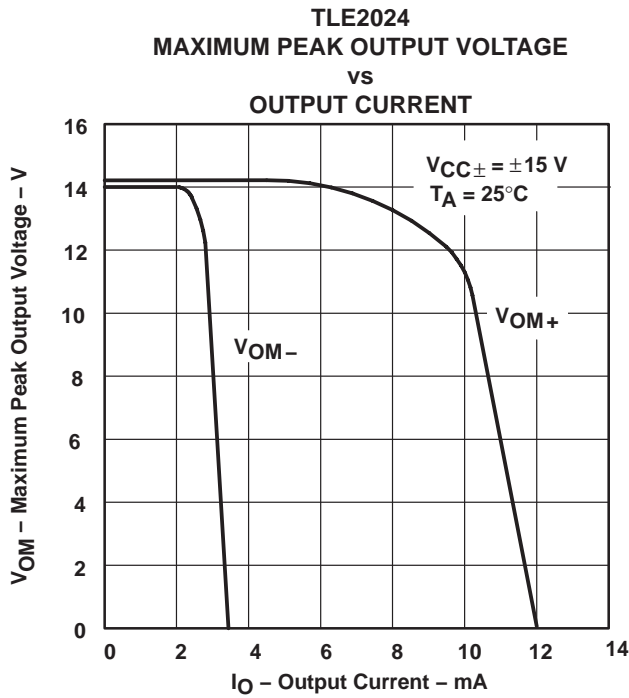

† Data at high and low temperatures are applicable only within the rated operating free-air temperature ranges of the various devices.

# TLE202x, TLE202xA, TLE202xB, TLE202xY EXCALIBUR HIGH-SPEED LOW-POWER PRECISION OPERATIONAL AMPLIFIERS

SLOS191C – FEBRUARY 1997 – REVISED APRIL 2007

## TYPICAL CHARACTERISTICS

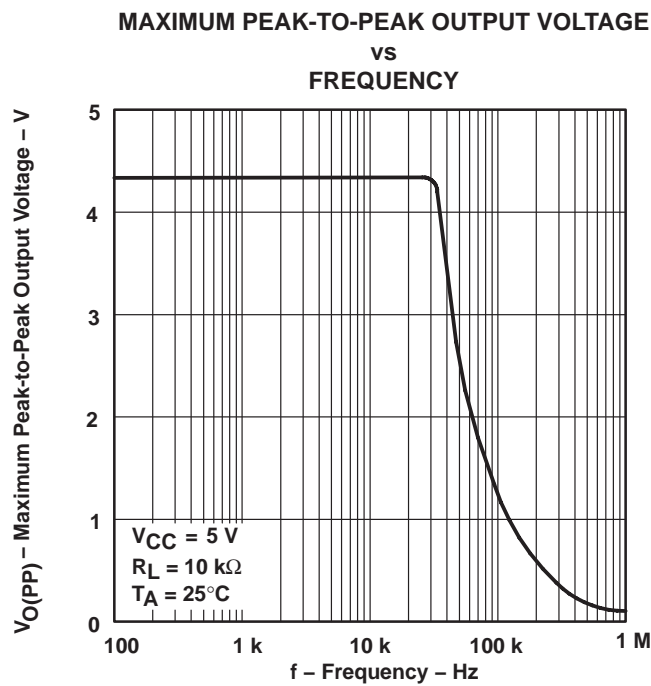
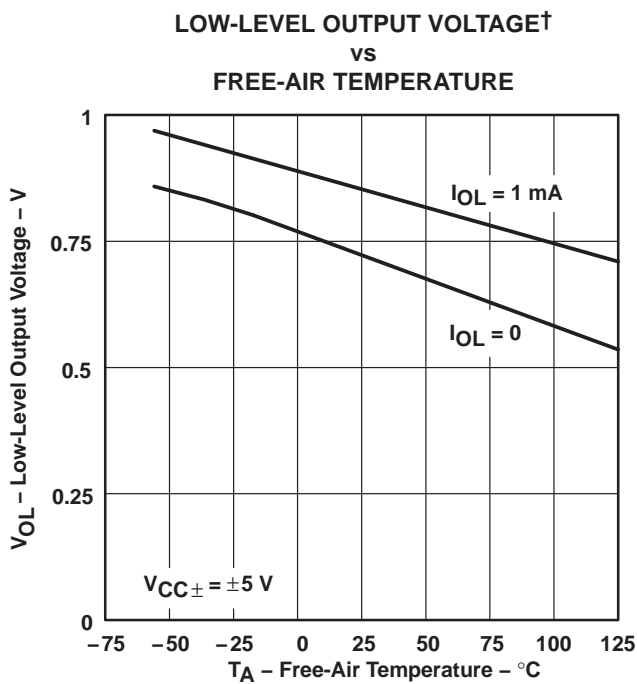
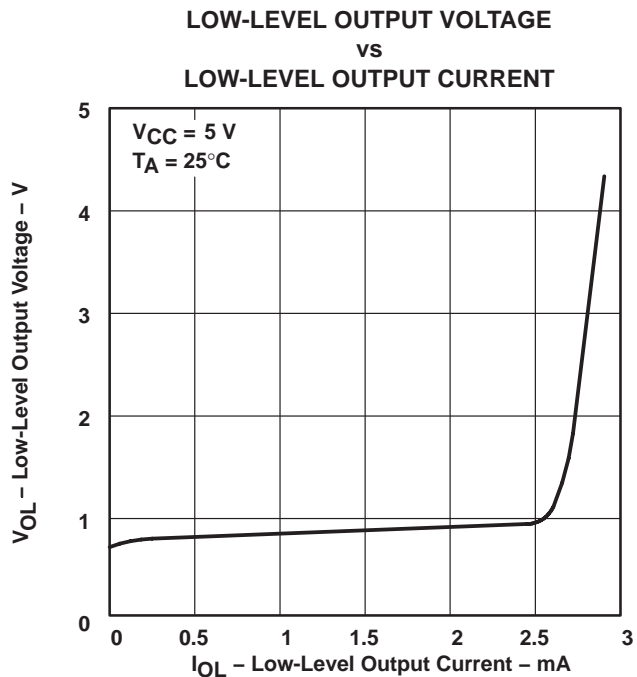
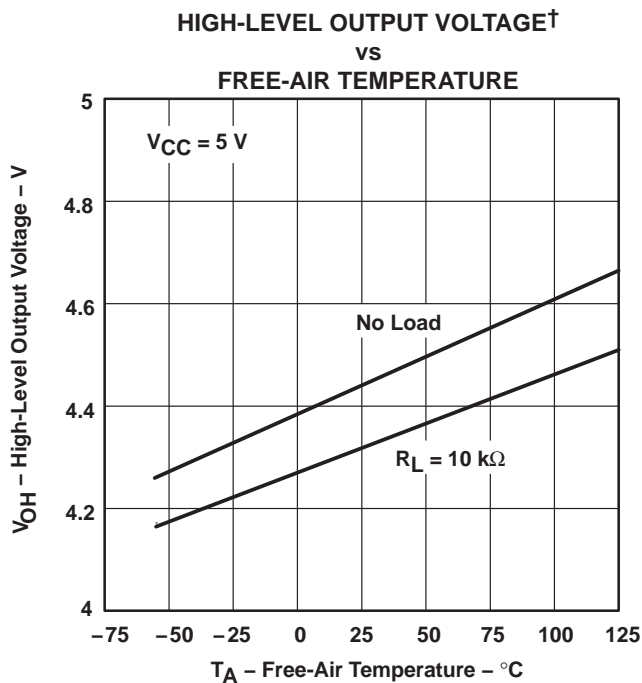

† Data at high and low temperatures are applicable only within the rated operating free-air temperature ranges of the various devices.



# TLE202x, TLE202xA, TLE202xB, TLE202xY EXCALIBUR HIGH-SPEED LOW-POWER PRECISION OPERATIONAL AMPLIFIERS

SLOS191C – FEBRUARY 1997 – REVISED APRIL 2007

## TYPICAL CHARACTERISTICS

### MAXIMUM PEAK-TO-PEAK OUTPUT VOLTAGE vs FREQUENCY

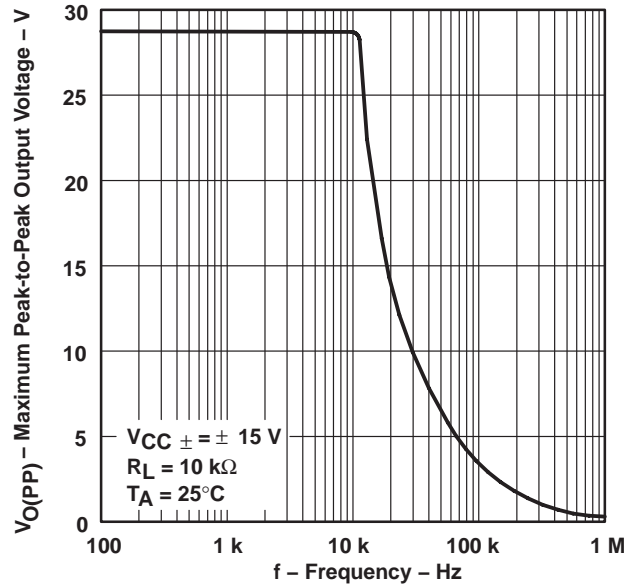

Figure 25

### LARGE-SIGNAL DIFFERENTIAL VOLTAGE AMPLIFICATION AND PHASE SHIFT vs FREQUENCY

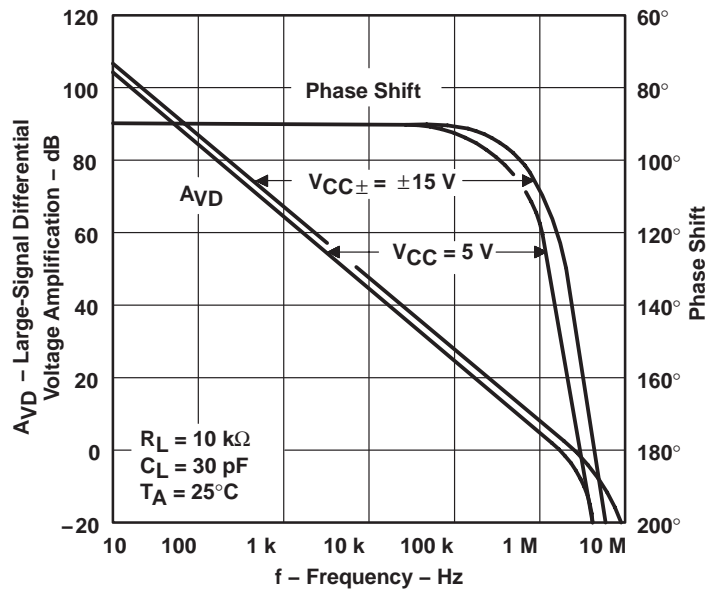
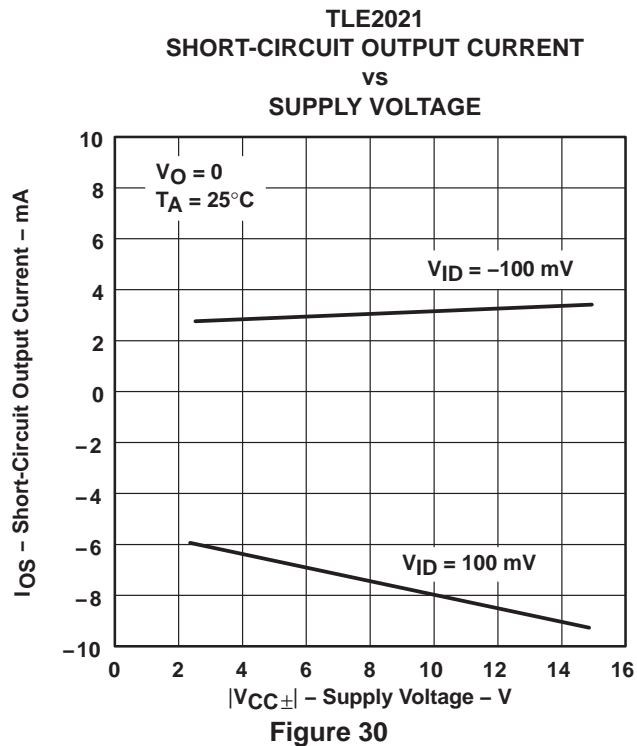
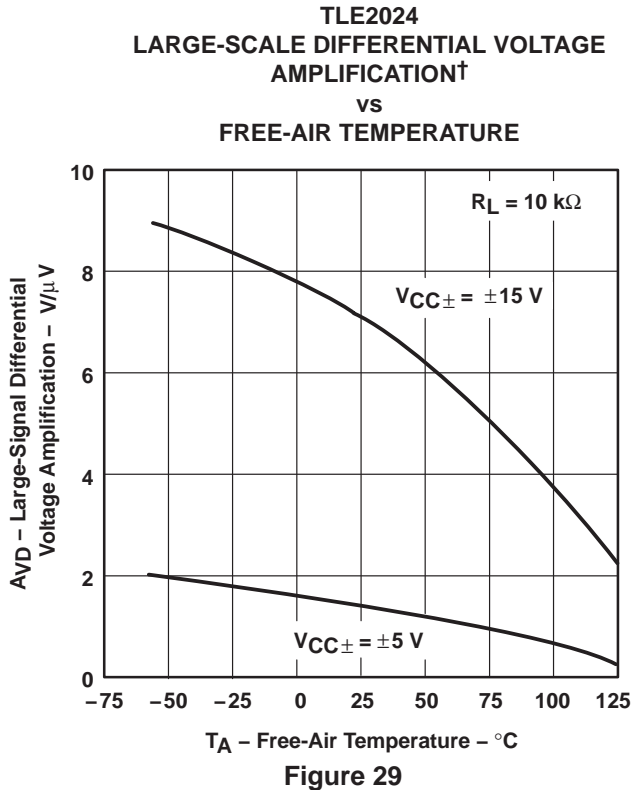
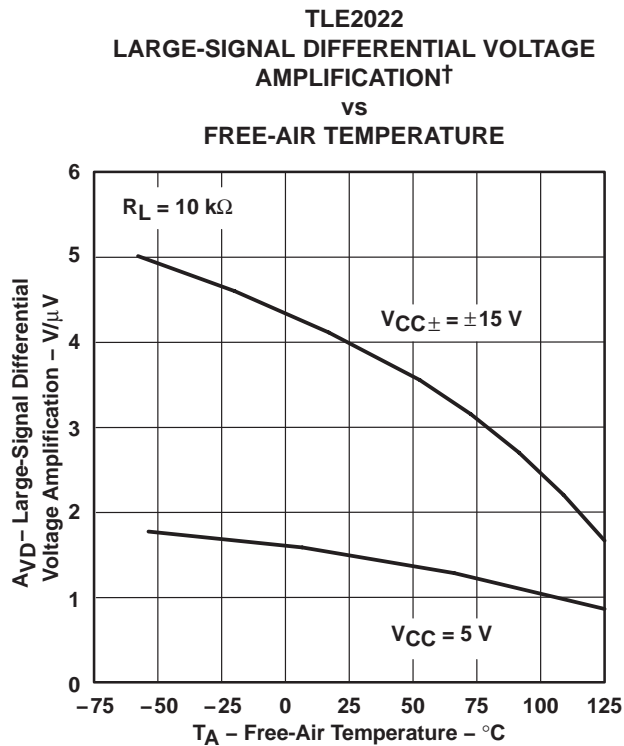
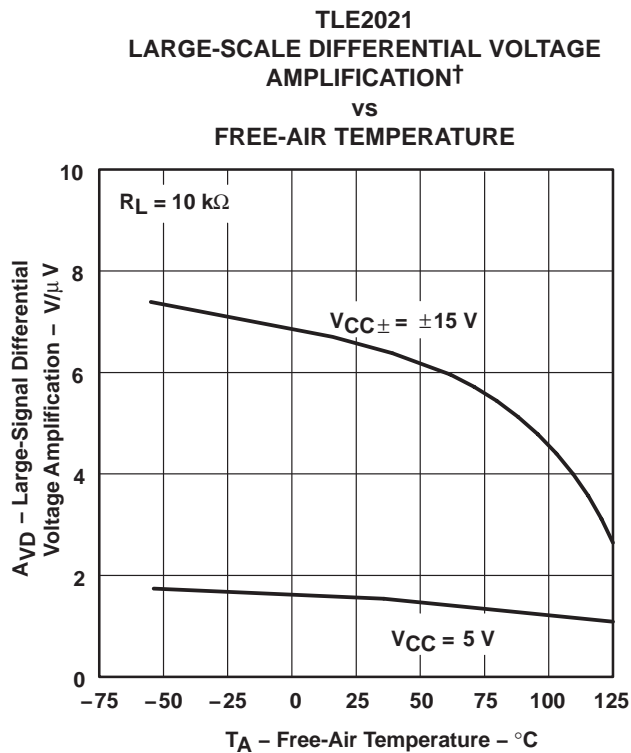

Figure 26

# TLE202x, TLE202xA, TLE202xB, TLE202xY EXCALIBUR HIGH-SPEED LOW-POWER PRECISION OPERATIONAL AMPLIFIERS

SLOS191C – FEBRUARY 1997 – REVISED APRIL 2007

## TYPICAL CHARACTERISTICS



† Data at high and low temperatures are applicable only within the rated operating free-air temperature ranges of the various devices.

# TLE202x, TLE202xA, TLE202xB, TLE202xY EXCALIBUR HIGH-SPEED LOW-POWER PRECISION OPERATIONAL AMPLIFIERS

SLOS191C – FEBRUARY 1997 – REVISED APRIL 2007

## TYPICAL CHARACTERISTICS

TLE2022 AND TLE2024  
SHORT-CIRCUIT OUTPUT CURRENT  
vs  
SUPPLY VOLTAGE

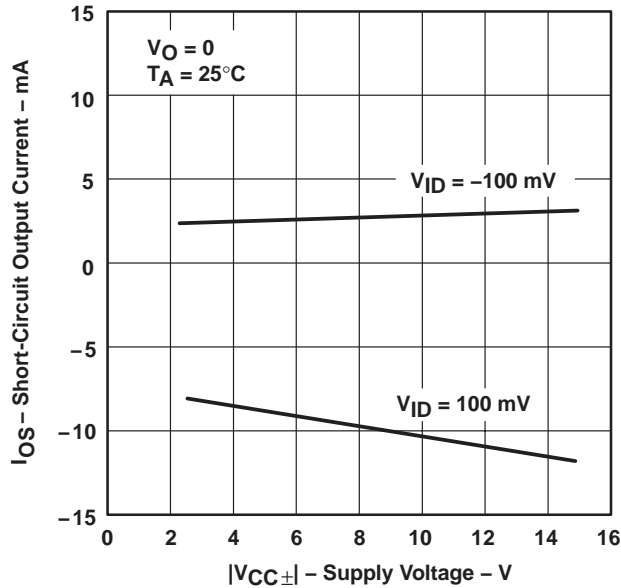

Figure 31

TLE2021  
SHORT-CIRCUIT OUTPUT CURRENT  
vs  
SUPPLY VOLTAGE

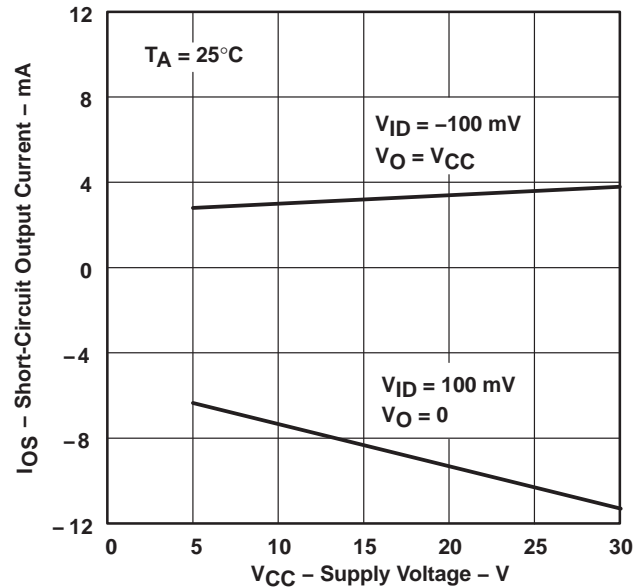

Figure 32

TLE2022 AND TLE2024  
SHORT-CIRCUIT OUTPUT CURRENT  
vs  
SUPPLY VOLTAGE

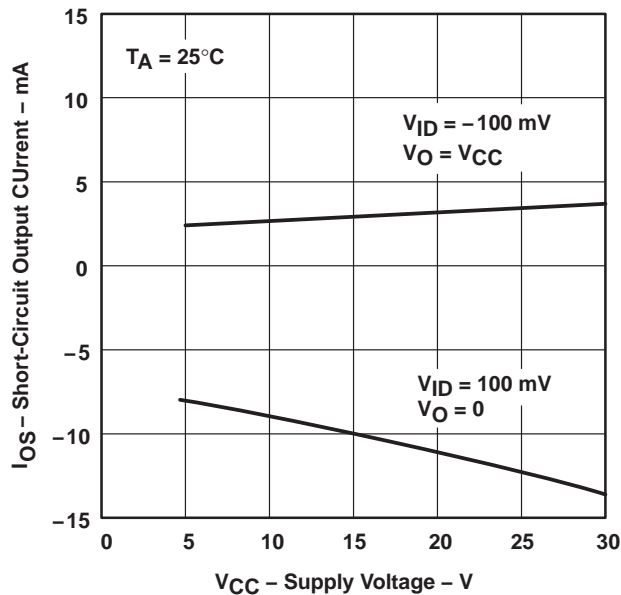

Figure 33

TLE2021  
SHORT-CIRCUIT OUTPUT CURRENT†  
vs  
FREE-AIR TEMPERATURE

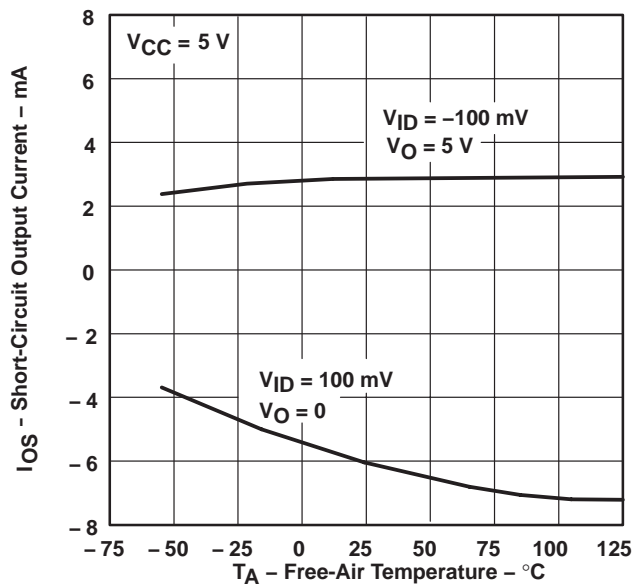

Figure 34

† Data at high and low temperatures are applicable only within the rated operating free-air temperature ranges of the various devices.

# TLE202x, TLE202xA, TLE202xB, TLE202xY EXCALIBUR HIGH-SPEED LOW-POWER PRECISION OPERATIONAL AMPLIFIERS

SLOS191C – FEBRUARY 1997 – REVISED APRIL 2007

## TYPICAL CHARACTERISTICS

TLE2022 AND TLE2024  
SHORT-CIRCUIT OUTPUT CURRENT†  
vs  
FREE-AIR TEMPERATURE

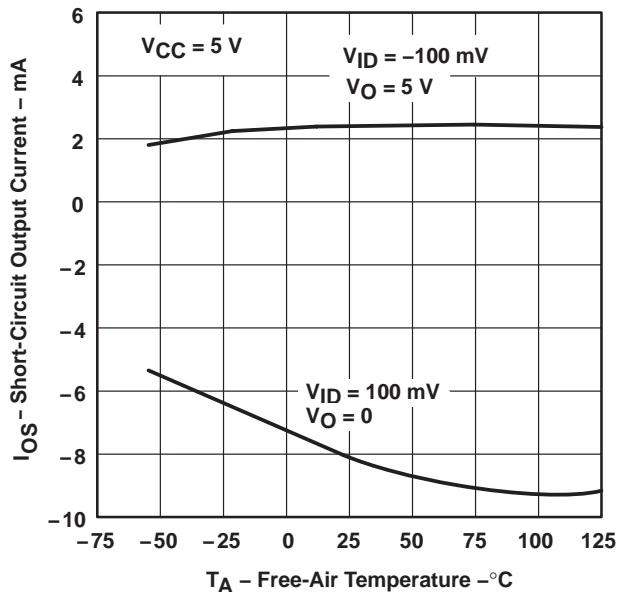

Figure 35

TLE2021  
SHORT-CIRCUIT OUTPUT CURRENT†  
vs  
FREE-AIR TEMPERATURE

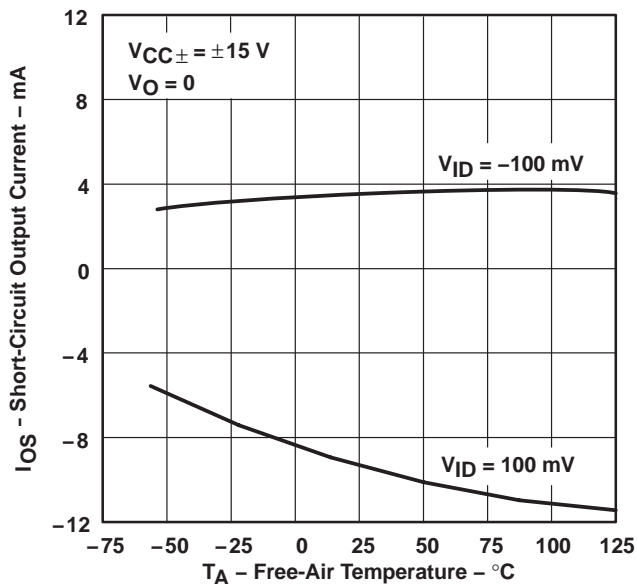

Figure 36

TLE2022 AND TLE2024  
SHORT-CIRCUIT OUTPUT CURRENT†  
vs  
FREE-AIR TEMPERATURE

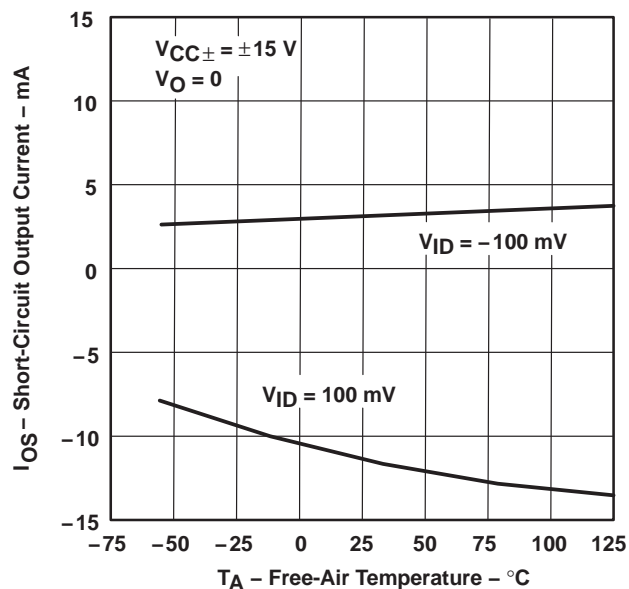

Figure 37

TLE2021  
SUPPLY CURRENT  
vs  
SUPPLY VOLTAGE

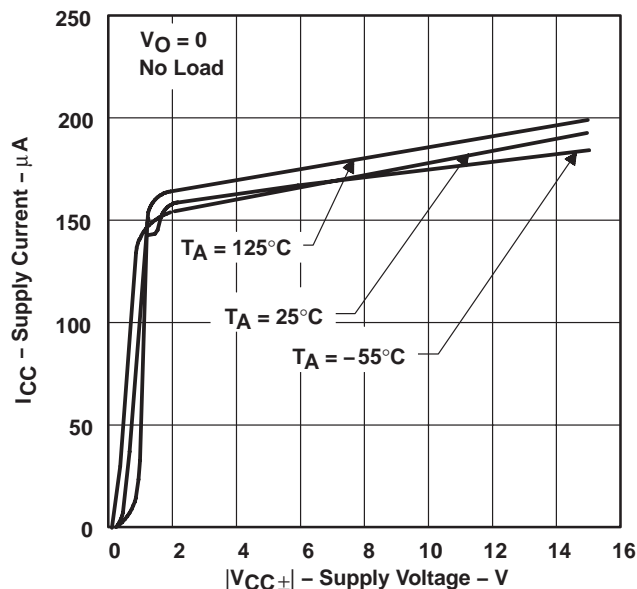

Figure 38

† Data at high and low temperatures are applicable only within the rated operating free-air temperature ranges of the various devices.

# TLE202x, TLE202xA, TLE202xB, TLE202xY EXCALIBUR HIGH-SPEED LOW-POWER PRECISION OPERATIONAL AMPLIFIERS

SLOS191C – FEBRUARY 1997 – REVISED APRIL 2007

## TYPICAL CHARACTERISTICS

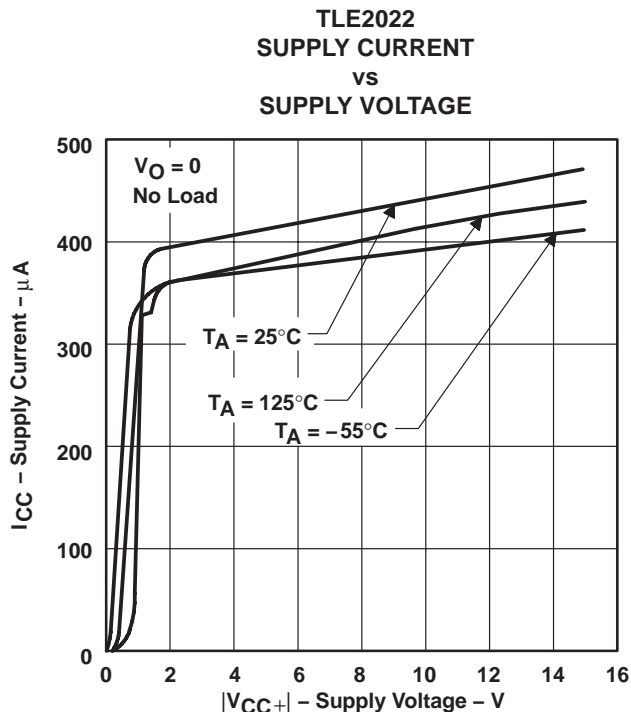

Figure 39

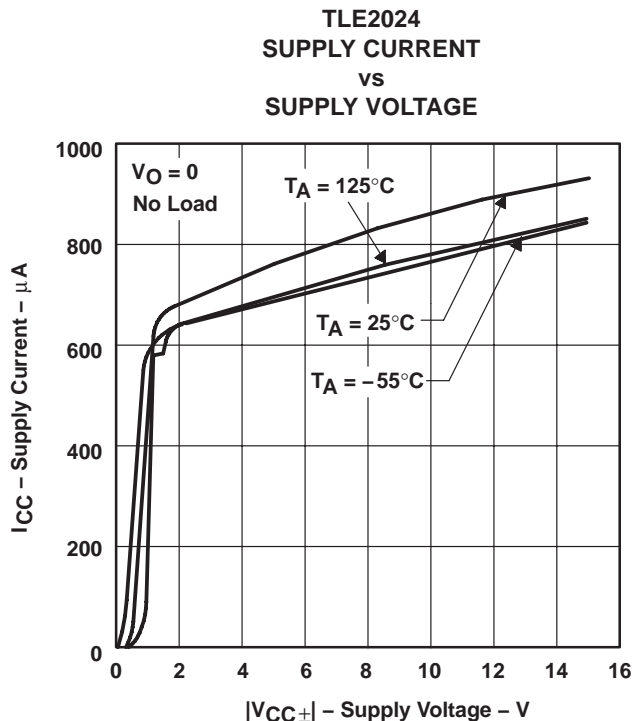

Figure 40

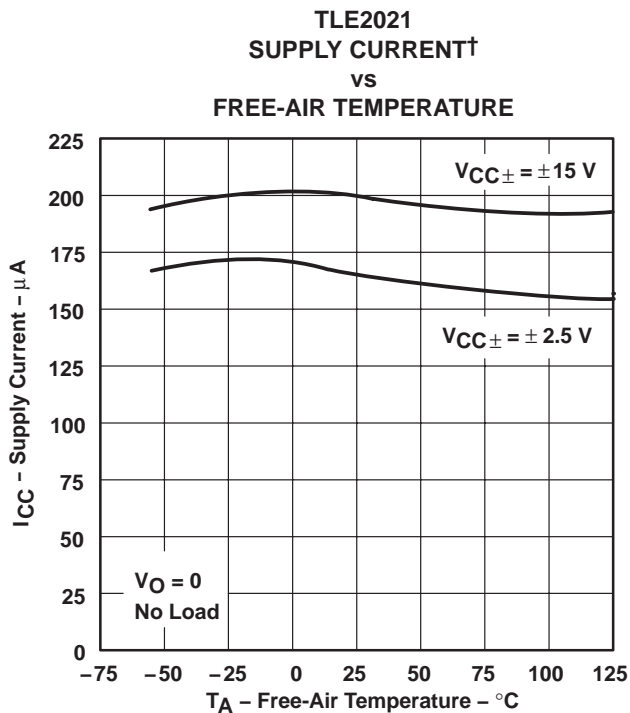

Figure 41

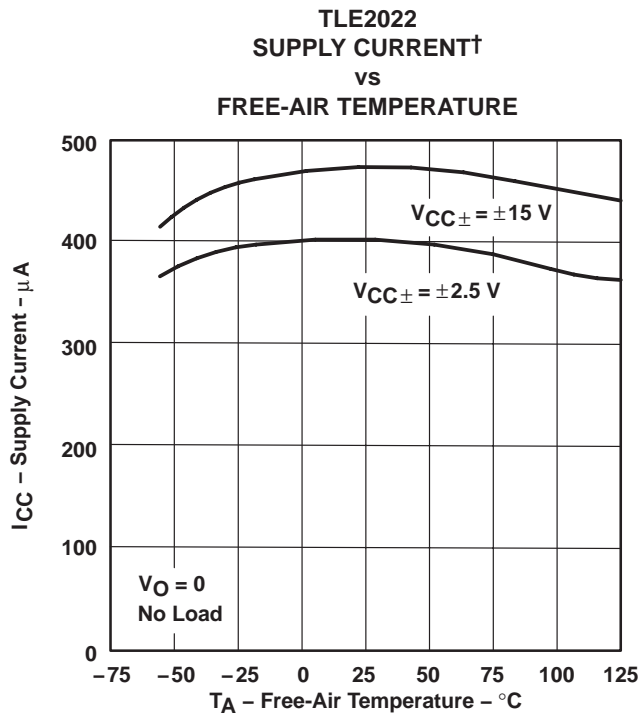

Figure 42

† Data at high and low temperatures are applicable only within the rated operating free-air temperature ranges of the various devices.

# TLE202x, TLE202xA, TLE202xB, TLE202xY EXCALIBUR HIGH-SPEED LOW-POWER PRECISION OPERATIONAL AMPLIFIERS

SLOS191C – FEBRUARY 1997 – REVISED APRIL 2007

## TYPICAL CHARACTERISTICS

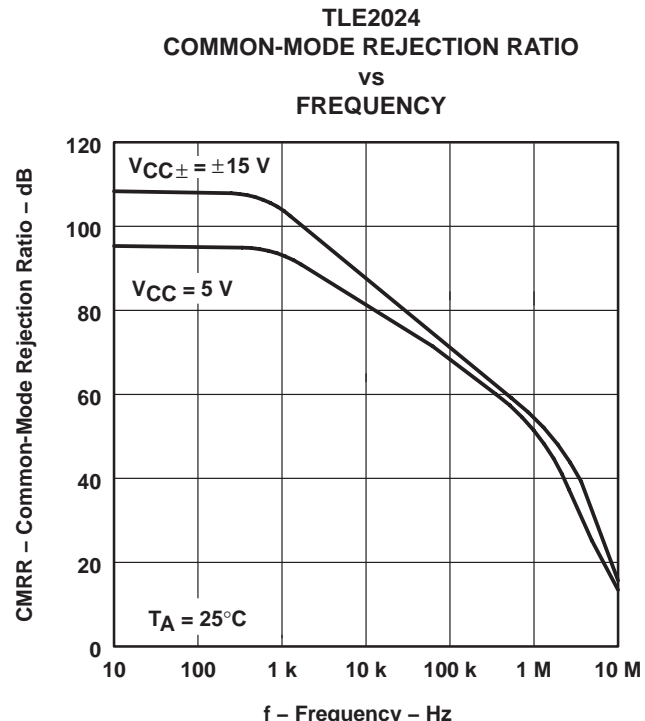
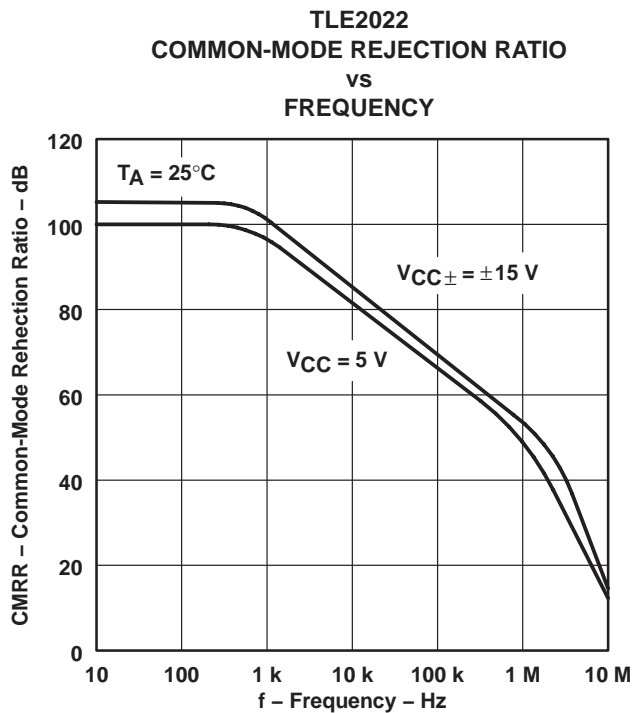
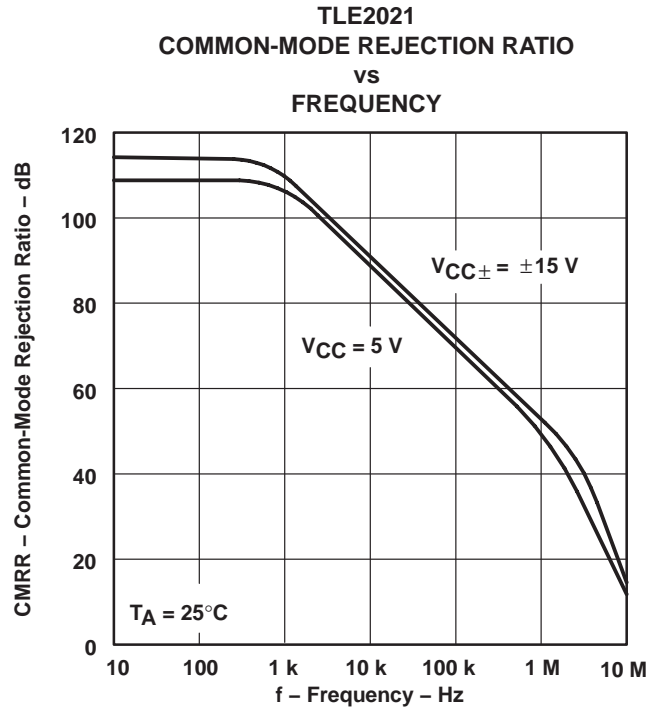
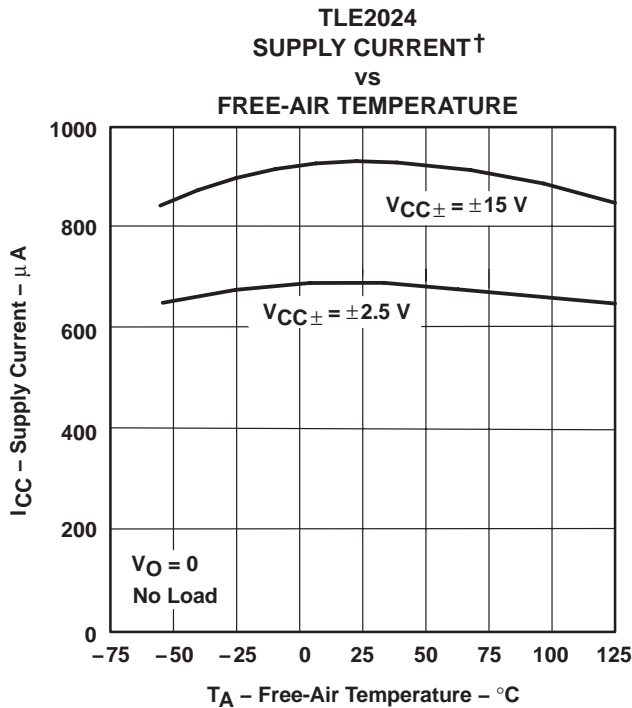

† Data at high and low temperatures are applicable only within the rated operating free-air temperature ranges of the various devices.

# TLE202x, TLE202xA, TLE202xB, TLE202xY EXCALIBUR HIGH-SPEED LOW-POWER PRECISION OPERATIONAL AMPLIFIERS

SLOS191C – FEBRUARY 1997 – REVISED APRIL 2007

## TYPICAL CHARACTERISTICS

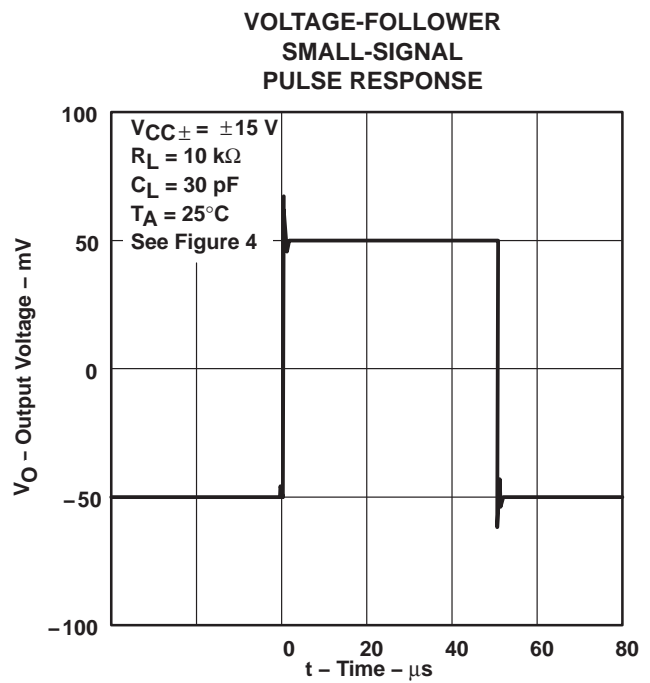
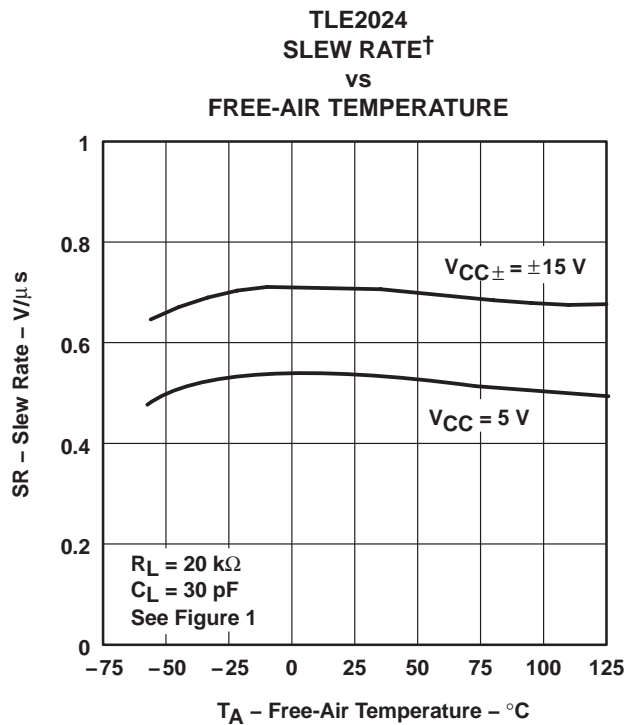
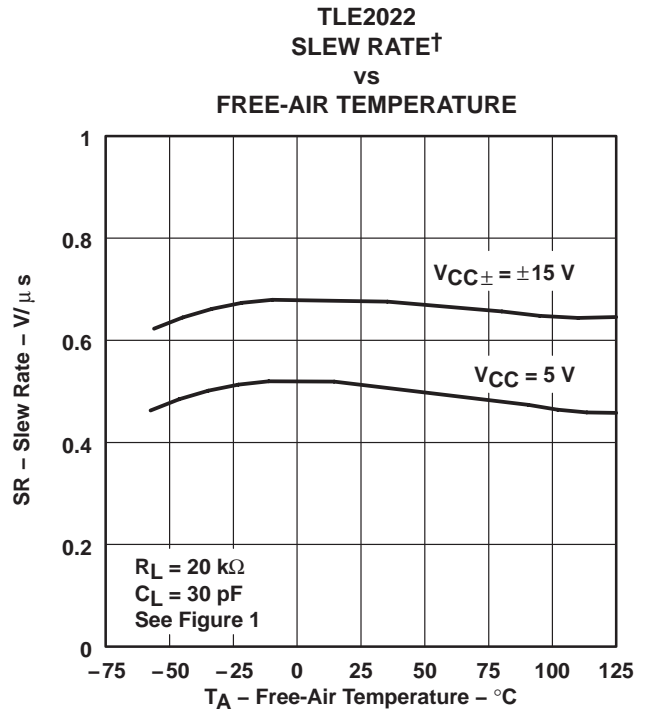
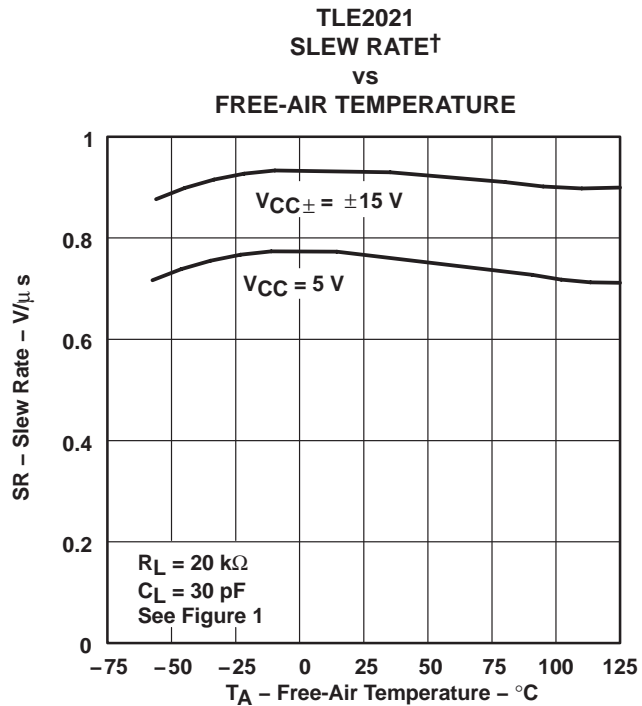

† Data at high and low temperatures are applicable only within the rated operating free-air temperature ranges of the various devices.

# TLE202x, TLE202xA, TLE202xB, TLE202xY EXCALIBUR HIGH-SPEED LOW-POWER PRECISION OPERATIONAL AMPLIFIERS

SLOS191C – FEBRUARY 1997 – REVISED APRIL 2007

## TYPICAL CHARACTERISTICS

**VOLTAGE-FOLLOWER  
SMALL-SIGNAL  
PULSE RESPONSE**

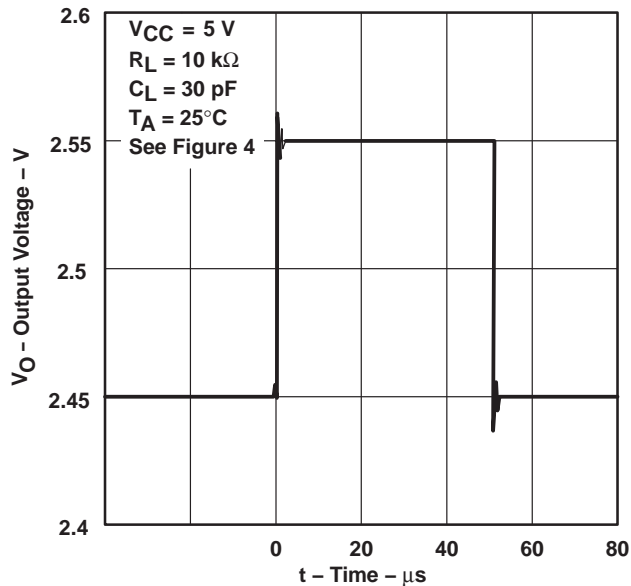

**Figure 51**

**TLE2021  
VOLTAGE-FOLLOWER LARGE-SIGNAL  
PULSE RESPONSE**

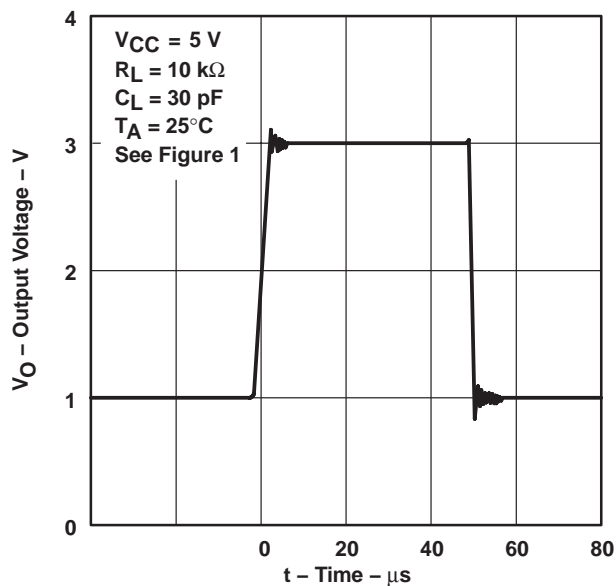

**Figure 52**

**TLE2022  
VOLTAGE-FOLLOWER LARGE-SIGNAL  
PULSE RESPONSE**

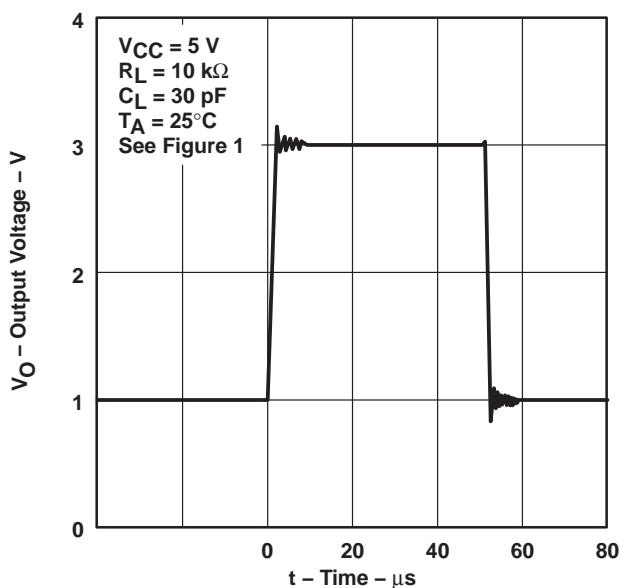

**Figure 53**

**TLE2024  
VOLTAGE-FOLLOWER LARGE-SCALE  
PULSE RESPONSE**

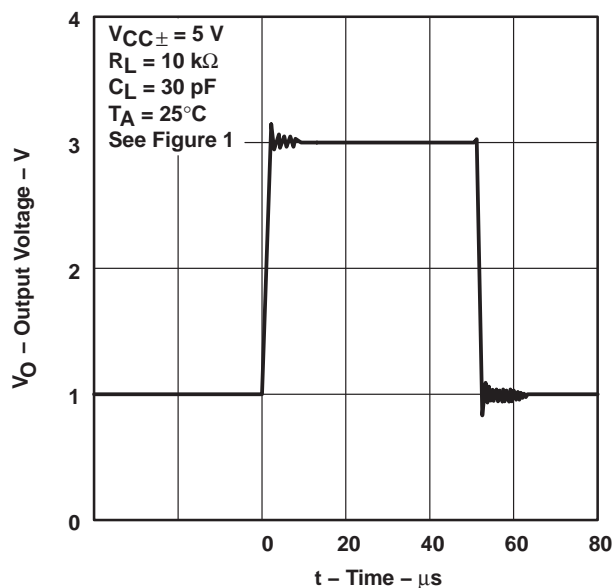

**Figure 54**





# TLE202x, TLE202xA, TLE202xB, TLE202xY EXCALIBUR HIGH-SPEED LOW-POWER PRECISION OPERATIONAL AMPLIFIERS

SLOS191C – FEBRUARY 1997 – REVISED APRIL 2007

## TYPICAL CHARACTERISTICS

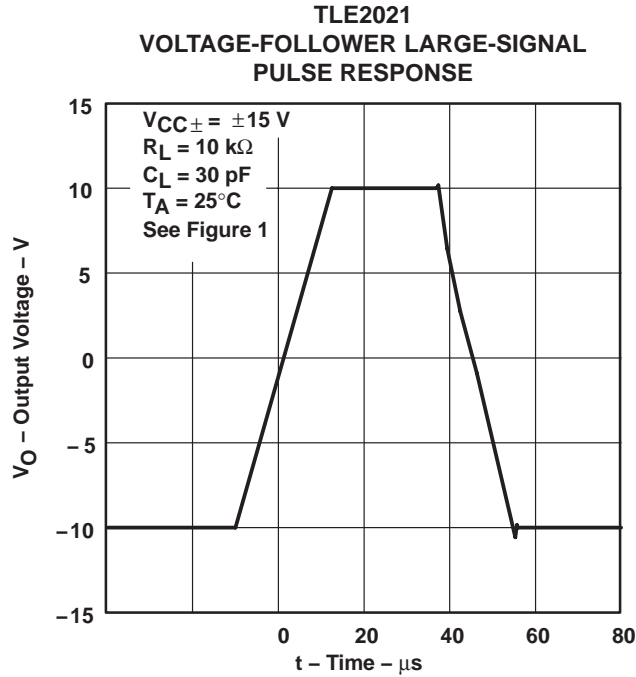

Figure 55

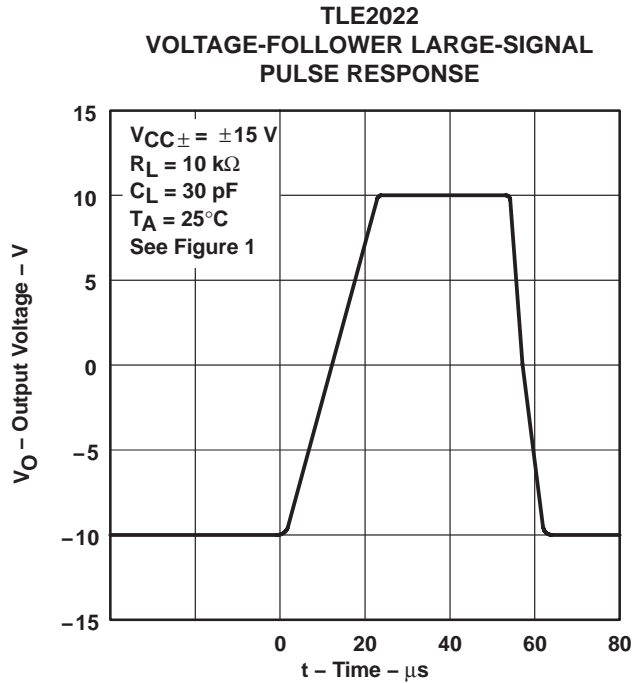

Figure 56

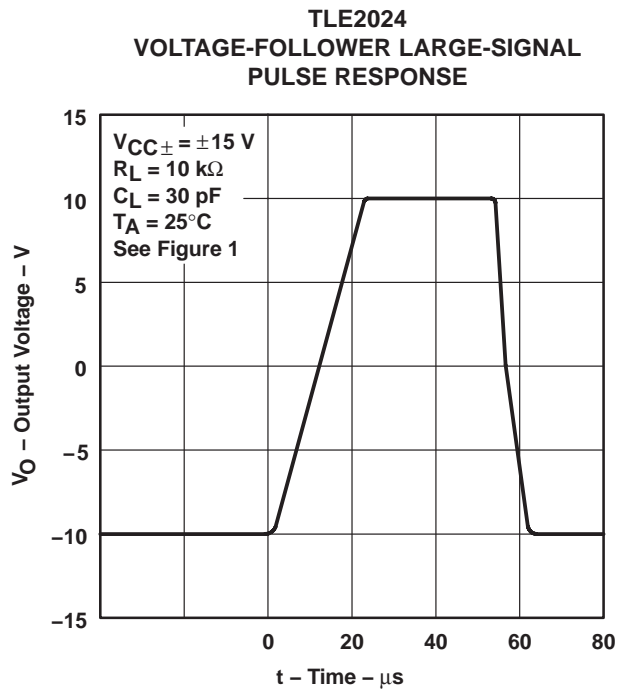

Figure 57

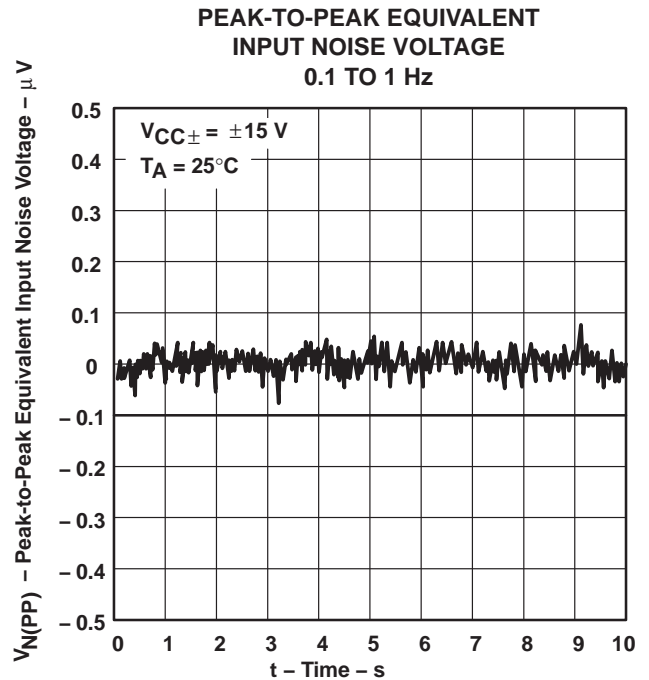
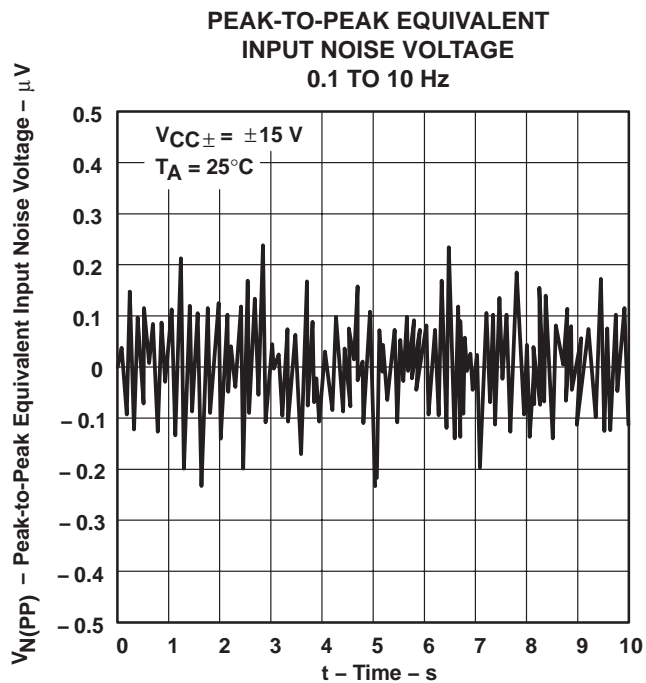

Figure 58

**TLE202x, TLE202xA, TLE202xB, TLE202xY**  
**EXCALIBUR HIGH-SPEED LOW-POWER PRECISION**  
**OPERATIONAL AMPLIFIERS**

SLOS191C – FEBRUARY 1997 – REVISED APRIL 2007

**TYPICAL CHARACTERISTICS**



**Figure 59**

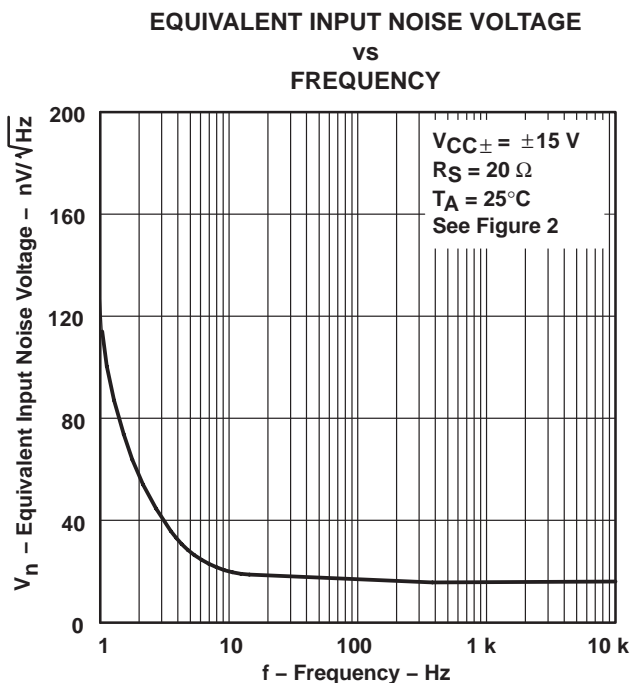

**Figure 60**

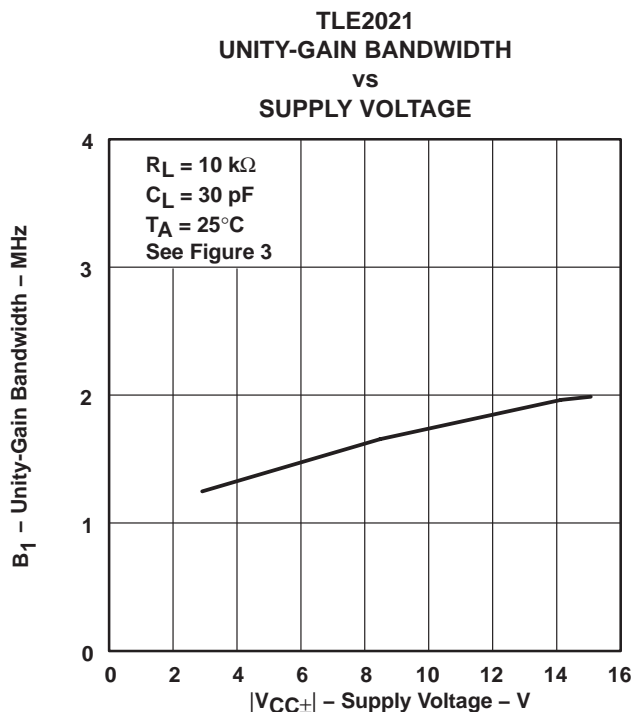

**Figure 61**

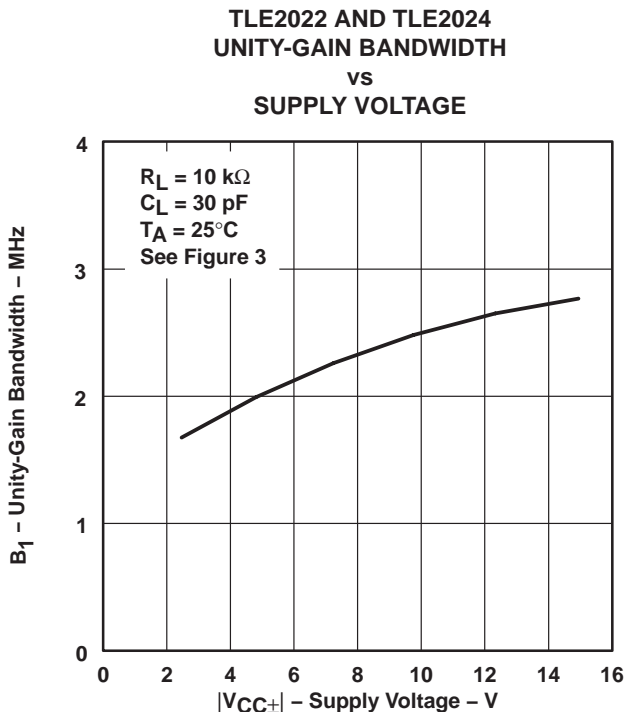

**Figure 62**



# TLE202x, TLE202xA, TLE202xB, TLE202xY EXCALIBUR HIGH-SPEED LOW-POWER PRECISION OPERATIONAL AMPLIFIERS

SLOS191C – FEBRUARY 1997 – REVISED APRIL 2007

## TYPICAL CHARACTERISTICS

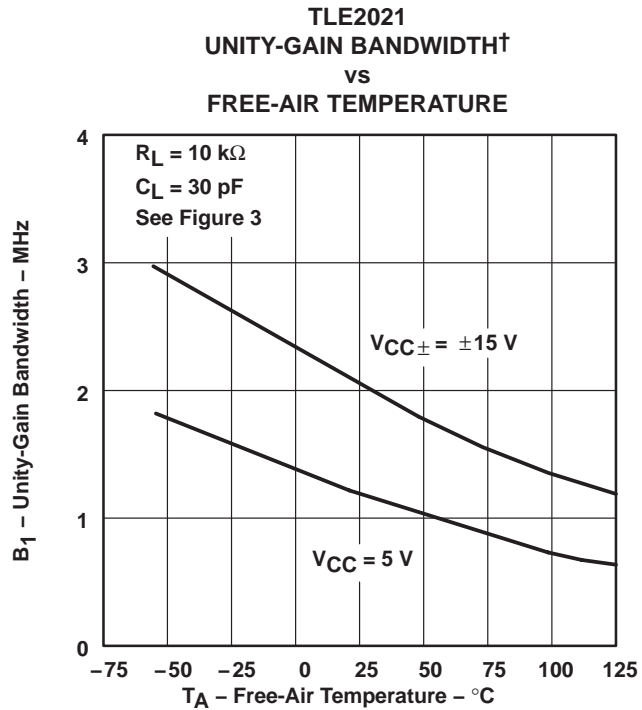

Figure 63

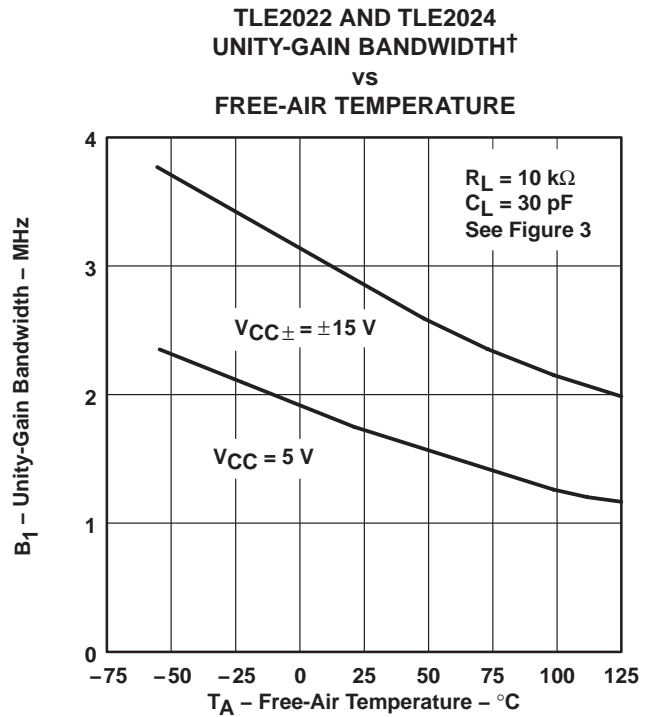

Figure 64

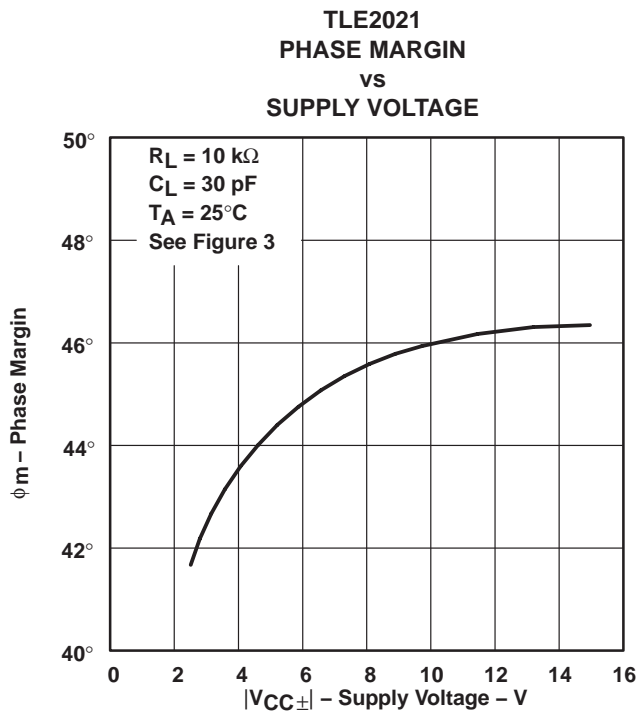

Figure 65

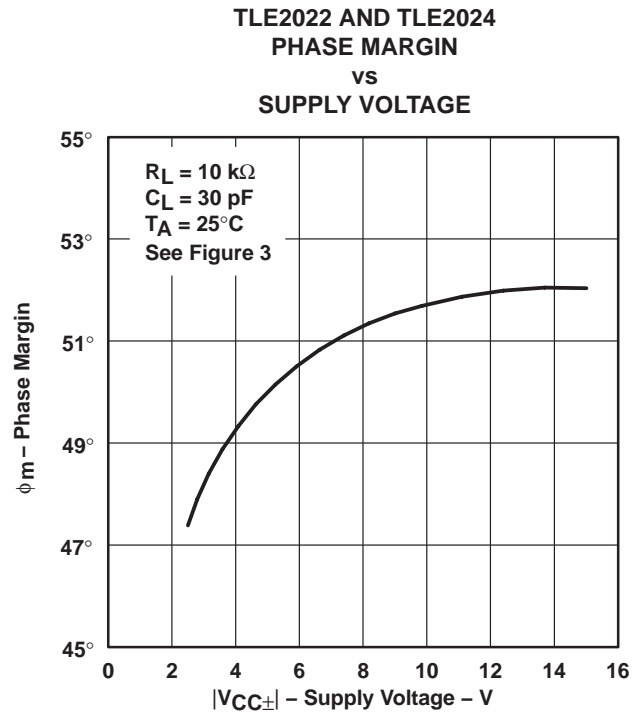

Figure 66

† Data at high and low temperatures are applicable only within the rated operating free-air temperature ranges of the various devices.

# TLE202x, TLE202xA, TLE202xB, TLE202xY EXCALIBUR HIGH-SPEED LOW-POWER PRECISION OPERATIONAL AMPLIFIERS

SLOS191C – FEBRUARY 1997 – REVISED APRIL 2007

## TYPICAL CHARACTERISTICS

TLE2021  
PHASE MARGIN  
VS  
LOAD CAPACITANCE

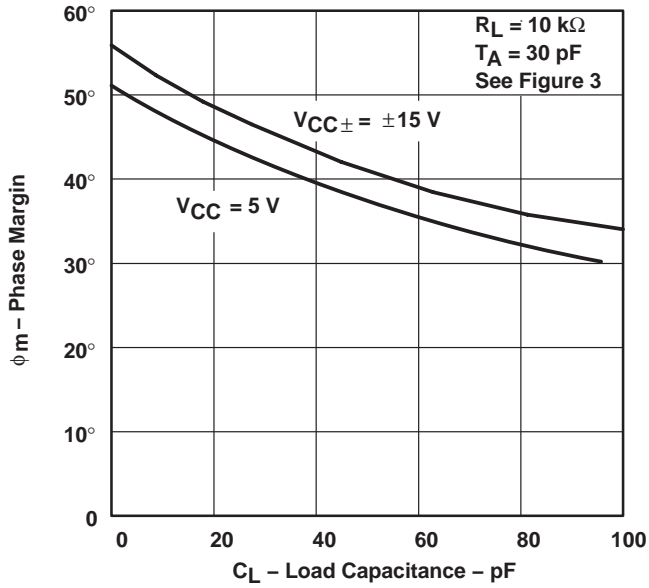

Figure 67

TLE2022 AND TLE2024  
PHASE MARGIN  
VS  
LOAD CAPACITANCE

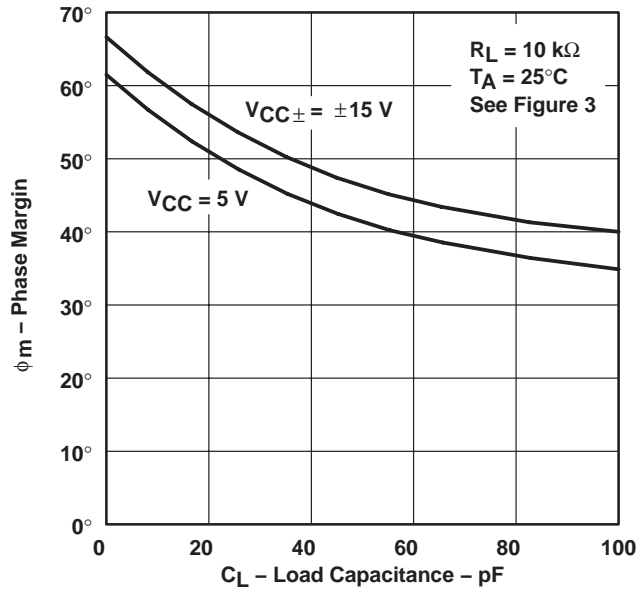

Figure 68

TLE2021  
PHASE MARGIN†  
VS  
FREE-AIR TEMPERATURE

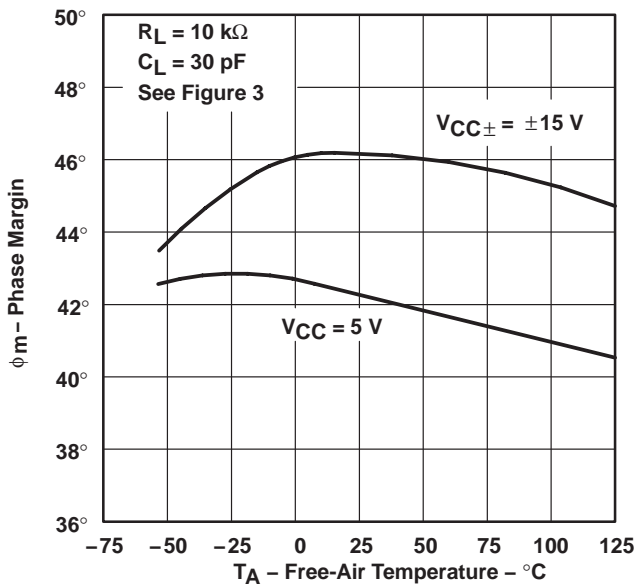

Figure 69

TLE2022 AND TLE2024  
PHASE MARGIN†  
VS  
FREE-AIR TEMPERATURE

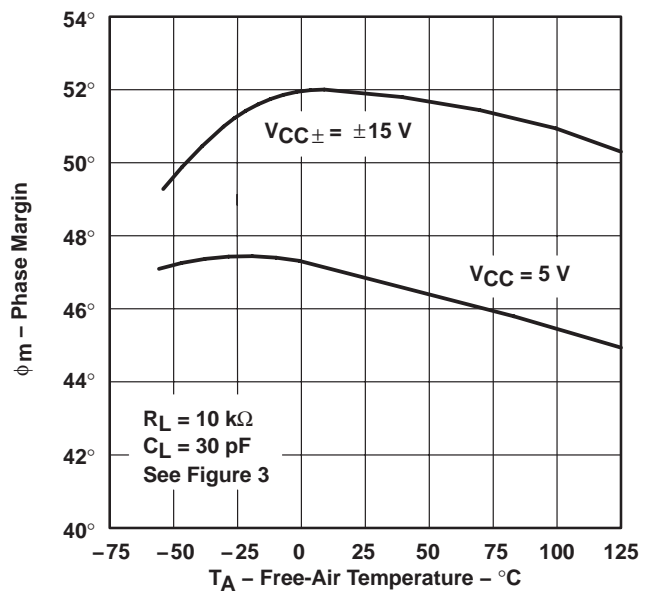

Figure 70

† Data at high and low temperatures are applicable only within the rated operating free-air temperature ranges of the various devices.

## APPLICATION INFORMATION

### voltage-follower applications

The TLE202x circuitry includes input-protection diodes to limit the voltage across the input transistors; however, no provision is made in the circuit to limit the current if these diodes are forward biased. This condition can occur when the device is operated in the voltage-follower configuration and driven with a fast, large-signal pulse. It is recommended that a feedback resistor be used to limit the current to a maximum of 1 mA to prevent degradation of the device. This feedback resistor forms a pole with the input capacitance of the device. For feedback resistor values greater than 10 k $\Omega$ , this pole degrades the amplifier phase margin. This problem can be alleviated by adding a capacitor (20 pF to 50 pF) in parallel with the feedback resistor (see Figure 71).

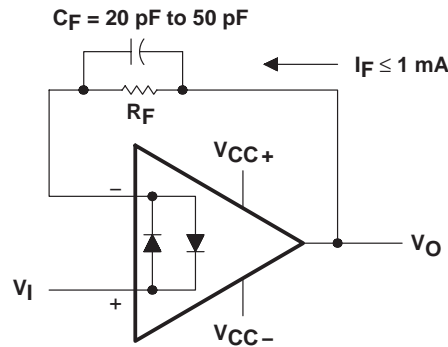

**Figure 71. Voltage Follower**

### Input offset voltage nulling

The TLE202x series offers external null pins that further reduce the input offset voltage. The circuit in Figure 72 can be connected as shown if this feature is desired. When external nulling is not needed, the null pins may be left disconnected.

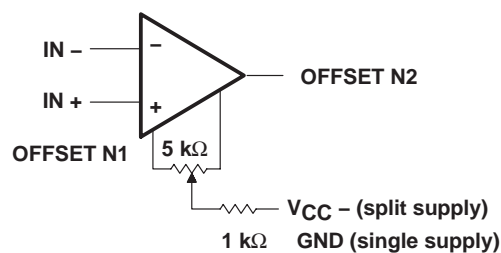

**Figure 72. Input Offset Voltage Null Circuit**

# TLE202x, TLE202xA, TLE202xB, TLE202xY EXCALIBUR HIGH-SPEED LOW-POWER PRECISION OPERATIONAL AMPLIFIERS

SLOS191C – FEBRUARY 1997 – REVISED APRIL 2007

## APPLICATION INFORMATION

### macromodel information

Macromodel information provided was derived using Microsim *Parts*<sup>™</sup>, the model generation software used with Microsim *PSpice*<sup>™</sup>. The Boyle macromodel (see Note 5) and subcircuit in Figure 73, Figure 74, and Figure 75 were generated using the TLE202x typical electrical and operating characteristics at 25°C. Using this information, output simulations of the following key parameters can be generated to a tolerance of 20% (in most cases):

- Maximum positive output voltage swing
- Maximum negative output voltage swing
- Slew rate
- Quiescent power dissipation
- Input bias current
- Open-loop voltage amplification
- Unity-gain frequency
- Common-mode rejection ratio
- Phase margin
- DC output resistance
- AC output resistance
- Short-circuit output current limit

NOTE 5: G. R. Boyle, B. M. Cohn, D. O. Pederson, and J. E. Solomon, "Macromodeling of Integrated Circuit Operational Amplifiers", *IEEE Journal of Solid-State Circuits*, SC-9, 353 (1974).

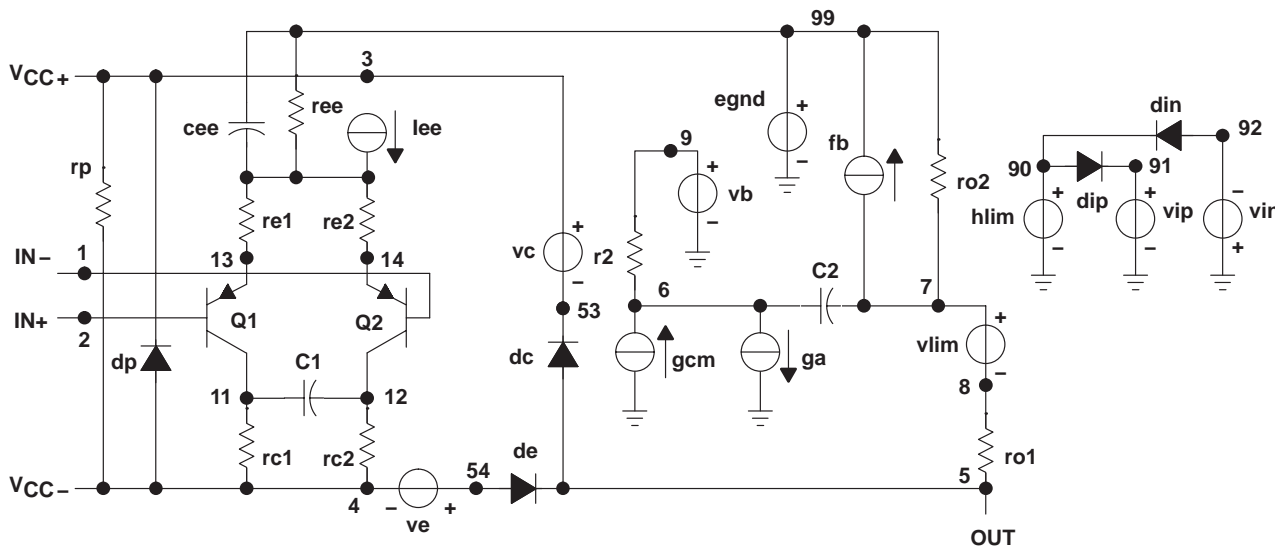

Figure 73. Boyle Subcircuit

*PSpice* and *Parts* are trademarks of MicroSim Corporation.



POST OFFICE BOX 655303 • DALLAS, TEXAS 75265

# TLE202x, TLE202xA, TLE202xB, TLE202xY EXCALIBUR HIGH-SPEED LOW-POWER PRECISION OPERATIONAL AMPLIFIERS

SLOS191C – FEBRUARY 1997 – REVISED APRIL 2007

```
.SUBCKT TLE2021 1 2 3 4 5
*
c1 11 12 6.244E-12
c2 6 7 13.4E-12
c3 87 0 10.64E-9
cpsr 85 86 15.9E-9
dcm+ 81 82 dx
dcm- 83 81 dx
dc 5 53 dx
de 54 5 dx
dlp 90 91 dx
dln 92 90 dx
dp 4 3 dx
ecmr 84 99 (2 99) 1
egnd 99 0 poly(2) (3,0) (4,0) 0 .5 .5
epsr 85 0 poly(1) (3,4) -60E-6 2.0E-6
ense 89 2 poly(1) (88,0) 120E-6 1
fb 7 99 poly(6) vb vc ve vlp vln vpsr 0 547.3E6
+ -50E7 50E7 50E7 -50E7 547E6
ga 6 0 11 12 188.5E-6
gcm 0 6 10 99 335.2E-12
gpsr 85 86 (85,86) 100E-6
grc1 4 11 (4,11) 1.885E-4
grc2 4 12 (4,12) 1.885E-4
gre1 13 10 (13,10) 6.82E-4
gre2 14 10 (14,10) 6.82E-4
hlim 90 0 vlim 1k

hcmr 80 1 poly(2) vcm+ vcm- 0 1E2 1E2
irp 3 4 185E-6
iee 3 10 dc 15.67E-6
iio 2 0 2E-9
i1 88 0 1E-21
q1 11 89 13 qx
q2 12 80 14 qx
R2 6 9 100.0E3
rcm 84 81 1K
ree 10 99 14.76E6
rn1 87 0 2.55E8
rn2 87 88 11.67E3
ro1 8 5 62
ro2 7 99 63
vcm+ 82 99 13.3
vcm- 83 99 -14.6
vb 9 0 dc 0
vc 3 53 dc 1.300
ve 54 4 dc 1.500
vlim 7 8 dc 0
vlp 91 0 dc 3.600
vln 0 92 dc 3.600
vpsr 0 86 dc 0
.model dx d(is=800.0E-18)
.model qx pnp(is=800.0E-18 bf=270)
.ends
```

**Figure 74. Boyle Macromodel for the TLE2021**

```
.SUBCKT TLE2022 1 2 3 4 5
*
c1 11 12 6.814E-12
c2 6 7 20.00E-12
dc 5 53 dx
de 54 5 dx
dlp 90 91 dx
dln 92 90 dx
dp 4 3 dx
egnd 99 0 poly(2) (3,0) (4,0) 0 .5 .5
fb 7 99 poly(5) vb vc ve vlp vln 0
+ 45.47E6 -50E6 50E6 50E6 -50E6
ga 6 0 11 12 377.9E-6
gcm 0 6 10 99 7.84E-10
iee 3 10 DC 18.07E-6
hlim 90 0 vlim 1k
q1 11 2 13 qx
q2 12 1 14 qx
r2 6 9 100.0E3

rc1 4 11 2.842E3
rc2 4 12 2.842E3
ge1 13 10 (10,13) 31.299E-3
ge2 14 10 (10,14) 31.299E-3
ree 10 99 11.07E6
ro1 8 5 250
ro2 7 99 250
rp 3 4 137.2E3
vb 9 0 dc 0
vc 3 53 dc 1.300
ve 54 4 dc 1.500
vlim 7 8 dc 0
vlp 91 0 dc 3
vln 0 92 dc 3
.model dx d(is=800.0E-18)
.model qx pnp(is=800.0E-18 bf=257.1)
.ends
```

**Figure 75. Boyle Macromodel for the TLE2022**



**PACKAGING INFORMATION**

Orderable Device	Status <sup>(1)</sup>	Package Type	Package Drawing	Pins	Package Qty	Eco Plan <sup>(2)</sup>	Lead/ Ball Finish	MSL Peak Temp <sup>(3)</sup>	Samples (Requires Login)
5962-9088101MPA	ACTIVE	CDIP	JG	8	1	TBD	A42	N / A for Pkg Type	Contact TI Distributor or Sales Office
5962-9088102M2A	ACTIVE	LCCC	FK	20	1	TBD	POST-PLATE	N / A for Pkg Type	<a href="#">Purchase Samples</a>
5962-9088102MPA	ACTIVE	CDIP	JG	8	1	TBD	A42	N / A for Pkg Type	Contact TI Distributor or Sales Office
5962-9088103M2A	ACTIVE	LCCC	FK	20	1	TBD	POST-PLATE	N / A for Pkg Type	<a href="#">Purchase Samples</a>
5962-9088103MCA	ACTIVE	CDIP	J	14	1	TBD	A42	N / A for Pkg Type	<a href="#">Purchase Samples</a>
5962-9088104Q2A	ACTIVE	LCCC	FK	20	1	TBD	POST-PLATE	N / A for Pkg Type	Contact TI Distributor or Sales Office
5962-9088104QPA	ACTIVE	CDIP	JG	8	1	TBD	A42	N / A for Pkg Type	Contact TI Distributor or Sales Office
5962-9088105Q2A	ACTIVE	LCCC	FK	20	1	TBD	POST-PLATE	N / A for Pkg Type	<a href="#">Purchase Samples</a>
5962-9088105QPA	ACTIVE	CDIP	JG	8	1	TBD	A42	N / A for Pkg Type	<a href="#">Purchase Samples</a>
5962-9088106Q2A	ACTIVE	LCCC	FK	20	1	TBD	POST-PLATE	N / A for Pkg Type	<a href="#">Purchase Samples</a>
5962-9088106QCA	ACTIVE	CDIP	J	14	1	TBD	A42	N / A for Pkg Type	<a href="#">Purchase Samples</a>
5962-9088107Q2A	ACTIVE	LCCC	FK	20	1	TBD	POST-PLATE	N / A for Pkg Type	<a href="#">Purchase Samples</a>
5962-9088107QPA	ACTIVE	CDIP	JG	8	1	TBD	A42	N / A for Pkg Type	<a href="#">Purchase Samples</a>
5962-9088108Q2A	ACTIVE	LCCC	FK	20	1	TBD	POST-PLATE	N / A for Pkg Type	<a href="#">Purchase Samples</a>
5962-9088108QPA	ACTIVE	CDIP	JG	8	1	TBD	A42	N / A for Pkg Type	<a href="#">Purchase Samples</a>
5962-9088109Q2A	ACTIVE	LCCC	FK	20	1	TBD	POST-PLATE	N / A for Pkg Type	<a href="#">Purchase Samples</a>
5962-9088109QCA	ACTIVE	CDIP	J	14	1	TBD	A42	N / A for Pkg Type	<a href="#">Purchase Samples</a>
TLE2021ACD	ACTIVE	SOIC	D	8	75	Green (RoHS & no Sb/Br)	CU NIPDAU	Level-1-260C-UNLIM	<a href="#">Request Free Samples</a>
TLE2021ACDG4	ACTIVE	SOIC	D	8	75	Green (RoHS & no Sb/Br)	CU NIPDAU	Level-1-260C-UNLIM	<a href="#">Request Free Samples</a>
TLE2021ACDR	ACTIVE	SOIC	D	8	2500	Green (RoHS & no Sb/Br)	CU NIPDAU	Level-1-260C-UNLIM	<a href="#">Purchase Samples</a>
TLE2021ACDRG4	ACTIVE	SOIC	D	8	2500	Green (RoHS & no Sb/Br)	CU NIPDAU	Level-1-260C-UNLIM	<a href="#">Purchase Samples</a>
TLE2021ACP	ACTIVE	PDIP	P	8	50	Pb-Free (RoHS)	CU NIPDAU	N / A for Pkg Type	<a href="#">Request Free Samples</a>
TLE2021ACPE4	ACTIVE	PDIP	P	8	50	Pb-Free (RoHS)	CU NIPDAU	N / A for Pkg Type	<a href="#">Request Free Samples</a>
TLE2021ACPS	OBSOLETE	SO	PS	8		TBD	Call TI	Call TI	Samples Not Available



Orderable Device	Status <sup>(1)</sup>	Package Type	Package Drawing	Pins	Package Qty	Eco Plan <sup>(2)</sup>	Lead/ Ball Finish	MSL Peak Temp <sup>(3)</sup>	Samples (Requires Login)
TLE2021ACPSG4	OBSOLETE	SO	PS	8		TBD	Call TI	Call TI	Samples Not Available
TLE2021AID	ACTIVE	SOIC	D	8	75	Green (RoHS & no Sb/Br)	CU NIPDAU	Level-1-260C-UNLIM	<a href="#">Request Free Samples</a>
TLE2021AIDG4	ACTIVE	SOIC	D	8	75	Green (RoHS & no Sb/Br)	CU NIPDAU	Level-1-260C-UNLIM	<a href="#">Request Free Samples</a>
TLE2021AIP	ACTIVE	PDIP	P	8	50	Pb-Free (RoHS)	CU NIPDAU	N / A for Pkg Type	<a href="#">Request Free Samples</a>
TLE2021AIPE4	ACTIVE	PDIP	P	8	50	Pb-Free (RoHS)	CU NIPDAU	N / A for Pkg Type	<a href="#">Request Free Samples</a>
TLE2021AMFKB	ACTIVE	LCCC	FK	20	1	TBD	POST-PLATE	N / A for Pkg Type	Contact TI Distributor or Sales Office
TLE2021AMJGB	ACTIVE	CDIP	JG	8	1	TBD	A42	N / A for Pkg Type	Contact TI Distributor or Sales Office
TLE2021BMFKB	ACTIVE	LCCC	FK	20	1	TBD	POST-PLATE	N / A for Pkg Type	Contact TI Distributor or Sales Office
TLE2021BMJG	ACTIVE	CDIP	JG	8	1	TBD	A42	N / A for Pkg Type	Contact TI Distributor or Sales Office
TLE2021BMJGB	ACTIVE	CDIP	JG	8	1	TBD	A42	N / A for Pkg Type	Contact TI Distributor or Sales Office
TLE2021CD	ACTIVE	SOIC	D	8	75	Green (RoHS & no Sb/Br)	CU NIPDAU	Level-1-260C-UNLIM	<a href="#">Request Free Samples</a>
TLE2021CDG4	ACTIVE	SOIC	D	8	75	Green (RoHS & no Sb/Br)	CU NIPDAU	Level-1-260C-UNLIM	<a href="#">Request Free Samples</a>
TLE2021CDR	ACTIVE	SOIC	D	8	2500	Green (RoHS & no Sb/Br)	CU NIPDAU	Level-1-260C-UNLIM	<a href="#">Purchase Samples</a>
TLE2021CDRG4	ACTIVE	SOIC	D	8	2500	Green (RoHS & no Sb/Br)	CU NIPDAU	Level-1-260C-UNLIM	<a href="#">Purchase Samples</a>
TLE2021CP	ACTIVE	PDIP	P	8	50	Pb-Free (RoHS)	CU NIPDAU	N / A for Pkg Type	<a href="#">Request Free Samples</a>
TLE2021CPE4	ACTIVE	PDIP	P	8	50	Pb-Free (RoHS)	CU NIPDAU	N / A for Pkg Type	<a href="#">Request Free Samples</a>
TLE2021CPWLE	OBSOLETE	TSSOP	PW	8		TBD	Call TI	Call TI	Samples Not Available
TLE2021CPWR	ACTIVE	TSSOP	PW	8	2000	Green (RoHS & no Sb/Br)	CU NIPDAU	Level-1-260C-UNLIM	<a href="#">Purchase Samples</a>
TLE2021CPWRG4	ACTIVE	TSSOP	PW	8	2000	Green (RoHS & no Sb/Br)	CU NIPDAU	Level-1-260C-UNLIM	<a href="#">Purchase Samples</a>
TLE2021ID	ACTIVE	SOIC	D	8	75	Green (RoHS & no Sb/Br)	CU NIPDAU	Level-1-260C-UNLIM	<a href="#">Request Free Samples</a>

Orderable Device	Status <sup>(1)</sup>	Package Type	Package Drawing	Pins	Package Qty	Eco Plan <sup>(2)</sup>	Lead/ Ball Finish	MSL Peak Temp <sup>(3)</sup>	Samples (Requires Login)
TLE2021IDG4	ACTIVE	SOIC	D	8	75	Green (RoHS & no Sb/Br)	CU NIPDAU	Level-1-260C-UNLIM	<a href="#">Request Free Samples</a>
TLE2021IDR	ACTIVE	SOIC	D	8	2500	Green (RoHS & no Sb/Br)	CU NIPDAU	Level-1-260C-UNLIM	<a href="#">Purchase Samples</a>
TLE2021IDRG4	ACTIVE	SOIC	D	8	2500	Green (RoHS & no Sb/Br)	CU NIPDAU	Level-1-260C-UNLIM	<a href="#">Purchase Samples</a>
TLE2021IP	ACTIVE	PDIP	P	8	50	Pb-Free (RoHS)	CU NIPDAU	N / A for Pkg Type	<a href="#">Request Free Samples</a>
TLE2021IPE4	ACTIVE	PDIP	P	8	50	Pb-Free (RoHS)	CU NIPDAU	N / A for Pkg Type	<a href="#">Request Free Samples</a>
TLE2021MD	ACTIVE	SOIC	D	8	75	TBD	CU NIPDAU	Level-1-220C-UNLIM	<a href="#">Request Free Samples</a>
TLE2021MDG4	ACTIVE	SOIC	D	8	75	Green (RoHS & no Sb/Br)	CU NIPDAU	Level-1-260C-UNLIM	<a href="#">Purchase Samples</a>
TLE2021MFKB	OBSOLETE	LCCC	FK	20		TBD	Call TI	Call TI	Samples Not Available
TLE2021MJG	ACTIVE	CDIP	JG	8	1	TBD	A42	N / A for Pkg Type	Contact TI Distributor or Sales Office
TLE2021MJGB	ACTIVE	CDIP	JG	8	1	TBD	A42	N / A for Pkg Type	Contact TI Distributor or Sales Office
TLE2022ACD	ACTIVE	SOIC	D	8	75	Green (RoHS & no Sb/Br)	CU NIPDAU	Level-1-260C-UNLIM	<a href="#">Request Free Samples</a>
TLE2022ACDG4	ACTIVE	SOIC	D	8	75	Green (RoHS & no Sb/Br)	CU NIPDAU	Level-1-260C-UNLIM	<a href="#">Request Free Samples</a>
TLE2022ACDR	ACTIVE	SOIC	D	8	2500	Green (RoHS & no Sb/Br)	CU NIPDAU	Level-1-260C-UNLIM	<a href="#">Purchase Samples</a>
TLE2022ACDRG4	ACTIVE	SOIC	D	8	2500	Green (RoHS & no Sb/Br)	CU NIPDAU	Level-1-260C-UNLIM	<a href="#">Purchase Samples</a>
TLE2022ACP	ACTIVE	PDIP	P	8	50	Pb-Free (RoHS)	CU NIPDAU	N / A for Pkg Type	<a href="#">Request Free Samples</a>
TLE2022ACPE4	ACTIVE	PDIP	P	8	50	Pb-Free (RoHS)	CU NIPDAU	N / A for Pkg Type	<a href="#">Request Free Samples</a>
TLE2022AID	ACTIVE	SOIC	D	8	75	Green (RoHS & no Sb/Br)	CU NIPDAU	Level-1-260C-UNLIM	<a href="#">Request Free Samples</a>
TLE2022AIDG4	ACTIVE	SOIC	D	8	75	Green (RoHS & no Sb/Br)	CU NIPDAU	Level-1-260C-UNLIM	<a href="#">Request Free Samples</a>
TLE2022AIDR	ACTIVE	SOIC	D	8	2500	Green (RoHS & no Sb/Br)	CU NIPDAU	Level-1-260C-UNLIM	<a href="#">Purchase Samples</a>
TLE2022AIDRG4	ACTIVE	SOIC	D	8	2500	Green (RoHS & no Sb/Br)	CU NIPDAU	Level-1-260C-UNLIM	<a href="#">Purchase Samples</a>
TLE2022AIP	ACTIVE	PDIP	P	8	50	Pb-Free (RoHS)	CU NIPDAU	N / A for Pkg Type	<a href="#">Request Free Samples</a>

Orderable Device	Status <sup>(1)</sup>	Package Type	Package Drawing	Pins	Package Qty	Eco Plan <sup>(2)</sup>	Lead/ Ball Finish	MSL Peak Temp <sup>(3)</sup>	Samples (Requires Login)
TLE2022AIPE4	ACTIVE	PDIP	P	8	50	Pb-Free (RoHS)	CU NIPDAU	N / A for Pkg Type	<a href="#">Request Free Samples</a>
TLE2022AMD	ACTIVE	SOIC	D	8	75	TBD	CU NIPDAU	Level-1-220C-UNLIM	<a href="#">Request Free Samples</a>
TLE2022AMDG4	ACTIVE	SOIC	D	8	75	Green (RoHS & no Sb/Br)	CU NIPDAU	Level-1-260C-UNLIM	<a href="#">Purchase Samples</a>
TLE2022AMDR	ACTIVE	SOIC	D	8	2500	Green (RoHS & no Sb/Br)	CU NIPDAU	Level-1-260C-UNLIM	<a href="#">Purchase Samples</a>
TLE2022AMDRG4	ACTIVE	SOIC	D	8	2500	Green (RoHS & no Sb/Br)	CU NIPDAU	Level-1-260C-UNLIM	<a href="#">Purchase Samples</a>
TLE2022AMFKB	ACTIVE	LCCC	FK	20	1	TBD	POST-PLATE	N / A for Pkg Type	Contact TI Distributor or Sales Office
TLE2022AMJG	OBSOLETE	CDIP	JG	8		TBD	Call TI	Call TI	Replaced by TLE2022AMJGB
TLE2022AMJGB	ACTIVE	CDIP	JG	8	1	TBD	A42	N / A for Pkg Type	Contact TI Distributor or Sales Office
TLE2022BCDR	OBSOLETE	SOIC	D	8		TBD	Call TI	Call TI	Samples Not Available
TLE2022BMFKB	ACTIVE	LCCC	FK	20	1	TBD	POST-PLATE	N / A for Pkg Type	Contact TI Distributor or Sales Office
TLE2022BMJG	OBSOLETE	CDIP	JG	8		TBD	Call TI	Call TI	Samples Not Available
TLE2022BMJGB	ACTIVE	CDIP	JG	8	1	TBD	A42	N / A for Pkg Type	Contact TI Distributor or Sales Office
TLE2022CD	ACTIVE	SOIC	D	8	75	Green (RoHS & no Sb/Br)	CU NIPDAU	Level-1-260C-UNLIM	<a href="#">Request Free Samples</a>
TLE2022CDG4	ACTIVE	SOIC	D	8	75	Green (RoHS & no Sb/Br)	CU NIPDAU	Level-1-260C-UNLIM	<a href="#">Request Free Samples</a>
TLE2022CDR	ACTIVE	SOIC	D	8	2500	Green (RoHS & no Sb/Br)	CU NIPDAU	Level-1-260C-UNLIM	<a href="#">Purchase Samples</a>
TLE2022CDRG4	ACTIVE	SOIC	D	8	2500	Green (RoHS & no Sb/Br)	CU NIPDAU	Level-1-260C-UNLIM	<a href="#">Purchase Samples</a>
TLE2022CP	ACTIVE	PDIP	P	8	50	Pb-Free (RoHS)	CU NIPDAU	N / A for Pkg Type	<a href="#">Request Free Samples</a>
TLE2022CPE4	ACTIVE	PDIP	P	8	50	Pb-Free (RoHS)	CU NIPDAU	N / A for Pkg Type	<a href="#">Request Free Samples</a>
TLE2022CPSR	OBSOLETE	SO	PS	8		TBD	Call TI	Call TI	Samples Not Available
TLE2022ID	ACTIVE	SOIC	D	8	75	Green (RoHS & no Sb/Br)	CU NIPDAU	Level-1-260C-UNLIM	<a href="#">Request Free Samples</a>
TLE2022IDG4	ACTIVE	SOIC	D	8	75	Green (RoHS & no Sb/Br)	CU NIPDAU	Level-1-260C-UNLIM	<a href="#">Request Free Samples</a>

Orderable Device	Status <sup>(1)</sup>	Package Type	Package Drawing	Pins	Package Qty	Eco Plan <sup>(2)</sup>	Lead/ Ball Finish	MSL Peak Temp <sup>(3)</sup>	Samples (Requires Login)
TLE2022IDR	ACTIVE	SOIC	D	8	2500	Green (RoHS & no Sb/Br)	CU NIPDAU	Level-1-260C-UNLIM	<a href="#">Purchase Samples</a>
TLE2022IDRG4	ACTIVE	SOIC	D	8	2500	Green (RoHS & no Sb/Br)	CU NIPDAU	Level-1-260C-UNLIM	<a href="#">Purchase Samples</a>
TLE2022IP	ACTIVE	PDIP	P	8	50	Pb-Free (RoHS)	CU NIPDAU	N / A for Pkg Type	<a href="#">Request Free Samples</a>
TLE2022IPE4	ACTIVE	PDIP	P	8	50	Pb-Free (RoHS)	CU NIPDAU	N / A for Pkg Type	<a href="#">Request Free Samples</a>
TLE2022MD	ACTIVE	SOIC	D	8	75	TBD	CU NIPDAU	Level-1-220C-UNLIM	<a href="#">Request Free Samples</a>
TLE2022MDG4	ACTIVE	SOIC	D	8	75	Green (RoHS & no Sb/Br)	CU NIPDAU	Level-1-260C-UNLIM	<a href="#">Purchase Samples</a>
TLE2022MDR	ACTIVE	SOIC	D	8	2500	TBD	CU NIPDAU	Level-1-220C-UNLIM	Contact TI Distributor or Sales Office
TLE2022MDRG4	ACTIVE	SOIC	D	8	2500	Green (RoHS & no Sb/Br)	CU NIPDAU	Level-1-260C-UNLIM	<a href="#">Purchase Samples</a>
TLE2022MFKB	ACTIVE	LCCC	FK	20	1	TBD	POST-PLATE	N / A for Pkg Type	Contact TI Distributor or Sales Office
TLE2022MJG	ACTIVE	CDIP	JG	8	1	TBD	A42	N / A for Pkg Type	Contact TI Distributor or Sales Office
TLE2022MJGB	ACTIVE	CDIP	JG	8	1	TBD	A42	N / A for Pkg Type	Contact TI Distributor or Sales Office
TLE2024ACDW	ACTIVE	SOIC	DW	16	40	Green (RoHS & no Sb/Br)	CU NIPDAU	Level-1-260C-UNLIM	<a href="#">Request Free Samples</a>
TLE2024ACDWG4	ACTIVE	SOIC	DW	16	40	Green (RoHS & no Sb/Br)	CU NIPDAU	Level-1-260C-UNLIM	<a href="#">Request Free Samples</a>
TLE2024ACDWR	ACTIVE	SOIC	DW	16	2000	Green (RoHS & no Sb/Br)	CU NIPDAU	Level-1-260C-UNLIM	<a href="#">Purchase Samples</a>
TLE2024ACDWRG4	ACTIVE	SOIC	DW	16	2000	Green (RoHS & no Sb/Br)	CU NIPDAU	Level-1-260C-UNLIM	<a href="#">Purchase Samples</a>
TLE2024ACN	ACTIVE	PDIP	N	14	25	Pb-Free (RoHS)	CU NIPDAU	N / A for Pkg Type	<a href="#">Request Free Samples</a>
TLE2024ACNE4	ACTIVE	PDIP	N	14	25	Pb-Free (RoHS)	CU NIPDAU	N / A for Pkg Type	<a href="#">Request Free Samples</a>
TLE2024AIDW	ACTIVE	SOIC	DW	16	40	Green (RoHS & no Sb/Br)	CU NIPDAU	Level-1-260C-UNLIM	<a href="#">Request Free Samples</a>
TLE2024AIDWG4	ACTIVE	SOIC	DW	16	40	Green (RoHS & no Sb/Br)	CU NIPDAU	Level-1-260C-UNLIM	<a href="#">Request Free Samples</a>
TLE2024AIN	ACTIVE	PDIP	N	14	25	Pb-Free (RoHS)	CU NIPDAU	N / A for Pkg Type	<a href="#">Request Free Samples</a>
TLE2024AINE4	ACTIVE	PDIP	N	14	25	Pb-Free (RoHS)	CU NIPDAU	N / A for Pkg Type	<a href="#">Request Free Samples</a>

Orderable Device	Status <sup>(1)</sup>	Package Type	Package Drawing	Pins	Package Qty	Eco Plan <sup>(2)</sup>	Lead/ Ball Finish	MSL Peak Temp <sup>(3)</sup>	Samples (Requires Login)
TLE2024AMFKB	ACTIVE	LCCC	FK	20	1	TBD	POST-PLATE	N / A for Pkg Type	Contact TI Distributor or Sales Office
TLE2024AMJ	ACTIVE	CDIP	J	14	1	TBD	A42	N / A for Pkg Type	Contact TI Distributor or Sales Office
TLE2024AMJB	ACTIVE	CDIP	J	14	1	TBD	A42	N / A for Pkg Type	Contact TI Distributor or Sales Office
TLE2024BCDW	OBSOLETE	SOIC	DW	16		TBD	Call TI	Call TI	Samples Not Available
TLE2024BCN	OBSOLETE	PDIP	N	14		TBD	Call TI	Call TI	Samples Not Available
TLE2024BIDW	OBSOLETE	SOIC	DW	16		TBD	Call TI	Call TI	Samples Not Available
TLE2024BIN	OBSOLETE	PDIP	N	14		TBD	Call TI	Call TI	Samples Not Available
TLE2024BMDW	ACTIVE	SOIC	DW	16	40	TBD	CU NIPDAU	Level-1-220C-UNLIM	<a href="#">Request Free Samples</a>
TLE2024BMDWG4	ACTIVE	SOIC	DW	16	40	Green (RoHS & no Sb/Br)	CU NIPDAU	Level-1-260C-UNLIM	<a href="#">Purchase Samples</a>
TLE2024BMFKB	ACTIVE	LCCC	FK	20	1	TBD	POST-PLATE	N / A for Pkg Type	Contact TI Distributor or Sales Office
TLE2024BMJ	NRND	CDIP	J	14	1	TBD	A42	N / A for Pkg Type	Samples Not Available
TLE2024BMJB	ACTIVE	CDIP	J	14	1	TBD	A42	N / A for Pkg Type	Contact TI Distributor or Sales Office
TLE2024BMN	OBSOLETE	PDIP	N	14		TBD	Call TI	Call TI	Samples Not Available
TLE2024CDW	ACTIVE	SOIC	DW	16	40	Green (RoHS & no Sb/Br)	CU NIPDAU	Level-1-260C-UNLIM	<a href="#">Request Free Samples</a>
TLE2024CDWG4	ACTIVE	SOIC	DW	16	40	Green (RoHS & no Sb/Br)	CU NIPDAU	Level-1-260C-UNLIM	<a href="#">Request Free Samples</a>
TLE2024CDWR	ACTIVE	SOIC	DW	16	2000	Green (RoHS & no Sb/Br)	CU NIPDAU	Level-1-260C-UNLIM	<a href="#">Purchase Samples</a>
TLE2024CDWRG4	ACTIVE	SOIC	DW	16	2000	Green (RoHS & no Sb/Br)	CU NIPDAU	Level-1-260C-UNLIM	<a href="#">Purchase Samples</a>
TLE2024CN	ACTIVE	PDIP	N	14	25	Pb-Free (RoHS)	CU NIPDAU	N / A for Pkg Type	<a href="#">Request Free Samples</a>
TLE2024CNE4	ACTIVE	PDIP	N	14	25	Pb-Free (RoHS)	CU NIPDAU	N / A for Pkg Type	<a href="#">Request Free Samples</a>
TLE2024IDW	ACTIVE	SOIC	DW	16	40	Green (RoHS & no Sb/Br)	CU NIPDAU	Level-1-260C-UNLIM	<a href="#">Request Free Samples</a>
TLE2024IDWG4	ACTIVE	SOIC	DW	16	40	Green (RoHS & no Sb/Br)	CU NIPDAU	Level-1-260C-UNLIM	<a href="#">Request Free Samples</a>
TLE2024IN	ACTIVE	PDIP	N	14	25	Pb-Free (RoHS)	CU NIPDAU	N / A for Pkg Type	<a href="#">Request Free Samples</a>

Orderable Device	Status <sup>(1)</sup>	Package Type	Package Drawing	Pins	Package Qty	Eco Plan <sup>(2)</sup>	Lead/ Ball Finish	MSL Peak Temp <sup>(3)</sup>	Samples (Requires Login)
TLE2024INE4	ACTIVE	PDIP	N	14	25	Pb-Free (RoHS)	CU NIPDAU	N / A for Pkg Type	<a href="#">Request Free Samples</a>
TLE2024MDW	ACTIVE	SOIC	DW	16	40	TBD	CU NIPDAU	Level-1-220C-UNLIM	<a href="#">Request Free Samples</a>
TLE2024MDWG4	ACTIVE	SOIC	DW	16	100	Green (RoHS & no Sb/Br)	CU NIPDAU	Level-1-260C-UNLIM	<a href="#">Purchase Samples</a>
TLE2024MFKB	ACTIVE	LCCC	FK	20	1	TBD	POST-PLATE	N / A for Pkg Type	Contact TI Distributor or Sales Office
TLE2024MJ	OBSOLETE	CDIP	J	14		TBD	Call TI	Call TI	Samples Not Available
TLE2024MJB	ACTIVE	CDIP	J	14	1	TBD	A42	N / A for Pkg Type	Contact TI Distributor or Sales Office
TLE2024MN	OBSOLETE	PDIP	N	14		TBD	Call TI	Call TI	Samples Not Available

<sup>(1)</sup> The marketing status values are defined as follows:

**ACTIVE:** Product device recommended for new designs.

**LIFEBUY:** TI has announced that the device will be discontinued, and a lifetime-buy period is in effect.

**NRND:** Not recommended for new designs. Device is in production to support existing customers, but TI does not recommend using this part in a new design.

**PREVIEW:** Device has been announced but is not in production. Samples may or may not be available.

**OBSOLETE:** TI has discontinued the production of the device.

<sup>(2)</sup> Eco Plan - The planned eco-friendly classification: Pb-Free (RoHS), Pb-Free (RoHS Exempt), or Green (RoHS & no Sb/Br) - please check <http://www.ti.com/productcontent> for the latest availability information and additional product content details.

**TBD:** The Pb-Free/Green conversion plan has not been defined.

**Pb-Free (RoHS):** TI's terms "Lead-Free" or "Pb-Free" mean semiconductor products that are compatible with the current RoHS requirements for all 6 substances, including the requirement that lead not exceed 0.1% by weight in homogeneous materials. Where designed to be soldered at high temperatures, TI Pb-Free products are suitable for use in specified lead-free processes.

**Pb-Free (RoHS Exempt):** This component has a RoHS exemption for either 1) lead-based flip-chip solder bumps used between the die and package, or 2) lead-based die adhesive used between the die and leadframe. The component is otherwise considered Pb-Free (RoHS compatible) as defined above.

**Green (RoHS & no Sb/Br):** TI defines "Green" to mean Pb-Free (RoHS compatible), and free of Bromine (Br) and Antimony (Sb) based flame retardants (Br or Sb do not exceed 0.1% by weight in homogeneous material)

<sup>(3)</sup> MSL, Peak Temp. -- The Moisture Sensitivity Level rating according to the JEDEC industry standard classifications, and peak solder temperature.

**Important Information and Disclaimer:** The information provided on this page represents TI's knowledge and belief as of the date that it is provided. TI bases its knowledge and belief on information provided by third parties, and makes no representation or warranty as to the accuracy of such information. Efforts are underway to better integrate information from third parties. TI has taken and continues to take reasonable steps to provide representative and accurate information but may not have conducted destructive testing or chemical analysis on incoming materials and chemicals. TI and TI suppliers consider certain information to be proprietary, and thus CAS numbers and other limited information may not be available for release.

In no event shall TI's liability arising out of such information exceed the total purchase price of the TI part(s) at issue in this document sold by TI to Customer on an annual basis.

---

**OTHER QUALIFIED VERSIONS OF TLE2021, TLE2021A, TLE2021AM, TLE2021M, TLE2022, TLE2022A, TLE2022AM, TLE2022B, TLE2022BM, TLE2022M, TLE2024, TLE2024A, TLE2024AM, TLE2024B, TLE2024BM, TLE2024M :**

- Catalog: [TLE2021A](#), [TLE2021](#), [TLE2022A](#), [TLE2022B](#), [TLE2022](#), [TLE2024A](#), [TLE2024B](#), [TLE2024](#)
- Automotive: [TLE2021-Q1](#), [TLE2021A-Q1](#), [TLE2021A-Q1](#), [TLE2021-Q1](#), [TLE2022-Q1](#), [TLE2022A-Q1](#), [TLE2022A-Q1](#), [TLE2022-Q1](#), [TLE2024-Q1](#), [TLE2024A-Q1](#), [TLE2024A-Q1](#), [TLE2024-Q1](#)
- Enhanced Product: [TLE2021-EP](#), [TLE2021A-EP](#), [TLE2021A-EP](#), [TLE2021-EP](#), [TLE2022-EP](#), [TLE2022A-EP](#), [TLE2022A-EP](#), [TLE2022-EP](#), [TLE2024-EP](#), [TLE2024A-EP](#), [TLE2024A-EP](#), [TLE2024-EP](#)
- Military: [TLE2021M](#), [TLE2021AM](#), [TLE2022M](#), [TLE2022AM](#), [TLE2022BM](#), [TLE2024M](#), [TLE2024AM](#), [TLE2024BM](#)

NOTE: Qualified Version Definitions:

- Catalog - TI's standard catalog product
- Automotive - Q100 devices qualified for high-reliability automotive applications targeting zero defects
- Enhanced Product - Supports Defense, Aerospace and Medical Applications
- Military - QML certified for Military and Defense Applications

## TAPE AND REEL INFORMATION

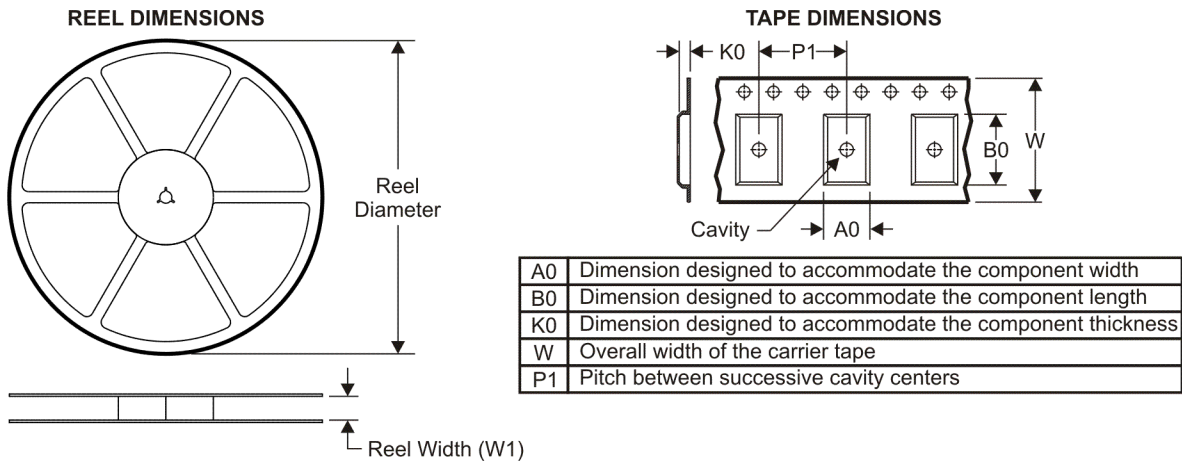

### QUADRANT ASSIGNMENTS FOR PIN 1 ORIENTATION IN TAPE



\*All dimensions are nominal

Device	Package Type	Package Drawing	Pins	SPQ	Reel Diameter (mm)	Reel Width W1 (mm)	A0 (mm)	B0 (mm)	K0 (mm)	P1 (mm)	W (mm)	Pin1 Quadrant
TLE2021ACDR	SOIC	D	8	2500	330.0	12.4	6.4	5.2	2.1	8.0	12.0	Q1
TLE2021ACDR	SOIC	D	8	2500	330.0	12.4	6.4	5.2	2.1	8.0	12.0	Q1
TLE2021CDR	SOIC	D	8	2500	330.0	12.4	6.4	5.2	2.1	8.0	12.0	Q1
TLE2021CDR	SOIC	D	8	2500	330.0	12.4	6.4	5.2	2.1	8.0	12.0	Q1
TLE2021CPWR	TSSOP	PW	8	2000	330.0	12.4	7.0	3.6	1.6	8.0	12.0	Q1
TLE2021IDR	SOIC	D	8	2500	330.0	12.4	6.4	5.2	2.1	8.0	12.0	Q1
TLE2022ACDR	SOIC	D	8	2500	330.0	12.4	6.4	5.2	2.1	8.0	12.0	Q1
TLE2022AIDR	SOIC	D	8	2500	330.0	12.4	6.4	5.2	2.1	8.0	12.0	Q1
TLE2022CDR	SOIC	D	8	2500	330.0	12.4	6.4	5.2	2.1	8.0	12.0	Q1
TLE2022IDR	SOIC	D	8	2500	330.0	12.4	6.4	5.2	2.1	8.0	12.0	Q1
TLE2024ACDWR	SOIC	DW	16	2000	330.0	16.4	10.75	10.7	2.7	12.0	16.0	Q1
TLE2024CDWR	SOIC	DW	16	2000	330.0	16.4	10.75	10.7	2.7	12.0	16.0	Q1



**TAPE AND REEL BOX DIMENSIONS**

\*All dimensions are nominal

Device	Package Type	Package Drawing	Pins	SPQ	Length (mm)	Width (mm)	Height (mm)
TLE2021ACDR	SOIC	D	8	2500	346.0	346.0	29.0
TLE2021ACDR	SOIC	D	8	2500	340.5	338.1	20.6
TLE2021CDR	SOIC	D	8	2500	346.0	346.0	29.0
TLE2021CDR	SOIC	D	8	2500	340.5	338.1	20.6
TLE2021CPWR	TSSOP	PW	8	2000	346.0	346.0	29.0
TLE2021IDR	SOIC	D	8	2500	346.0	346.0	29.0
TLE2022ACDR	SOIC	D	8	2500	340.5	338.1	20.6
TLE2022AIDR	SOIC	D	8	2500	340.5	338.1	20.6
TLE2022CDR	SOIC	D	8	2500	340.5	338.1	20.6
TLE2022IDR	SOIC	D	8	2500	340.5	338.1	20.6
TLE2024ACDWR	SOIC	DW	16	2000	346.0	346.0	33.0
TLE2024CDWR	SOIC	DW	16	2000	346.0	346.0	33.0

JG (R-GDIP-T8)

CERAMIC DUAL-IN-LINE



- NOTES: A. All linear dimensions are in inches (millimeters).  
 B. This drawing is subject to change without notice.  
 C. This package can be hermetically sealed with a ceramic lid using glass frit.  
 D. Index point is provided on cap for terminal identification.  
 E. Falls within MIL STD 1835 GDIP1-T8

J (R-GDIP-T\*\*)

14 LEADS SHOWN

CERAMIC DUAL IN-LINE PACKAGE



DIM \ PINS **	14	16	18	20
A	0.300 (7,62) BSC	0.300 (7,62) BSC	0.300 (7,62) BSC	0.300 (7,62) BSC
B MAX	0.785 (19,94)	.840 (21,34)	0.960 (24,38)	1.060 (26,92)
B MIN	—	—	—	—
C MAX	0.300 (7,62)	0.300 (7,62)	0.310 (7,87)	0.300 (7,62)
C MIN	0.245 (6,22)	0.245 (6,22)	0.220 (5,59)	0.245 (6,22)



4040083/F 03/03

- NOTES:
- All linear dimensions are in inches (millimeters).
  - This drawing is subject to change without notice.
  - This package is hermetically sealed with a ceramic lid using glass frit.
  - Index point is provided on cap for terminal identification only on press ceramic glass frit seal only.
  - Falls within MIL STD 1835 GDIP1-T14, GDIP1-T16, GDIP1-T18 and GDIP1-T20.

FK (S-CQCC-N\*\*)

LEADLESS CERAMIC CHIP CARRIER

28 TERMINAL SHOWN



4040140/D 10/96

- NOTES:
- A. All linear dimensions are in inches (millimeters).
  - B. This drawing is subject to change without notice.
  - C. This package can be hermetically sealed with a metal lid.
  - D. The terminals are gold plated.
  - E. Falls within JEDEC MS-004

P (R-PDIP-T8)

PLASTIC DUAL-IN-LINE PACKAGE



4040082/E 04/2010

- NOTES:
- A. All linear dimensions are in inches (millimeters).
  - B. This drawing is subject to change without notice.
  - C. Falls within JEDEC MS-001 variation BA.

D (R-PDSO-G8)

PLASTIC SMALL-OUTLINE PACKAGE

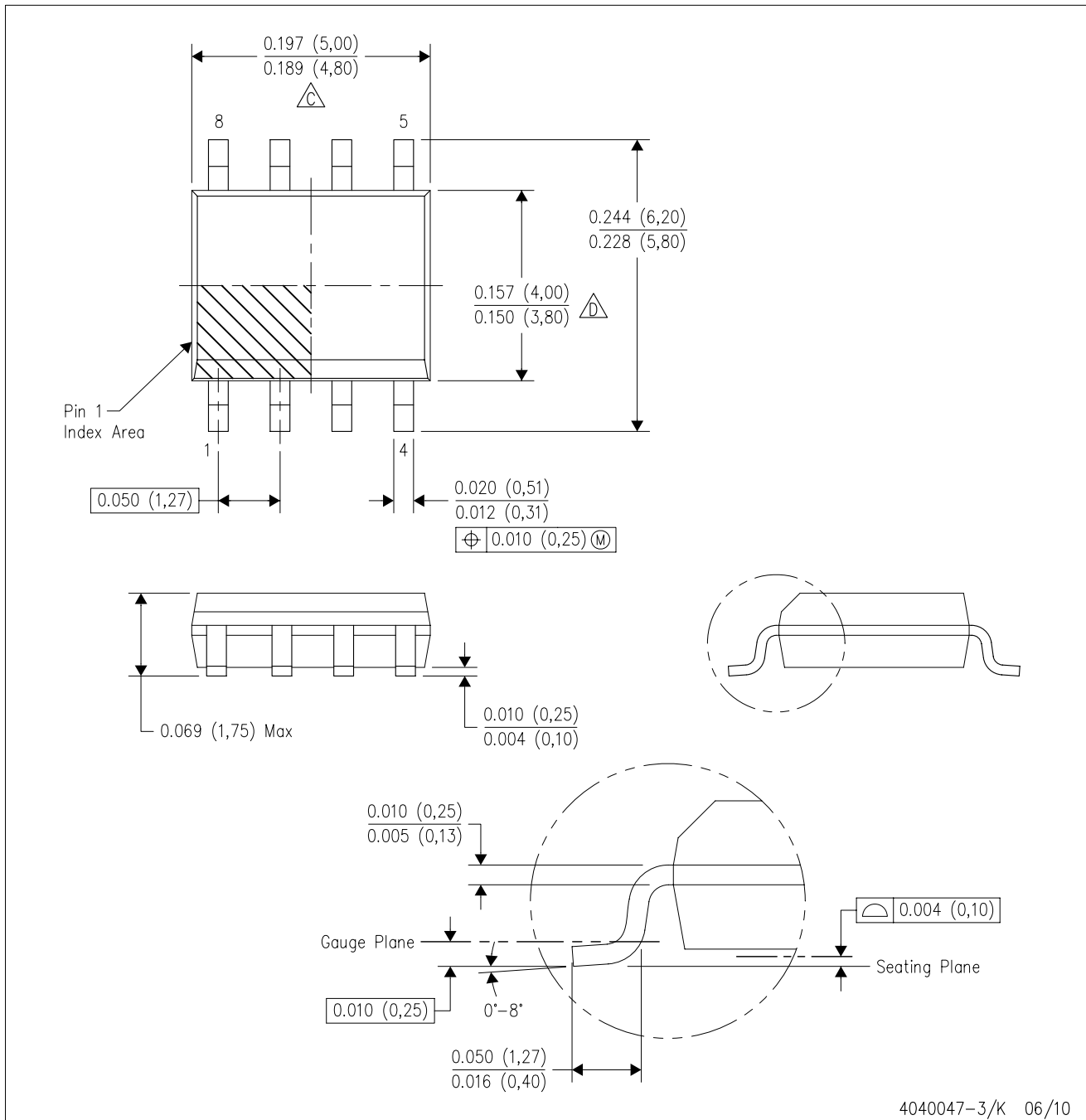

- NOTES:
- A. All linear dimensions are in inches (millimeters).
  - B. This drawing is subject to change without notice.
  - C. Body length does not include mold flash, protrusions, or gate burrs. Mold flash, protrusions, or gate burrs shall not exceed .006 (0,15) per end.
  - D. Body width does not include interlead flash. Interlead flash shall not exceed .017 (0,43) per side.
  - E. Reference JEDEC MS-012 variation AA.

DW (R-PDSO-G16)

PLASTIC SMALL-OUTLINE PACKAGE

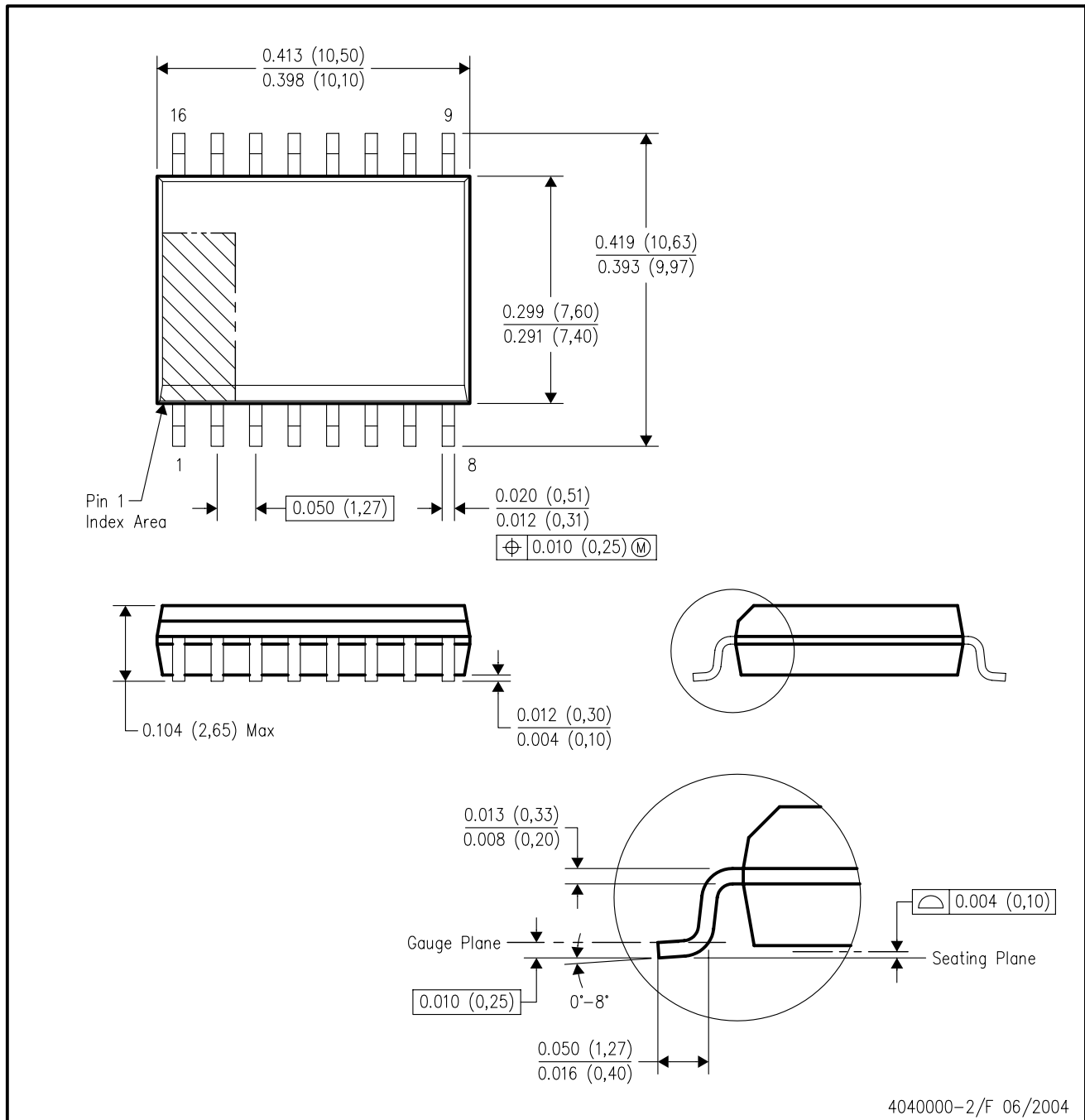

4040000-2/F 06/2004

- NOTES:
- A. All linear dimensions are in inches (millimeters).
  - B. This drawing is subject to change without notice.
  - C. Body dimensions do not include mold flash or protrusion not to exceed 0.006 (0,15).
  - D. Falls within JEDEC MS-013 variation AA.

# MECHANICAL DATA

PS (R-PDSO-G8)

PLASTIC SMALL-OUTLINE PACKAGE



- NOTES:
- A. All linear dimensions are in millimeters.
  - B. This drawing is subject to change without notice.
  - C. Body dimensions do not include mold flash or protrusion, not to exceed 0,15.



PW (R-PDSO-G\*\*)

PLASTIC SMALL-OUTLINE PACKAGE

14 PINS SHOWN



4040064/F 01/97

- NOTES: A. All linear dimensions are in millimeters.  
 B. This drawing is subject to change without notice.  
 C. Body dimensions do not include mold flash or protrusion not to exceed 0,15.  
 D. Falls within JEDEC MO-153

## IMPORTANT NOTICE

Texas Instruments Incorporated and its subsidiaries (TI) reserve the right to make corrections, modifications, enhancements, improvements, and other changes to its products and services at any time and to discontinue any product or service without notice. Customers should obtain the latest relevant information before placing orders and should verify that such information is current and complete. All products are sold subject to TI's terms and conditions of sale supplied at the time of order acknowledgment.

TI warrants performance of its hardware products to the specifications applicable at the time of sale in accordance with TI's standard warranty. Testing and other quality control techniques are used to the extent TI deems necessary to support this warranty. Except where mandated by government requirements, testing of all parameters of each product is not necessarily performed.

TI assumes no liability for applications assistance or customer product design. Customers are responsible for their products and applications using TI components. To minimize the risks associated with customer products and applications, customers should provide adequate design and operating safeguards.

TI does not warrant or represent that any license, either express or implied, is granted under any TI patent right, copyright, mask work right, or other TI intellectual property right relating to any combination, machine, or process in which TI products or services are used. Information published by TI regarding third-party products or services does not constitute a license from TI to use such products or services or a warranty or endorsement thereof. Use of such information may require a license from a third party under the patents or other intellectual property of the third party, or a license from TI under the patents or other intellectual property of TI.

Reproduction of TI information in TI data books or data sheets is permissible only if reproduction is without alteration and is accompanied by all associated warranties, conditions, limitations, and notices. Reproduction of this information with alteration is an unfair and deceptive business practice. TI is not responsible or liable for such altered documentation. Information of third parties may be subject to additional restrictions.

Resale of TI products or services with statements different from or beyond the parameters stated by TI for that product or service voids all express and any implied warranties for the associated TI product or service and is an unfair and deceptive business practice. TI is not responsible or liable for any such statements.

TI products are not authorized for use in safety-critical applications (such as life support) where a failure of the TI product would reasonably be expected to cause severe personal injury or death, unless officers of the parties have executed an agreement specifically governing such use. Buyers represent that they have all necessary expertise in the safety and regulatory ramifications of their applications, and acknowledge and agree that they are solely responsible for all legal, regulatory and safety-related requirements concerning their products and any use of TI products in such safety-critical applications, notwithstanding any applications-related information or support that may be provided by TI. Further, Buyers must fully indemnify TI and its representatives against any damages arising out of the use of TI products in such safety-critical applications.

TI products are neither designed nor intended for use in military/aerospace applications or environments unless the TI products are specifically designated by TI as military-grade or "enhanced plastic." Only products designated by TI as military-grade meet military specifications. Buyers acknowledge and agree that any such use of TI products which TI has not designated as military-grade is solely at the Buyer's risk, and that they are solely responsible for compliance with all legal and regulatory requirements in connection with such use.

TI products are neither designed nor intended for use in automotive applications or environments unless the specific TI products are designated by TI as compliant with ISO/TS 16949 requirements. Buyers acknowledge and agree that, if they use any non-designated products in automotive applications, TI will not be responsible for any failure to meet such requirements.

Following are URLs where you can obtain information on other Texas Instruments products and application solutions:

<b>Products</b>		<b>Applications</b>	
Amplifiers	<a href="http://amplifier.ti.com">amplifier.ti.com</a>	Audio	<a href="http://www.ti.com/audio">www.ti.com/audio</a>
Data Converters	<a href="http://dataconverter.ti.com">dataconverter.ti.com</a>	Automotive	<a href="http://www.ti.com/automotive">www.ti.com/automotive</a>
DLP® Products	<a href="http://www.dlp.com">www.dlp.com</a>	Communications and Telecom	<a href="http://www.ti.com/communications">www.ti.com/communications</a>
DSP	<a href="http://dsp.ti.com">dsp.ti.com</a>	Computers and Peripherals	<a href="http://www.ti.com/computers">www.ti.com/computers</a>
Clocks and Timers	<a href="http://www.ti.com/clocks">www.ti.com/clocks</a>	Consumer Electronics	<a href="http://www.ti.com/consumer-apps">www.ti.com/consumer-apps</a>
Interface	<a href="http://interface.ti.com">interface.ti.com</a>	Energy	<a href="http://www.ti.com/energy">www.ti.com/energy</a>
Logic	<a href="http://logic.ti.com">logic.ti.com</a>	Industrial	<a href="http://www.ti.com/industrial">www.ti.com/industrial</a>
Power Mgmt	<a href="http://power.ti.com">power.ti.com</a>	Medical	<a href="http://www.ti.com/medical">www.ti.com/medical</a>
Microcontrollers	<a href="http://microcontroller.ti.com">microcontroller.ti.com</a>	Security	<a href="http://www.ti.com/security">www.ti.com/security</a>
RFID	<a href="http://www.ti-rfid.com">www.ti-rfid.com</a>	Space, Avionics & Defense	<a href="http://www.ti.com/space-avionics-defense">www.ti.com/space-avionics-defense</a>
RF/IF and ZigBee® Solutions	<a href="http://www.ti.com/lprf">www.ti.com/lprf</a>	Video and Imaging	<a href="http://www.ti.com/video">www.ti.com/video</a>
		Wireless	<a href="http://www.ti.com/wireless-apps">www.ti.com/wireless-apps</a>