

Types 381L, 383L, 381LX & 383LX 105 °C High-Ripple Snap-In

2-pin Types: 381L and 381LX. 4-pin or 5-pin Types: 383L and 383LX



Adding longer-life and more ripple capability to the excellent value of Type 380L/LX capacitors, the 381L/LX readily handles tough switching power supply input and output circuits and motor-drive bus capacitor applications where the high surface area of multiple units in parallel equals the ripple capability of our Type 520C inverter-grade capacitor. Type 381LX delivers more capacitance per can size while Type 381L gives lower ESR for the same capacitance rating. Type 383L gives the choice of 4 or 5 leads for stable, reverseproof mounting. Type 383LX has 5 leads available.

Highlights

- Top performance in power supplies and motor drives
- 4 times the life of Type 380L/LX
- 2, 4 and 5 leads available
- Big selection of 42 case sizes

Specifications

Operating Temperature:	-40 °C to +105 °C up to 315 Vdc, -25 °C 350 Vdc and up
Rated Voltage:	10 to 450 Vdc
Capacitance:	33 µF to 150,000 µF ±20%
Leakage Current:	$\leq 3\sqrt{CV}$ µA

Ripple Current Multipliers:

Ambient Temperature

	45 °C	60 °C	70 °C	85 °C	105 °C
381L	2.70	2.60	2.50	2.10	1.00
381LX, 383 LX	2.35	2.20	2.00	1.70	1.00

Frequency

	50 Hz	60 Hz	120 Hz	500 Hz	1 kHz	5 kHz & up
10-100 Vdc	0.93	0.95	1.00	1.05	1.08	1.15
160-450 Vdc	0.75	0.80	1.00	1.20	1.25	1.40

EIA Ripple Life: 12,000 h @ 85 °C, Full load as per EIA IS-749

ΔCapacitance ±20%
ESR 200% of limit
DCL 100% of limit

Load Life Test:

3,000 h @ 105 °C, Full load

ΔCapacitance ±20%
ESR 200% of limit
DCL 100% of limit

Shelf Life:

1,000 h @ 105 °C

ΔCapacitance ±20%
DF 200% of limit
DCL 100% of limit

Vibration:

10 to 55 Hz, 0.06" and 10 g max, 2 h in each plane



RoHS
Compliant

Complies with the EU Directive 2002/95/EC requirement restricting the use of Lead (Pb), Mercury (Hg), Cadmium (Cd), Hexavalent chromium (Cr(VI)), PolyBrominated Biphenyls (PBB) and PolyBrominated Diphenyl Ethers (PBDE).

Types 381L, 383L, 381LX & 383LX 105 °C High-Ripple Snap-In

Outline Drawings

Two Pins

381L/LX (22 through 40 mm diameter)

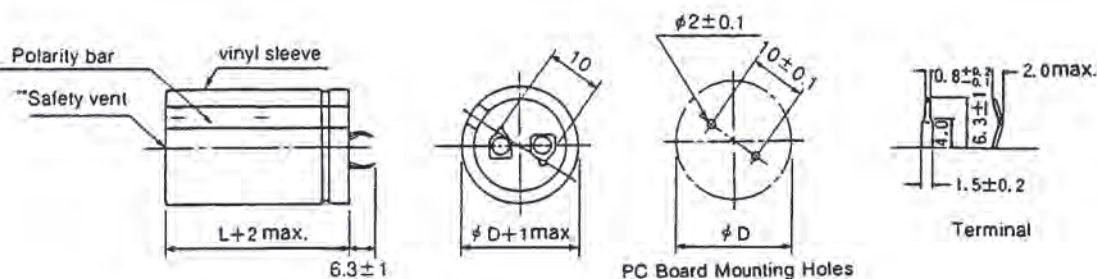

Four Pins

383L/LX (35 and 40mm diameter)

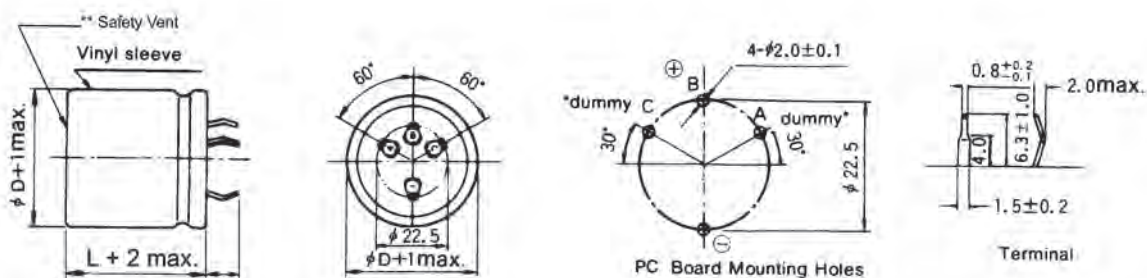

Five Pins

383L/LX (40 and 50mm diameter)

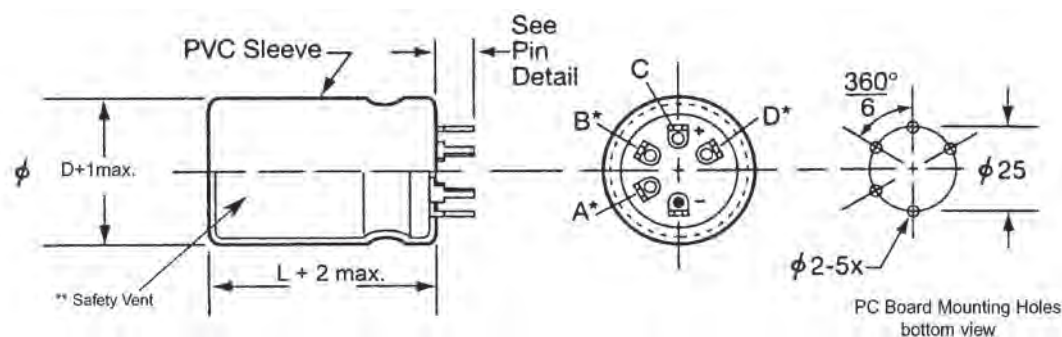

V Terminal Standoff Pin Dimensions

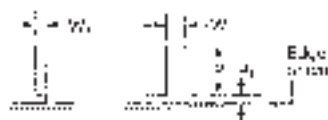

Type	P	P-	W	W ₁
V	3.75±0.10	0.6mm	1.5±0.1	0.7

Terminal	Connection	
	40 mm Dia.	50 mm Dia.
A	dummy	negative (-)
B	dummy	dummy
C	positive (+)	positive (+)
D	dummy	positive (+)
-	negative (-)	negative (-)

Notes:

* Use dummy terminals for mechanical support only. Make no electrical connection because they resistively connect through the electrolyte to the negative terminal.

** Safety Vent may be on the bottom or on the side of the can.

Types 381L, 383L, 381LX & 383LX 105 °C High-Ripple Snap-In

Insulated Case Dimensions

Case Code	DIAMETER "D"		LENGTH "L"		Typical Weight (grams)
	mm	inches	mm	inches	
H20	22	0.87	20	0.79	14
H01	22	0.87	25	0.98	16
H02	22	0.87	30	1.18	19
H03	22	0.87	35	1.38	22
H04	22	0.87	40	1.57	24
H45	22	0.87	45	1.77	28
H05	22	0.87	50	1.97	31
J20	25	0.98	20	0.79	16
J01	25	0.98	25	0.98	20
J02	25	0.98	30	1.18	24
J03	25	0.98	35	1.38	27
J04	25	0.98	40	1.57	31
J045	25	0.98	45	1.77	35
J05	25	0.98	50	1.97	38
K20	30	1.18	20	0.79	25
K01	30	1.18	25	0.98	30
K02	30	1.18	30	1.18	35
K03	30	1.18	35	1.38	40
K04	30	1.18	40	1.57	44
K45	30	1.18	45	1.77	48
K05	30	1.18	50	1.97	53
A20	35	1.38	20	0.79	35
A01	35	1.38	25	0.98	42
A02	35	1.38	30	1.18	48
A03	35	1.38	35	1.38	54
A04	35	1.38	40	1.57	62
A45	35	1.38	45	1.77	67
A05	35	1.38	50	1.97	74
A06	35	1.38	63	2.48	88
A07	35	1.38	70	2.76	98
A08	35	1.38	80	3.15	112
A10	35	1.38	105	4.13	144
N04	40	1.57	40	1.57	82
N05	40	1.57	50	1.97	105
N06	40	1.57	63	2.48	130
N08	40	1.57	80	3.15	185
N10	40	1.57	105	4.13	265
B05	50	1.97	50	1.97	136
B06	50	1.97	63	2.48	168
B08	50	1.97	80	3.15	239
B09	50	1.97	92	3.62	241
B10	50	1.97	105	4.13	325

Part Numbering System

383LX	472	M	200	N08	2	V
Type	Capacitance	Tolerance	Rated Voltage	Case Code	Insulation	5-pin Option
381L (2 pins)	100 = 10 µF	M = ±20%	Vdc		2 PVC	(383L/LX, 40 or 50 mm dia)
381LX (2 pins)	101 = 100 µF					blank = 4 pins
383L (4 or 5 pins)	492 = 4900 µF					V = 5 pins
383LX (4 or 5 pins)	433 = 43,000 µF					

Typical Performance Curves

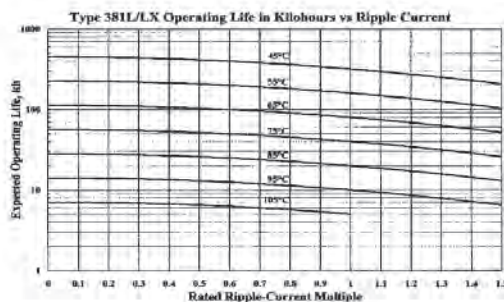
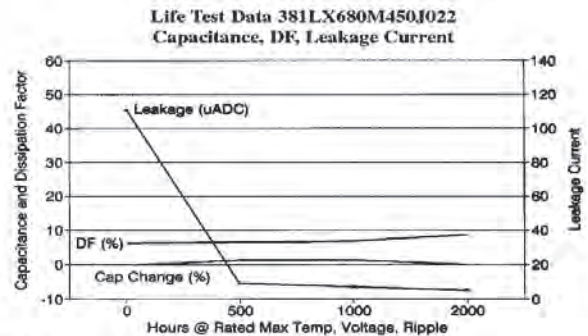
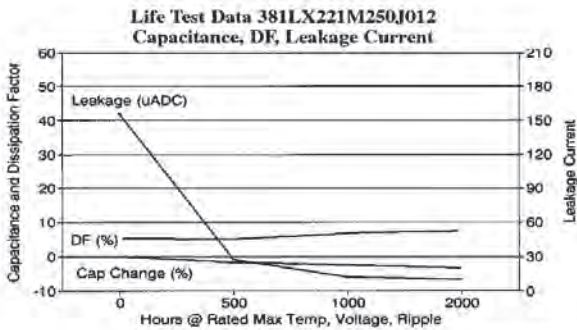



Types 381L, 383L, 381LX & 383LX 105 °C High-Ripple Snap-In

Ratings

Cap. (µF)	Catalog Part Number	ESR Max @ 25 °C		Ripple Amps @ 105 °C		Nominal Size D x L (mm)
		120 Hz (Ω)	20 kHz (Ω)	120 Hz (A)	20 kHz (A)	
4700	381LX472M010H012	0.159	0.135	.85	.98	22 x 25
6800	381LX682M010H012	0.111	0.093	1.30	1.50	22 x 25
10000	381LX103M010H012	0.075	0.063	1.80	2.10	22 x 25
12000	381LX123M010H022	0.061	0.053	2.20	2.50	22 x 30
15000	381LX153M010H032	0.055	0.045	2.30	2.60	22 x 35
15000	381LX153M010J012	0.055	0.045	2.30	2.60	25 x 25
18000	381LX183M010H042	0.044	0.038	2.40	2.80	22 x 40
18000	381LX183M010J022	0.044	0.038	2.40	2.80	25 x 30
22000	381LX223M010H452	0.040	0.032	2.60	3.00	22 x 45
22000	381LX223M010J032	0.040	0.032	2.60	3.00	25 x 35
22000	381LX223M010K012	0.040	0.032	2.60	3.00	30 x 25
27000	381LX273M010H052	0.033	0.028	3.10	3.60	22 x 50
27000	381LX273M010J042	0.033	0.028	3.10	3.60	25 x 40
27000	381LX273M010K022	0.033	0.028	3.10	3.60	30 x 30
27000	381LX273M010A012	0.033	0.028	3.10	3.60	35 x 25
33000	381LX333M010J452	0.030	0.023	3.40	3.90	25 x 45
33000	381LX333M010K032	0.030	0.023	3.40	3.90	30 x 35
33000	381LX333M010A022	0.030	0.023	3.40	3.90	35 x 30
39000	381LX393M010J052	0.025	0.020	3.70	4.30	25 x 50
39000	381LX393M010K042	0.025	0.020	3.70	4.30	30 x 40
39000	381LX393M010A022	0.025	0.020	3.70	4.30	35 x 30
47000	381LX473M010K452	0.023	0.020	4.20	4.80	30 x 45
47000	381LX473M010A032	0.023	0.020	4.20	4.80	35 x 35
56000	381LX563M010K052	0.022	0.019	5.00	5.80	30 x 50
56000	381LX563M010A042	0.022	0.019	5.00	5.80	35 x 40
68000	381LX683M010A052	0.021	0.020	5.50	6.30	35 x 50
68000	383LX683M010N042	0.023	0.022	5.40	6.20	40 x 40
82000	381L823M010A062	0.013	0.008	6.30	7.90	35 x 63
82000	383LX823M010N052	0.018	0.017	7.40	8.50	40 x 50
100000	381L104M010A072	0.011	0.007	7.30	9.00	35 x 70
120000	381L124M010A082	0.010	0.006	8.20	10.00	35 x 80
120000	383L124M010N062	0.012	0.008	7.10	8.60	40 x 63
150000	383L154M010N082	0.009	0.006	8.90	10.60	40 x 80
16 Vdc (20 Vdc Surge)						
3300	381LX332M016H202	0.216	0.170	1.30	1.50	22 x 20
3300	381LX332M016H012	0.176	0.141	1.30	1.50	22 x 25
4700	381LX472M016H012	0.123	0.099	1.52	1.75	22 x 25
4700	381LX472M016J202	0.150	0.120	1.60	1.80	25 x 20
6800	381LX682M016H012	0.088	0.067	2.20	2.50	22 x 25
6800	381LX682M016K202	0.105	0.080	1.80	2.10	30 x 20
8200	381LX822M016H022	0.070	0.055	2.40	2.80	22 x 30
10000	381LX103M016H022	0.070	0.050	2.60	3.00	22 x 30
10000	381LX103M016J012	0.070	0.050	2.60	3.00	25 x 25
10000	381LX103M016A202	0.070	0.057	2.40	2.80	35 x 20
12000	381LX123M016H032	0.055	0.044	2.90	3.30	22 x 35
12000	381LX123M016J022	0.055	0.044	2.90	3.30	25 x 30
12000	381LX123M016K012	0.055	0.044	2.90	3.30	30 x 25
15000	381LX153M016H042	0.046	0.037	3.20	3.70	22 x 40
15000	381LX153M016J032	0.046	0.037	3.20	3.70	25 x 35
15000	381LX153M016K022	0.046	0.037	3.20	3.70	30 x 30
18000	381LX183M016H452	0.040	0.034	3.50	4.00	22 x 45
18000	381LX183M016J042	0.040	0.034	3.50	4.00	25 x 40
18000	381LX183M016K022	0.040	0.034	3.50	4.00	30 x 30
18000	381LX183M016A012	0.040	0.034	3.50	4.00	35 x 25

Cap. (µF)	Catalog Part Number	ESR Max @ 25 °C		Ripple Amps @ 105 °C		Nominal Size D x L (mm)
		120 Hz (Ω)	20 kHz (Ω)	120 Hz (A)	20 kHz (A)	
22000	381LX223M016K032	0.033	0.028	3.80	4.40	30 x 35
22000	381LX223M016A022	0.033	0.028	3.80	4.40	35 x 30
27000	381LX273M016J052	0.030	0.025	4.20	4.80	25 x 50
27000	381LX273M016K042	0.030	0.025	4.20	4.80	30 x 40
27000	381LX273M016A022	0.030	0.025	4.20	4.80	35 x 30
33000	381LX333M016K452	0.023	0.020	4.70	5.40	30 x 45
33000	381LX333M016A032	0.023	0.020	4.70	5.40	35 x 35
39000	381LX393M016K052	0.022	0.020	5.10	5.90	30 x 50
39000	381LX393M016A042	0.022	0.020	5.10	5.90	35 x 40
47000	381LX473M016A452	0.020	0.018	5.50	6.30	35 x 45
47000	383LX473M016N042	0.020	0.018	5.50	6.33	40 x 40
56000	381LX563M016A052	0.019	0.017	6.00	6.90	35 x 50
68000	381LX683M016A062	0.017	0.015	6.60	7.60	35 x 63
68000	381L683M016A072	0.012	0.007	7.10	9.00	35 x 70
68000	383LX683M016N052	0.015	0.014	7.30	8.40	40 x 50
82000	381L823M016A082	0.010	0.007	8.00	10.00	35 x 80
82000	383LX823M016N062	0.017	0.013	7.70	8.80	40 x 63
100000	381LX104M016A082	0.015	0.013	8.00	9.20	35 x 80
120000	381LX124M016A102	0.014	0.012	8.71	10.02	35 x 105
120000	383LX124M016N082	0.014	0.012	8.80	10.10	40 x 80
120000	383LX124M016B052V	0.015	0.014	9.02	10.37	50 x 50
150000	383LX154M016N102	0.013	0.012	9.88	11.36	40 x 105
150000	383LX154M016B062V	0.014	0.013	10.15	11.67	50 x 63
180000	383LX184M016B082V	0.013	0.012	11.02	12.67	50 x 80
220000	383LX224M016B092V	0.012	0.011	11.71	13.47	50 x 92
250000	383LX254M016B102V	0.011	0.010	12.31	14.16	50 x 105
25 Vdc (32 Vdc Surge)						
2200	381LX222M025H202	0.240	0.180	1.30	1.50	22 x 20
2200	381LX222M025H012	0.240	0.180	1.30	1.50	22 x 25
3300	381LX332M025H012	0.160	0.120	1.60	1.80	22 x 25
3300	381LX332M025J202	0.160	0.120	1.60	1.80	25 x 20
4700	381LX472M025H012	0.105	0.080	2.00	2.30	22 x 25
4700	381LX472M025K202	0.110	0.085	1.80	2.10	30 x 20
5600	381LX562M025H022	0.090	0.070	2.20	2.50	22 x 30
6800	381LX682M025H022	0.070	0.055	2.40	2.80	22 x 30
6800	381LX682M025J012	0.070	0.055	2.40	2.80	25 x 25
6800	381LX682M025A202	0.080	0.060	2.30	2.60	35 x 20
8200	381LX822M025H032	0.060	0.045	2.70	3.10	22 x 35
8200	381LX822M025J022	0.060	0.045	2.70	3.10	25 x 30
8200	381LX822M025K012	0.060	0.045	2.70	3.10	30 x 25
10000	381LX103M025H042	0.050	0.040	3.00	3.50	22 x 40
10000	381LX103M025J032	0.050	0.040	3.00	3.50	25 x 35
10000	381LX103M025K022	0.050	0.040	3.00	3.50	30 x 30
12000	381LX123M025H452	0.044	0.033	3.20	3.68	22 x 45
12000	381LX123M025J042	0.044	0.033	3.20	3.70	25 x 40
12000	381LX123M025K022	0.044	0.033	3.20	3.70	30 x 30
12000	381LX123M025A012	0.044	0.033	3.20	3.70	35 x 25
15000	381LX153M025J452	0.036	0.031	3.60	4.10	25 x 45
15000	381LX153M025K032	0.036	0.031	3.60	4.10	30 x 35
15000	381LX153M025A022	0.036	0.031	3.60	4.10	35 x 30
18000	381LX183M025J052	0.030	0.027	3.90	4.50	25 x 50
18000	381LX183M025K042	0.030	0.027	3.90	4.50	30 x 40
18000	381LX183M025A032	0.030	0.027	3.90	4.50	35 x 35
22000	381LX223M025K452	0.025	0.022	4.30	4.90	30 x 45



Types 381L, 383L, 381LX & 383LX 105 °C High-Ripple Snap-In

Cap. (µF)	Catalog Part Number	ESR Max @ 25 °C		Ripple Amps @ 105 °C		Nominal Size D x L (mm)
		120 Hz (Ω)	20 kHz (Ω)	120 Hz (A)	20 kHz (A)	
27000	381LX273M025A452	0.021	0.019	4.80	5.50	35 x 45
27000	383L273M025N042	0.020	0.013	4.60	5.60	40 x 40
33000	381LX333M025A052	0.018	0.016	5.50	6.30	35 x 50
33000	383LX333M025N042	0.018	0.016	5.50	6.33	40 x 40
39000	381L393M025A062	0.014	0.009	6.10	7.60	35 x 63
39000	383L393M025N052	0.015	0.010	5.80	7.00	40 x 50
47000	381LX473M025A062	0.017	0.015	6.50	7.50	35 x 63
47000	381L473M025A072	0.012	0.008	7.10	8.70	35 x 70
47000	383LX473M025N052	0.015	0.014	6.50	7.40	40 x 50
47000	383L473M025N062	0.012	0.008	6.90	8.30	40 x 63
56000	381L563M025A082	0.010	0.007	7.90	9.70	35 x 80
56000	383LX563M025N062	0.015	0.012	7.20	8.25	40 x 63
68000	383L683M025N082	0.009	0.007	8.70	10.20	40 x 80
82000	381LX823M025A102	0.013	0.012	8.58	9.87	35 x 105
82000	383LX823M025N082	0.014	0.011	8.70	10.00	40 x 80
82000	383LX823M025B052V	0.016	0.015	9.20	10.58	50 x 50
100000	383LX104M025N102	0.012	0.010	9.76	11.22	40 x 105
100000	383LX104M025B062V	0.015	0.013	10.02	11.52	50 x 63
120000	383LX124M025B082V	0.013	0.012	10.93	12.57	50 x 80
150000	383LX154M025B092V	0.012	0.011	11.70	13.46	50 x 92
180000	383LX184M025B102V	0.010	0.009	12.42	14.28	50 x 105
35 Vdc (44 Vdc Surge)						
1500	381LX152M035H202	0.287	0.216	1.10	1.30	22 x 20
1500	381LX152M035H012	0.287	0.216	1.10	1.30	22 x 25
2200	381LX222M035H012	0.200	0.150	1.40	1.60	22 x 25
2200	381LX222M035J202	0.200	0.150	1.40	1.60	25 x 20
3300	381LX332M035H012	0.121	0.091	1.90	2.20	22 x 25
3300	381LX332M035K202	0.130	0.100	1.70	2.00	30 x 20
3900	381LX392M035H022	0.110	0.080	2.00	2.30	22 x 30
4700	381LX472M035H032	0.090	0.070	2.20	2.50	22 x 35
4700	381LX472M035J012	0.090	0.070	2.20	2.50	25 x 25
4700	381LX472M035A202	0.095	0.070	2.00	2.30	35 x 20
5600	381LX562M035H032	0.071	0.054	2.40	2.80	22 x 35
5600	381LX562M035J022	0.071	0.054	2.40	2.80	25 x 30
5600	381LX562M035K012	0.071	0.054	2.40	2.80	30 x 25
6800	381LX682M035H042	0.059	0.045	2.60	3.00	22 x 40
6800	381LX682M035J032	0.059	0.045	2.60	3.00	25 x 35
6800	381LX682M035K022	0.059	0.045	2.60	3.00	30 x 30
8200	381LX822M035H052	0.049	0.037	2.90	3.30	22 x 50
8200	381LX822M035J042	0.049	0.037	2.90	3.30	25 x 40
8200	381LX822M035K022	0.049	0.037	2.90	3.30	30 x 30
8200	381LX822M035A012	0.049	0.037	2.90	3.30	35 x 25
10000	381LX103M035J452	0.040	0.030	3.20	3.70	25 x 45
10000	381LX103M035K032	0.040	0.030	3.20	3.70	30 x 35
10000	381LX103M035A022	0.040	0.030	3.20	3.70	35 x 30
12000	381LX123M035J052	0.033	0.025	3.50	4.00	25 x 50
12000	381LX123M035K042	0.033	0.025	3.50	4.00	30 x 40
12000	381LX123M035A022	0.033	0.025	3.50	4.00	35 x 30
15000	381LX153M035K452	0.030	0.020	3.90	4.50	30 x 45
15000	381LX153M035A032	0.030	0.020	3.90	4.50	35 x 35
18000	381LX183M035A042	0.030	0.021	4.30	4.90	35 x 40
22000	381LX223M035A052	0.023	0.017	5.00	5.80	35 x 50
22000	383LX223M035N042	0.023	0.017	5.00	5.75	40 x 40
27000	381LX273M035A062	0.025	0.018	5.50	6.40	35 x 63

Cap. (µF)	Catalog Part Number	ESR Max @ 25 °C		Ripple Amps @ 105 °C		Nominal Size D x L (mm)
		120 Hz (Ω)	20 kHz (Ω)	120 Hz (A)	20 kHz (A)	
33000	381L333M035A072	0.014	0.009	6.40	8.10	35 x 70
33000	383L333M035N062	0.019	0.014	6.60	7.60	40 x 63
39000	381LX393M035A082	0.019	0.014	6.50	7.50	35 x 80
47000	381LX473M035A102	0.017	0.013	8.07	9.28	35 x 105
47000	383L473M035N082	0.018	0.013	7.80	9.00	40 x 80
47000	383LX473M035B052V	0.021	0.016	8.25	9.49	50 x 50
56000	383LX563M035B062V	0.019	0.014	9.07	10.43	50 x 63
68000	383LX683M035N102	0.016	0.012	9.27	10.66	40 x 105
68000	383LX683M035B082V	0.017	0.013	10.07	11.58	50 x 80
82000	383LX823M035B092V	0.015	0.011	10.89	12.52	50 x 92
100000	383LX104M035B102V	0.013	0.010	11.75	13.51	50 x 105
50 Vdc (63 Vdc Surge)						
1000	381LX102M050H202	0.260	0.200	.90	1.00	22 x 20
1000	381LX102M050H012	0.230	0.170	.90	1.00	22 x 25
1500	381LX152M050H012	0.155	0.120	1.25	1.45	22 x 25
1500	381LX152M050J202	0.177	0.130	1.20	1.40	25 x 20
1800	381LX182M050H012	0.129	0.097	1.50	1.70	22 x 25
2200	381LX222M050H022	0.105	0.080	1.70	2.00	22 x 30
2200	381LX222M050K202	0.121	0.090	1.40	1.60	30 x 20
2700	381LX272M050H022	0.086	0.064	1.80	2.10	22 x 30
2700	381LX272M050J012	0.086	0.064	1.80	2.10	25 x 25
3300	381LX332M050H032	0.070	0.053	2.00	2.30	22 x 35
3300	381LX332M050J022	0.070	0.053	2.00	2.30	25 x 30
3300	381LX332M050A202	0.085	0.064	1.70	2.00	35 x 20
3900	381LX392M050H042	0.065	0.050	2.20	2.50	22 x 40
3900	381LX392M050J032	0.065	0.050	2.20	2.50	25 x 35
3900	381LX392M050K012	0.065	0.050	2.20	2.50	30 x 25
4700	381LX472M050H452	0.053	0.040	2.50	2.90	22 x 45
4700	381LX471M050J042	0.053	0.040	2.50	2.90	25 x 40
4700	381LX472M050K022	0.053	0.040	2.50	2.90	30 x 30
4700	381LX472M050A012	0.053	0.040	2.50	2.90	35 x 25
5600	381LX562M050H052	0.050	0.038	2.80	3.20	22 x 50
5600	381LX562M050J042	0.050	0.038	2.80	3.20	25 x 40
5600	381LX562M050K032	0.050	0.038	2.80	3.20	30 x 35
5600	381LX562M050A022	0.050	0.038	2.80	3.20	35 x 30
6800	381LX682M050J052	0.046	0.035	3.30	3.80	25 x 50
6800	381LX682M050K042	0.046	0.035	3.30	3.80	30 x 40
6800	381LX682M050A022	0.046	0.035	3.30	3.80	35 x 30
8200	381LX822M050K452	0.040	0.030	3.60	4.10	30 x 45
8200	381LX822M050A032	0.040	0.030	3.60	4.10	35 x 35
10000	381LX103M050K052	0.033	0.025	4.00	4.60	30 x 50
10000	381LX103M050A042	0.033	0.025	4.00	4.60	35 x 40
12000	381LX123M050A452	0.028	0.021	4.50	5.20	35 x 45
12000	383L123M050N042	0.029	0.018	3.80	4.80	40 x 40
15000	381LX153M050A052	0.022	0.018	4.80	5.50	35 x 50
15000	381L153M050A062	0.020	0.012	5.10	6.50	35 x 63
15000	383LX153M050N042	0.022	0.018	4.80	5.52	40 x 40
15000	383L153M050N052	0.021	0.013	4.90	6.10	40 x 50
18000	381L183M050A072	0.017	0.010	5.90	7.50	35 x 70
18000	383L183M050N062	0.017	0.011	5.80	7.20	40 x 63
18000	381LX183M050A062	0.028	0.022	5.30	6.00	35 x 63
22000	381L223M050A082	0.014	0.009	6.70	8.40	35 x 80
22000	383LX223M050N052	0.016	0.013	5.10	5.90	40 x 50
27000	381LX273M050A082	0.015	0.012	6.20	7.10	35 x 80



Types 381L, 383L, 381LX & 383LX 105 °C High-Ripple Snap-In

Cap. (μF)	Catalog Part Number	ESR Max @ 25 °C		Ripple Amps @ 105 °C		Nominal Size D x L (mm)
		120 Hz (Ω)	20 kHz (Ω)	120 Hz (A)	20 kHz (A)	
27000	383L273M050N082	0.013	0.009	7.40	9.00	40 x 80
33000	381LX333M050A102	0.013	0.010	7.23	8.31	35 x 105
33000	383LX333M050B052V	0.018	0.014	7.75	8.91	50 x 50
39000	383LX393M050N082	0.013	0.010	6.20	7.10	40 x 80
39000	383LX393M050B062V	0.016	0.013	8.40	9.66	50 x 63
47000	383LX473M050N102	0.012	0.010	8.18	9.41	40 x 105
47000	383LX473M050B082V	0.014	0.011	9.19	10.57	50 x 80
56000	383LX563M050B092V	0.012	0.009	9.79	11.26	50 x 92
68000	383LX683M050B102V	0.011	0.009	10.40	12.00	50 x 105
63 Vdc (79 Vdc Surge)						
680	381LX681M063H202	0.463	0.350	.90	1.00	22 x 20
680	381LX681M063H012	0.410	0.310	.90	1.00	22 x 25
1000	381LX102M063H012	0.280	0.210	1.18	1.35	22 x 25
1000	381LX102M063J202	0.315	0.240	1.20	1.40	25 x 20
1200	381LX122M063H012	0.235	0.180	1.40	1.60	22 x 25
1500	381LX152M063H022	0.190	0.140	1.50	1.70	22 x 30
1500	381LX152M063K202	0.210	0.160	1.30	1.50	30 x 20
1800	381LX182M063H022	0.157	0.117	1.70	1.96	22 x 30
1800	381LX182M063J012	0.157	0.117	1.70	2.00	25 x 25
2200	381LX222M063H032	0.130	0.096	2.00	2.30	22 x 35
2200	381LX222M063J022	0.130	0.096	2.00	2.30	25 x 30
2200	381LX222M063A202	0.143	0.110	1.50	1.70	35 x 20
2700	381LX272M063H042	0.105	0.080	2.20	2.50	22 x 40
2700	381LX272M063J032	0.105	0.080	2.20	2.50	25 x 35
2700	381LX272M063K012	0.105	0.080	2.20	2.50	30 x 25
3300	381LX332M063H052	0.090	0.070	2.50	2.90	22 x 50
3300	381LX332M063J042	0.090	0.070	2.50	2.90	25 x 40
3300	381LX332M063K022	0.090	0.070	2.50	2.90	30 x 30
3300	381LX332M063A012	0.090	0.070	2.50	2.90	35 x 25
3900	381LX392M063J452	0.080	0.060	2.70	3.10	25 x 45
3900	381LX392M063K032	0.080	0.060	2.70	3.10	30 x 35
3900	381LX392M063A022	0.080	0.060	2.70	3.10	35 x 30
4700	381LX472M063J052	0.063	0.048	3.00	3.50	25 x 50
4700	381LX472M063K042	0.063	0.048	3.00	3.50	30 x 40
4700	381LX472M063A022	0.063	0.048	3.00	3.50	35 x 30
5600	381LX562M063K452	0.055	0.040	3.30	3.80	30 x 45
5600	381LX562M063A032	0.055	0.040	3.30	3.80	35 x 35
6800	381LX682M063K052	0.050	0.040	3.60	4.10	30 x 50
6800	381LX682M063A042	0.050	0.040	3.60	4.10	35 x 40
8200	381LX822M063A452	0.040	0.030	3.90	4.50	35 x 45
8200	383L822M063N042	0.031	0.018	3.70	4.80	40 x 40
10000	381LX103M063A052	0.033	0.028	4.40	5.10	35 x 50
12000	381LX123M063A052	0.030	0.025	4.40	5.10	35 x 50
12000	381L123M063A062	0.029	0.012	4.20	6.50	35 x 63
12000	383LX123M063N042	0.030	0.028	4.52	5.20	40 x 40
12000	383L123M063N052	0.022	0.013	4.70	6.10	40 x 50
15000	381LX153M063A062	0.024	0.021	4.90	5.70	35 x 63
15000	383LX153M063N052	0.027	0.023	4.80	5.50	40 x 50
15000	383L153M063N062	0.018	0.011	5.70	7.20	40 x 63
18000	381LX183M063A082	0.022	0.019	5.80	6.70	35 x 80
18000	383LX183M063N062	0.023	0.020	5.40	6.20	40 x 63
22000	383L223M063N082	0.013	0.009	7.20	9.00	40 x 80
22000	383LX223M063B052V	0.019	0.016	6.76	7.77	50 x 50

Cap. (μF)	Catalog Part Number	ESR Max @ 25 °C		Ripple Amps @ 105 °C		Nominal Size D x L (mm)
		120 Hz (Ω)	20 kHz (Ω)	120 Hz (A)	20 kHz (A)	
27000	383LX273M063N082	0.017	0.014	6.60	7.60	40 x 80
27000	383LX273M063B062V	0.017	0.014	7.34	8.44	50 x 63
33000	383LX333M063B082V	0.015	0.013	8.00	9.20	50 x 80
39000	383LX393M063N102	0.014	0.012	7.53	8.66	40 x 105
39000	383LX393M063B092V	0.014	0.012	8.48	9.75	50 x 92
47000	383LX473M063B102V	0.012	0.010	8.99	10.34	50 x 105
80 Vdc (100 Vdc Surge)						
470	381LX471M080H202	0.460	0.300	.80	.90	22 x 20
470	381LX471M080H012	0.390	0.270	.80	.90	22 x 25
680	381LX681M080H012	0.270	0.190	1.00	1.15	22 x 25
680	381LX681M080J202	0.317	0.206	1.00	1.20	25 x 25
820	381LX821M080H012	0.222	0.145	1.20	1.40	22 x 20
1000	381LX102M080H022	0.182	0.120	1.30	1.50	22 x 30
1000	381LX102M080J012	0.182	0.120	1.30	1.50	25 x 25
1000	381LX102M080K202	0.220	0.140	1.20	1.40	30 x 20
1200	381LX122M080H022	0.170	0.120	1.50	1.70	22 x 30
1200	381LX122M080J012	0.170	0.120	1.50	1.70	25 x 25
1500	381LX152M080H032	0.133	0.093	1.70	2.00	22 x 35
1500	381LX152M080J022	0.133	0.093	1.70	2.00	25 x 30
1500	381LX152M080A202	0.155	0.110	1.40	1.60	35 x 20
1800	381LX182M080H042	0.111	0.080	1.80	2.10	22 x 40
1800	381LX182M080J032	0.111	0.080	1.80	2.10	25 x 35
1800	381LX182M080K012	0.111	0.080	1.80	2.10	30 x 25
2200	381LX222M080H452	0.090	0.063	2.10	2.40	22 x 45
2200	381LX222M080J032	0.090	0.063	2.10	2.40	25 x 35
2200	381LX222M080K022	0.090	0.063	2.10	2.40	30 x 30
2200	381LX222M080A012	0.090	0.063	2.10	2.40	35 x 25
2700	381LX272M080J452	0.074	0.055	2.40	2.80	25 x 45
2700	381LX272M080K032	0.074	0.055	2.40	2.80	30 x 35
2700	381LX272M080A022	0.074	0.055	2.40	2.80	35 x 30
3300	381LX332M080J052	0.065	0.049	2.60	3.00	25 x 50
3300	381LX332M080K042	0.065	0.049	2.60	3.00	30 x 40
3300	381LX332M080A022	0.065	0.049	2.60	3.00	35 x 30
3900	381LX392M080K452	0.060	0.044	3.00	3.50	30 x 45
3900	381LX392M080A032	0.060	0.044	3.00	3.50	35 x 35
4700	381LX472M080K052	0.048	0.036	3.30	3.80	30 x 50
4700	381LX472M080A042	0.048	0.036	3.30	3.80	35 x 40
5600	381LX562M080A452	0.050	0.038	3.70	4.30	35 x 45
5600	383L562M080N042	0.035	0.022	3.50	4.40	40 x 40
6800	381LX682M080A052	0.041	0.031	3.90	4.50	35 x 50
6800	383LX682M080N042	0.041	0.031	3.90	4.49	40 x 40
8200	381L822M080A062	0.024	0.014	4.60	5.90	35 x 63
8200	383L822M080N052	0.025	0.016	4.40	5.60	40 x 50
10000	381L103M080A072	0.020	0.012	5.40	6.90	35 x 70
10000	383L103M080N062	0.021	0.013	5.30	6.70	40 x 63
12000	381L123M080A082	0.017	0.011	6.10	7.70	35 x 80
12000	383LX123M080B052V	0.035	0.026	6.03	6.93	50 x 50
15000	381LX153M080A102	0.024	0.018	6.13	7.05	35 x 105
15000	383L153M080N082	0.015	0.010	6.80	8.40	40 x 80
15000	383LX153M080B062V	0.028	0.021	6.65	7.65	50 x 63
18000	383LX183M080B082V	0.026	0.019	7.29	8.38	50 x 80
22000	383LX223M080N102	0.019	0.014	6.95	7.99	40 x 105
22000	383LX223M080B092V	0.022	0.016	7.83	9.00	50 x 92
27000	383LX273M080B102V	0.018	0.014	8.38	9.64	50 x 105



Types 381L, 383L, 381LX & 383LX 105 °C High-Ripple Snap-In

Cap. (µF)	Catalog Part Number	ESR Max @ 25 °C		Ripple Amps @ 105 °C		Nominal Size D x L (mm)
		120 Hz (Ω)	20 kHz (Ω)	120 Hz (A)	20 kHz (A)	
330	381LX331M100H202	0.653	0.392	.80	1.20	22 x 20
330	381LX331M100H012	0.550	0.330	.80	1.20	22 x 25
470	381LX471M100H012	0.390	0.230	.92	1.40	22 x 25
470	381LX471M100J202	0.460	0.275	1.00	1.50	25 x 20
560	381LX561M100H012	0.300	0.180	1.10	1.30	22 x 25
680	381LX681M100K202	0.317	0.190	1.10	1.70	30 x 20
820	381LX821M100H022	0.202	0.120	1.40	2.10	22 x 30
820	381LX821M100J012	0.202	0.120	1.40	2.10	25 x 25
1000	381LX102M100H032	0.182	0.110	1.70	2.55	22 x 35
1000	381LX102M100J022	0.182	0.110	1.70	2.55	25 x 30
1000	381LX102M100A202	0.216	0.130	1.20	1.80	35 x 20
1200	381LX122M100H042	0.152	0.091	1.80	2.70	22 x 40
1200	381LX122M100J032	0.152	0.091	1.80	2.70	25 x 35
1200	381LX122M100K012	0.152	0.091	1.80	2.70	30 x 25
1500	381LX152M100H452	0.122	0.073	2.10	3.15	22 x 45
1500	381LX152M100J042	0.122	0.073	2.10	3.15	25 x 40
1500	381LX152M100K022	0.122	0.073	2.10	3.15	30 x 30
1500	381LX152M100A012	0.122	0.073	2.10	3.15	35 x 25
1800	381LX182M100J452	0.111	0.072	2.30	3.45	25 x 45
1800	381LX182M100K032	0.111	0.072	2.30	3.45	30 x 35
1800	381LX182M100A022	0.111	0.072	2.30	3.45	35 x 30
2200	381LX222M100J052	0.090	0.060	2.60	3.90	25 x 50
2200	381LX222M100K042	0.090	0.060	2.60	3.90	30 x 40
2200	381LX222M100A022	0.090	0.060	2.60	3.90	35 x 30
2700	381LX272M100K452	0.080	0.052	2.90	4.35	30 x 45
2700	381LX272M100A032	0.080	0.052	2.90	4.35	35 x 35
3300	381LX332M100K052	0.075	0.053	3.20	4.80	30 x 50
3300	381LX332M100A042	0.075	0.053	3.20	4.80	35 x 40
3900	381LX392M100A452	0.064	0.045	3.60	5.40	35 x 45
4700	381LX472M100A052	0.053	0.040	3.80	5.70	35 x 50
4700	381L472M100A062	0.032	0.013	4.00	5.80	35 x 63
4700	383LX472M100N042	0.053	0.040	3.80	5.70	40 x 40
5600	381LX562M100A062	0.044	0.033	4.10	4.70	35 x 63
5600	381L562M100A072	0.027	0.011	4.70	6.70	35 x 70
5600	383L562M100N062	0.027	0.012	4.60	6.50	40 x 63
6800	381L682M100A082	0.023	0.010	5.30	7.50	35 x 80
6800	383LX682M100N052	0.037	0.027	4.60	5.30	40 x 50
8200	381LX822M100A082	0.030	0.023	5.15	5.90	35 x 80
8200	383LX822M100N062	0.030	0.023	5.00	5.77	40 x 63
8200	383L822M100N082	0.020	0.009	6.00	8.20	40 x 80
8200	383LX822M100B052V	0.030	0.023	6.14	7.06	50 x 50
10000	381LX103M100A102	0.025	0.019	6.38	7.34	35 x 105
12000	383LX123M100N082	0.021	0.016	6.44	7.40	40 x 80
12000	383LX123M100B062V	0.022	0.017	7.17	8.25	50 x 63
15000	383LX153M100N102	0.017	0.012	7.37	8.48	40 x 105
15000	383LX153M100B082V	0.019	0.014	8.01	9.21	50 x 80
18000	383LX183M100B092V	0.017	0.012	8.64	9.94	50 x 92
22000	383LX223M100B102V	0.015	0.011	9.32	10.72	50 x 105
160 Vdc (200 Vdc Surge)						
150	381LX151M160H202	1.437	0.647	.55	.77	22 x 20
150	381LX151M160H012	1.220	0.550	.60	.85	22 x 25
220	381LX221M160H012	0.830	0.370	.90	1.25	22 x 25
220	381LX221M160J202	0.980	0.441	.80	1.10	25 x 20
270	381LX271M160H012	0.675	0.304	1.10	1.50	22 x 25

Cap. (µF)	Catalog Part Number	ESR Max @ 25 °C		Ripple Amps @ 105 °C		Nominal Size D x L (mm)
		120 Hz (Ω)	20 kHz (Ω)	120 Hz (A)	20 kHz (A)	
330	381LX331M160K202	0.553	0.249	1.00	1.40	30 x 20
390	381LX391M160H022	0.553	0.249	1.30	1.80	22 x 30
390	381LX391M160J012	0.553	0.249	1.30	1.80	25 x 25
470	381LX471M160H022	0.423	0.190	1.40	2.00	22 x 30
470	381LX471M160A202	0.459	0.206	1.10	1.60	35 x 20
560	381LX561M160H032	0.355	0.160	1.50	2.10	22 x 35
560	381LX561M160J022	0.385	0.173	1.50	2.10	25 x 30
560	381LX561M160K012	0.385	0.173	1.50	2.10	30 x 25
680	381LX681M160H042	0.293	0.132	1.70	2.40	22 x 40
680	381LX681M160J022	0.293	0.132	1.70	2.40	25 x 30
820	381LX821M160H452	0.243	0.109	2.00	2.80	22 x 45
820	381LX821M160J032	0.243	0.109	2.00	2.80	25 x 35
820	381LX821M160K022	0.263	0.118	2.00	2.80	30 x 30
1000	381LX102M160H052	0.199	0.090	2.20	3.10	22 x 50
1000	381LX102M160J042	0.199	0.090	2.20	3.10	25 x 40
1000	381LX102M160K022	0.199	0.090	2.20	3.10	30 x 30
1000	381LX102M160A012	0.199	0.090	2.20	3.10	35 x 25
1200	381LX122M160J452	0.180	0.090	2.30	3.20	25 x 45
1200	381LX122M160K032	0.180	0.090	2.30	3.20	30 x 35
1200	381LX122M160A022	0.180	0.090	2.30	3.20	35 x 30
1500	381LX152M160K042	0.144	0.072	2.50	3.50	30 x 40
1500	381LX152M160A022	0.144	0.072	2.50	3.50	35 x 30
1800	381LX182M160K452	0.129	0.064	2.70	3.80	30 x 45
1800	381LX182M160A032	0.129	0.064	2.70	3.80	35 x 35
2200	381LX222M160A452	0.105	0.063	2.90	4.10	35 x 45
2200	381L222M160A062	0.050	0.027	3.30	4.50	35 x 63
2200	383LX222M160N042	0.100	0.060	2.90	4.10	40 x 40
2700	381LX272M160A052	0.086	0.052	3.10	4.40	35 x 50
2700	381L272M160A072	0.043	0.023	3.80	5.20	35 x 70
2700	383L272M160N062	0.045	0.027	3.80	5.00	40 x 63
3300	381L332M160A082	0.037	0.020	3.80	5.90	35 x 80
3300	383LX332M160N052	0.070	0.040	3.40	4.70	40 x 50
3900	383L392M160A082	0.029	0.017	4.90	6.30	40 x 80
180 Vdc (225 Vdc Surge)						
220	381LX221M180H012	0.904	0.461	1.00	1.40	22 x 25
270	381LX271M180H012	0.737	0.376	1.10	1.50	22 x 25
330	381LX331M180H022	0.603	0.308	1.20	1.70	22 x 30
330	381LX331M180J012	0.603	0.308	1.20	1.70	25 x 25
390	381LX391M180H022	0.510	0.260	1.30	1.80	22 x 30
390	381LX391M180J012	0.510	0.260	1.30	1.80	25 x 25
470	381LX471M180H032	0.423	0.216	1.40	2.00	22 x 35
470	381LX471M180J022	0.423	0.216	1.40	2.00	25 x 30
470	381LX471M180K012	0.423	0.216	1.40	2.00	30 x 25
560	381LX561M180H042	0.355	0.181	1.50	2.10	22 x 40
560	381LX561M180J022	0.355	0.181	1.50	2.10	25 x 30
560	381LX561M180J032	0.355	0.181	1.50	2.10	25 x 35
560	381LX561M180K012	0.355	0.181	1.50	2.10	30 x 25
680	381LX681M180H452	0.293	0.149	1.70	2.40	22 x 45
680	381LX681M180H052	0.293	0.149	1.70	2.40	22 x 50
680	381LX681M180J032	0.293	0.149	1.70	2.40	25 x 35
680	381LX681M180J042	0.293	0.149	1.70	2.40	25 x 40
680	381LX681M180K022	0.293	0.149	1.70	2.40	30 x 30
820	381LX821M180H052	0.243	0.124	2.00	2.80	22 x 50
820	381LX821M180J042	0.243	0.124	2.00	2.80	25 x 40



Types 381L, 383L, 381LX & 383LX 105 °C High-Ripple Snap-In

Cap. (µF)	Catalog Part Number	ESR Max @ 25 °C		Ripple Amps @ 105 °C		Nominal Size D x L (mm)
		120 Hz (Ω)	20 kHz (Ω)	120 Hz (A)	20 kHz (A)	
820	381LX821M180K022	0.243	0.124	2.00	2.80	30 x 30
820	381LX821M180K032	0.243	0.124	2.00	2.80	30 x 35
1000	381LX102M180J452	0.199	0.102	2.20	3.10	25 x 45
1000	381LX102M180K032	0.199	0.102	2.20	3.10	30 x 35
1000	381LX102M180K042	0.199	0.102	2.20	3.10	30 x 40
1000	381LX102M180A022	0.199	0.102	2.20	3.10	35 x 30
1200	381LX122M180J052	0.166	0.085	2.30	3.20	25 x 50
1200	381LX122M180K042	0.166	0.085	2.30	3.20	30 x 40
1200	381LX122M180K452	0.166	0.085	2.30	3.20	30 x 45
1200	381LX122M180A022	0.166	0.085	2.30	3.20	35 x 30
1500	381LX152M180K452	0.133	0.068	2.50	3.50	30 x 45
1500	381LX152M180K052	0.133	0.068	2.50	3.50	30 x 50
1500	381LX152M180A032	0.133	0.068	2.50	3.50	35 x 35
1500	381LX152M180A042	0.133	0.068	2.50	3.50	35 x 40
1800	381L182M180A062	0.055	0.028	3.20	4.50	35 x 63
1800	383L182M180N052	0.059	0.033	3.10	4.20	40 x 50
1800	381LX182M180A452	0.111	0.028	2.70	3.80	35 x 45
2200	381L222M180A072	0.046	0.024	3.70	5.20	35 x 70
2200	383L222M180N062	0.048	0.027	3.70	4.90	40 x 63
2200	381LX222M180A052	0.090	0.046	2.90	4.10	35 x 50
2700	381L272M180A082	0.039	0.021	4.30	5.90	35 x 80
3300	383L332M180N082	0.035	0.020	4.80	6.30	40 x 80
200 Vdc (250 Vdc Surge)						
100	381LX101M200H202	1.989	0.895	.50	.70	22 x 20
100	381LX101M200H012	1.660	0.750	.50	.70	22 x 25
150	381LX151M200H012	1.100	0.500	.70	.95	22 x 25
150	381LX151M200J202	1.326	0.600	.70	.90	25 x 20
220	381LX221M200H012	0.754	0.339	1.00	1.40	22 x 25
220	381LX221M200K202	0.904	0.407	.90	1.20	30 x 20
270	381LX271M200H022	0.614	0.276	1.10	1.50	22 x 30
270	381LX271M200J012	0.614	0.276	1.10	1.50	25 x 25
330	381LX331M200H022	0.603	0.308	1.20	1.70	22 x 30
330	381LX331M200J012	0.603	0.308	1.20	1.70	25 x 25
330	381LX331M200A202	0.603	0.271	1.10	1.50	35 x 20
390	381LX391M200H022	0.510	0.230	1.30	1.80	22 x 30
390	381LX391M200J012	0.510	0.230	1.30	1.80	25 x 25
470	381LX471M200H032	0.423	0.190	1.40	2.00	22 x 35
470	381LX471M200J022	0.423	0.190	1.40	2.00	25 x 30
470	381LX471M200K012	0.353	0.159	1.40	2.00	30 x 25
560	381LX561M200H042	0.355	0.160	1.50	2.10	22 x 40
560	381LX561M200J022	0.355	0.160	1.50	2.10	25 x 30
560	381LX561M200K012	0.355	0.160	1.50	2.10	30 x 25
680	381LX681M200H452	0.293	0.132	1.70	2.40	22 x 45
680	381LX681M200J032	0.293	0.132	1.70	2.40	25 x 35
680	381LX681M200K022	0.244	0.110	1.70	2.40	30 x 30
820	381LX821M200J452	0.263	0.118	2.00	2.80	25 x 45
820	381LX821M200K022	0.263	0.118	2.00	2.80	30 x 30
820	381LX821M200A012	0.263	0.118	2.00	2.80	35 x 25
1000	381LX102M200J052	0.216	0.108	2.20	3.10	25 x 50
1000	381LX102M200K032	0.216	0.108	2.20	3.10	30 x 35
1000	381LX102M200A022	0.216	0.108	2.20	3.10	35 x 30
1200	381LX122M200K042	0.193	0.097	2.30	3.20	30 x 40
1200	381LX122M200A032	0.193	0.097	2.30	3.20	35 x 35
1500	381LX152M200K052	0.155	0.077	2.50	3.50	30 x 50

Cap. (µF)	Catalog Part Number	ESR Max @ 25 °C		Ripple Amps @ 105 °C		Nominal Size D x L (mm)
		120 Hz (Ω)	20 kHz (Ω)	120 Hz (A)	20 kHz (A)	
1800	381LX182M200A452	0.129	0.077	2.70	3.80	35 x 45
1800	381L182M200A062	0.055	0.028	3.20	4.50	35 x 63
1800	383LX182M200N042	0.129	0.077	2.70	3.78	40 x 40
1800	383L182M200N052	0.063	0.033	3.00	4.10	40 x 50
2200	381LX222M200A052	0.105	0.063	2.90	4.00	35 x 50
2200	381L222M200A082	0.042	0.021	4.10	5.80	35 x 80
2200	383L222M200N062	0.051	0.027	3.60	4.90	40 x 63
2700	381LX272M200A062	0.080	0.047	3.65	5.11	35 x 63
2700	383LX272M200N052	0.086	0.052	3.55	4.97	40 x 50
2700	383L272M200N082	0.032	0.018	4.60	6.20	40 x 80
3300	381LX332M200A082	0.065	0.039	4.50	6.33	35 x 80
3300	383LX332M200N062	0.700	0.040	4.40	6.20	40 x 63
3300	383LX332M200B052V	0.075	0.045	5.20	7.28	50 x 50
3900	383LX392M200B062V	0.064	0.038	5.90	8.26	50 x 63
4700	381LX472M200A102	0.046	0.028	5.70	7.98	35 x 105
4700	383LX472M200N082	0.050	0.030	5.75	8.10	40 x 80
4700	383LX472M200B082V	0.053	0.032	6.82	9.55	50 x 80
5600	383LX562M200N102	0.041	0.025	6.76	9.46	40 x 105
5600	383LX562M200B092V	0.044	0.027	7.68	10.75	50 x 92
6800	383LX682M200B102V	0.034	0.020	8.71	12.19	50 x 105
250 Vdc (300 Vdc Surge)						
68	381LX680M250H202	2.926	1.493	.40	.60	22 x 20
68	381LX680M250H012	2.440	1.220	.40	.60	22 x 25
100	381LX101M250H012	1.660	0.830	.55	.78	22 x 25
100	381LX101M250J202	1.989	1.015	.50	.70	25 x 20
150	381LX151M250H012	1.330	0.660	.65	.90	22 x 25
150	381LX151M250K202	1.110	0.553	.75	1.05	30 x 20
180	381LX181M250H012	0.921	0.461	.90	1.26	22 x 25
220	381LX221M250H022	0.754	0.377	1.00	1.40	22 x 30
220	381LX221M250J012	0.754	0.377	1.00	1.40	25 x 25
220	381LX221M250A202	0.904	0.452	.90	1.20	35 x 20
270	381LX271M250H032	0.614	0.307	1.10	1.50	22 x 35
270	381LX271M250J022	0.614	0.307	1.10	1.50	25 x 30
270	381LX271M250K012	0.614	0.307	1.10	1.50	30 x 25
330	381LX331M250H042	0.502	0.251	1.20	1.70	22 x 40
330	381LX331M250J022	0.502	0.251	1.20	1.70	25 x 30
330	381LX331M250K012	0.502	0.251	1.20	1.70	30 x 25
390	381LX391M250H452	0.425	0.213	1.30	1.80	22 x 45
390	381LX391M250J032	0.425	0.213	1.30	1.80	25 x 35
390	381LX391M250K012	0.425	0.213	1.30	1.80	30 x 25
470	381LX471M250H052	0.353	0.176	1.40	2.00	22 x 50
470	381LX471M250J042	0.353	0.176	1.40	2.00	25 x 40
470	381LX471M250K022	0.353	0.176	1.40	2.00	30 x 30
560	381LX561M250J452	0.296	0.148	1.50	2.10	25 x 45
560	381LX561M250K032	0.296	0.148	1.50	2.10	30 x 35
560	381LX561M250A012	0.296	0.148	1.50	2.10	35 x 25
680	381LX681M250J052	0.244	0.134	1.70	2.38	25 x 50
680	381LX681M250K042	0.244	0.134	1.70	2.38	30 x 40
680	381LX681M250A022	0.244	0.134	1.70	2.38	35 x 30
820	381LX821M250A052	0.293	0.149	1.80	2.50	35 x 50
820	381LX821M250K452	0.202	0.111	2.00	2.80	30 x 45
820	381LX821M250A032	0.202	0.111	2.00	2.80	35 x 35
1000	381LX102M250K052	0.199	0.109	2.20	3.10	30 x 50
1000	381LX102M250A042	0.199	0.109	2.20	3.10	35 x 40



Types 381L, 383L, 381LX & 383LX 105 °C High-Ripple Snap-In

Cap. (µF)	Catalog Part Number	ESR Max @ 25 °C		Ripple Amps @ 105 °C		Nominal Size D x L (mm)
		120 Hz (Ω)	20 kHz (Ω)	120 Hz (A)	20 kHz (A)	
1200	383LX122M250N042	0.180	0.117	2.66	3.72	40 x 40
1200	383L122M250N052	0.081	0.031	2.60	4.30	40 x 50
1500	381LX152M250A052	0.144	0.093	2.50	3.50	35 x 50
1500	381L152M250A072	0.066	0.021	3.10	5.50	35 x 70
1800	381L182M250A082	0.057	0.018	3.60	6.30	35 x 80
1800	383LX182M250N052	0.120	0.078	3.25	4.55	40 x 50
1800	383L182M250N062	0.066	0.025	3.10	5.10	40 x 63
2200	381LX222M250A082	0.096	0.064	3.75	5.25	35 x 80
2200	383LX222M250N062	0.098	0.064	3.70	5.15	40 x 63
2200	383L222M250N082	0.043	0.017	4.00	6.40	40 x 80
2200	383LX222M250B052V	0.098	0.064	4.35	6.09	50 x 50
2700	381LX272M250A102	0.080	0.052	4.80	6.72	35 x 105
2700	383LX272M250N082	0.092	0.047	3.10	4.30	40 x 80
2700	383LX272M250B062V	0.080	0.052	4.98	6.97	50 x 63
3300	383LX332M250N082	0.065	0.042	4.86	6.80	40 x 80
3900	383LX392M250N102	0.055	0.036	5.61	7.85	40 x 105
3900	383LX392M250B082V	0.055	0.036	6.10	8.54	50 x 80
4300	383LX432M250B092V	0.050	0.033	6.67	9.34	50 x 92
4700	383LX472M250B102V	0.046	0.030	7.03	9.84	50 x 105
315 Vdc (365 Vdc Surge)						
82	381LX820M315H012	2.426	1.238	.60	.90	22 x 25
100	381LX101M315H022	1.989	1.015	.70	1.00	22 x 30
120	381LX121M315H022	1.658	0.846	.80	1.10	22 x 30
120	381LX121M315J012	1.658	0.846	.80	1.10	25 x 25
150	381LX151M315H032	1.326	0.677	.80	1.10	22 x 35
150	381LX151M315J022	1.326	0.677	.80	1.10	25 x 30
150	381LX151M315K012	1.326	0.677	.80	1.10	30 x 25
180	381LX181M315H042	1.105	0.564	.90	1.30	22 x 40
180	381LX181M315J022	1.105	0.564	.90	1.30	25 x 30
180	381LX181M315J032	1.105	0.564	.90	1.30	25 x 35
180	381LX181M315K012	1.105	0.564	.90	1.30	30 x 25
220	381LX221M315H452	0.904	0.461	1.00	1.40	22 x 45
220	381LX221M315J032	0.904	0.461	1.00	1.40	25 x 35
220	381LX221M315J042	0.904	0.461	1.00	1.40	25 x 40
220	381LX221M315K012	0.904	0.461	1.00	1.40	30 x 25
220	381LX221M315K022	0.904	0.461	1.00	1.40	30 x 30
270	381LX271M315H052	0.737	0.376	1.10	1.50	22 x 50
270	381LX271M315J042	0.737	0.376	1.10	1.50	25 x 40
270	381LX271M315J452	0.737	0.376	1.10	1.50	25 x 45
270	381LX271M315K022	0.737	0.376	1.10	1.50	30 x 30
270	381LX271M315K032	0.737	0.376	1.10	1.50	30 x 35
270	381L271M315K042	0.737	0.376	1.10	1.50	30 x 40
270	381LX271M315A022	0.737	0.376	1.10	1.50	35 x 30
330	381LX331M315J452	0.603	0.308	1.20	1.70	25 x 45
330	381LX331M315J052	0.603	0.308	1.20	1.70	25 x 50
330	381LX331M315K032	0.603	0.308	1.20	1.70	30 x 35
330	381LX331M315K042	0.603	0.308	1.20	1.70	30 x 40
330	381LX331M315A022	0.603	0.308	1.20	1.70	35 x 30
390	381LX391M315K452	0.510	0.260	1.30	1.80	30 x 45
390	381LX391M315A032	0.510	0.260	1.30	1.80	35 x 35
470	381LX471M315K452	0.423	0.216	1.40	2.00	30 x 45
470	381LX471M315K052	0.423	0.216	1.40	2.00	30 x 50
470	381LX471M315A032	0.423	0.216	1.40	2.00	35 x 35
470	381LX471M315A042	0.423	0.216	1.40	2.00	35 x 40

Cap. (µF)	Catalog Part Number	ESR Max @ 25 °C		Ripple Amps @ 105 °C		Nominal Size D x L (mm)
		120 Hz (Ω)	20 kHz (Ω)	120 Hz (A)	20 kHz (A)	
560	381LX561M315A042	0.355	0.181	1.50	2.10	35 x 40
560	381LX561M315A452	0.355	0.181	1.50	2.10	35 x 45
680	381LX681M315A452	0.293	0.149	1.70	2.40	35 x 45
680	381LX681M315A052	0.293	0.149	1.70	2.40	35 x 50
820	381L821M315A062	0.180	0.130	1.70	2.10	35 x 63
820	383L821M315N052	0.190	0.130	1.70	2.10	40 x 50
820	381LX821M315A052	0.242	0.030	2.00	2.80	35 x 50
1000	381L102M315A072	0.150	0.110	2.00	2.50	35 x 70
1200	381L122M315A082	0.130	0.089	2.30	2.80	35 x 80
1200	383L122M315N062	0.150	0.110	2.10	2.50	40 x 63
1500	383L152M315N082	0.110	0.055	2.70	3.20	40 x 80
350 Vdc (400 Vdc Surge)						
82	381LX820M350H012	2.426	1.238	.60	.90	22 x 25
100	381LX101M350H022	1.989	1.015	.70	1.00	22 x 30
100	381LX101M350J012	1.989	1.015	.70	1.00	25 x 25
120	381LX121M350H022	1.658	0.846	.80	1.10	22 x 30
120	381LX121M350J012	1.658	0.846	.80	1.10	25 x 25
150	381LX151M350H032	1.326	0.677	.80	1.10	22 x 35
150	381LX151M350J022	1.326	0.677	.80	1.10	25 x 30
150	381LX151M350K012	1.326	0.677	.80	1.10	30 x 25
180	381LX181M350H042	1.105	0.564	.90	1.30	22 x 40
180	381LX181M350J022	1.105	0.564	.90	1.30	25 x 30
180	381LX181M350K012	1.105	0.564	.90	1.30	30 x 25
220	381LX221M350H452	0.904	0.461	1.00	1.40	22 x 45
220	381LX221M350J032	0.904	0.461	1.00	1.40	25 x 35
220	381LX221M350K022	0.904	0.461	1.00	1.40	30 x 30
270	381LX271M350J452	0.737	0.376	1.10	1.50	25 x 45
270	381LX271M350K022	0.737	0.376	1.10	1.50	30 x 30
270	381LX271M350A012	0.737	0.376	1.10	1.50	35 x 25
330	381LX331M350J052	0.603	0.308	1.20	1.70	25 x 50
330	381LX331M350K042	0.603	0.308	1.20	1.70	30 x 40
330	381LX331M350A022	0.603	0.308	1.20	1.70	35 x 30
390	381LX391M350K452	0.510	0.260	1.30	1.80	30 x 45
390	381LX391M350A022	0.510	0.260	1.30	1.80	35 x 30
470	381LX471M350K052	0.423	0.216	1.40	2.00	30 x 50
470	381LX471M350A042	0.423	0.216	1.40	2.00	35 x 40
560	381LX561M350A452	0.355	0.181	1.50	2.10	35 x 45
560	383L561M350N042	0.299	0.205	1.30	1.50	40 x 40
680	381LX681M350A052	0.293	0.149	1.70	2.40	35 x 50
680	383LX681M350N042	0.317	0.127	2.30	3.22	40 x 40
820	381LX821M350A062	0.303	0.155	2.70	3.70	35 x 63
820	383LX821M350N052	0.303	0.155	2.70	3.70	40 x 50
1000	381L102M350A072	0.173	0.117	1.90	2.30	35 x 70
1000	383L102M350N062	0.170	0.117	2.00	2.40	40 x 63
1000	383LX102M350B052V	0.216	0.066	3.56	4.96	50 x 50
1200	381LX122M350A082	0.207	0.106	3.20	4.50	35 x 80
1200	383LX122M350N062	0.207	0.106	3.20	4.50	40 x 63
1500	381LX152M350A102	0.144	0.057	4.78	6.69	35 x 105
1500	383LX152M350N082	0.166	0.085	3.80	5.25	40 x 80
1500	383LX152M350B062V	0.144	0.057	4.16	5.82	50 x 63
1800	383LX182M350N102	0.120	0.048	5.23	7.32	40 x 105
1800	383LX182M350B082V	0.120	0.048	5.69	7.97	50 x 80
2000	383LX202M350B092V	0.108	0.043	6.34	8.88	50 x 92
2200	383LX222M350B102V	0.098	0.039	6.60	9.30	50 x 105

Types 381L, 383L, 381LX & 383LX 105 °C High-Ripple Snap-In

Cap. (μF)	Catalog Part Number	ESR Max @ 25 °C		Ripple Amps @ 105 °C		Nominal Size D x L (mm)
		120 Hz (Ω)	20 kHz (Ω)	120 Hz (A)	20 kHz (A)	
33	381LX330M400H202	5.024	1.760	.20	.30	22 x 20
33	381LX330M400H012	4.500	1.600	.30	.42	22 x 25
47	381LX470M400H012	2.800	1.000	.43	.60	22 x 25
47	381LX470M400J202	3.530	1.240	.30	.40	25 x 20
56	381LX560M400H012	2.360	0.830	.50	.70	22 x 25
68	381LX680M400H022	1.950	0.683	.60	.80	22 x 30
68	381LX680M400J012	1.950	0.683	.60	.80	25 x 25
68	381LX680M400K202	2.440	0.853	.40	.50	30 x 20
82	381LX820M400H022	2.022	0.071	.60	.90	22 x 30
82	381LX820M400J012	1.620	0.570	.60	.90	25 x 25
100	381LX101M400H022	1.658	0.580	.70	1.00	22 x 30
100	381LX101M400J012	1.658	0.580	.70	1.00	25 x 25
100	381LX101M400A202	1.658	0.580	.50	.70	35 x 20
120	381LX121M400H032	1.380	0.484	.80	1.10	22 x 35
120	381LX121M400J022	1.380	0.484	.80	1.10	25 x 30
120	381LX121M400K012	1.110	0.387	.80	1.10	30 x 25
150	381LX151M400H042	1.110	0.387	.80	1.10	22 x 40
150	381LX151M400J022	1.110	0.387	.80	1.10	25 x 30
150	381LX151M400K012	1.110	0.387	.80	1.10	30 x 25
180	381LX181M400H452	0.921	0.322	.90	1.30	22 x 45
180	381LX181M400J032	0.921	0.322	.90	1.30	25 x 35
180	381LX181M400K022	0.921	0.322	.90	1.30	30 x 30
180	381LX181M400A012	0.737	0.258	.90	1.30	35 x 25
220	381LX221M400J452	0.754	0.264	1.10	1.50	25 x 45
220	381LX221M400K022	0.754	0.264	1.10	1.50	30 x 30
220	381LX221M400A012	0.754	0.264	1.10	1.50	35 x 25
270	381LX271M400J052	0.614	0.215	1.20	1.70	25 x 50
270	381LX271M400K032	0.614	0.215	1.20	1.70	30 x 35
270	381LX271M400A022	0.614	0.215	1.20	1.70	35 x 30
330	381LX331M400K452	0.502	0.201	1.40	1.90	30 x 45
330	381LX331M400A032	0.502	0.201	1.40	1.90	35 x 35
390	381LX391M400K052	0.425	0.170	1.55	2.20	30 x 50
390	381LX391M400A042	0.425	0.170	1.55	2.20	35 x 40
470	381LX471M400A452	0.353	0.141	1.80	2.50	35 x 45
470	383LX471M400N042	0.353	0.141	1.80	2.50	40 x 40
560	381LX561M400A052	0.296	0.118	1.80	2.50	35 x 50
680	383LX681M400N052	0.244	0.098	2.20	3.00	40 x 50
820	381LX821M400A062	0.202	0.081	2.44	3.42	35 x 63
820	383LX821M400B052	0.202	0.081	2.58	3.61	40 x 50
820	383LX821M400B052V	0.202	0.081	3.20	4.40	50 x 50
1000	381LX102M400A082	0.202	0.081	3.00	4.20	35 x 80
1000	383LX102M400N062	0.202	0.081	3.00	4.20	40 x 63
1200	381LX122M400A102	0.138	0.055	3.80	5.30	35 x 105
1200	383LX122M400N082	0.138	0.055	3.80	5.30	40 x 80
1200	383LX122M400B062V	0.152	0.061	4.20	5.90	50 x 63
1500	383LX152M400N102	0.111	0.044	4.80	6.70	40 x 105
1500	383LX152M400B082V	0.122	0.049	5.20	7.30	50 x 80
1600	383LX162M400B092V	0.114	0.046	5.60	8.00	50 x 92
1800	383LX182M400B102V	0.101	0.041	6.48	9.10	50 x 105
420 Vdc (470 Vdc Surge)						
100	381LX101M420H022	1.820	0.820	.65	.90	22 x 30
100	381LX101M420J012	1.820	0.820	.65	.90	25 x 25
120	381LX121M420H032	1.500	0.680	.70	1.00	22 x 35
120	381LX121M420J022	1.500	0.680	.70	1.00	25 x 30
150	381LX151M420H042	1.220	0.550	.80	1.10	22 x 40
150	381LX151M420J022	1.220	0.550	.80	1.10	25 x 30
150	381LX151M420K012	1.220	0.550	.80	1.10	30 x 25
180	381LX181M420H452	1.000	0.450	.88	1.20	22 x 45
180	381LX181M420K022	1.000	0.450	.88	1.20	30 x 30
220	381LX221M420J452	0.750	0.260	1.10	1.50	25 x 45
220	381LX221M420K022	0.750	0.260	1.10	1.50	30 x 30
220	381LX221M420A012	0.750	0.260	1.10	1.50	35 x 25
270	381LX271M420J052	0.610	0.210	1.20	1.70	25 x 50
270	381LX271M420K032	0.610	0.210	1.20	1.70	30 x 35
270	381LX271M420A022	0.610	0.210	1.20	1.70	35 x 30
330	381LX331M420K452	0.500	0.200	1.35	1.90	30 x 45
330	381LX331M420A032	0.502	0.200	1.35	1.90	35 x 35
390	381LX391M420K052	0.420	0.170	1.55	2.18	30 x 50
390	381LX391M420A042	0.420	0.170	1.55	2.18	35 x 40
470	381LX471M420A452	0.350	0.141	1.75	2.45	35 x 45
470	383LX471M420N042	0.350	0.141	1.78	2.45	40 x 40
560	381LX561M420A052	0.300	0.120	1.80	2.50	35 x 50
680	383LX681M420N052	0.250	0.100	2.10	2.95	40 x 50
450 Vdc (500 Vdc Surge)						
56	381LX560M450H012	2.366	0.947	.40	.56	22 x 25
68	381LX680M450H022	1.950	0.780	.50	.70	22 x 30
68	381LX680M450J012	1.950	0.780	.50	.70	25 x 25
82	381LX820M450H022	3.235	1.651	.60	.80	22 x 30
82	381LX820M450J012	2.022	0.708	.56	.78	25 x 25
100	381LX101M450H032	1.660	0.580	.65	.90	22 x 35
100	381LX101M450J022	1.660	0.580	.65	.90	25 x 30
100	381LX101M450K012	1.660	0.580	.65	.90	30 x 25
120	381LX121M450H042	1.382	0.484	.70	1.00	22 x 40
120	381LX121M450J032	1.382	0.484	.70	1.00	25 x 35
120	381LX121M450K012	1.382	0.484	.70	1.00	30 x 25
150	381LX151M450H052	1.100	0.390	.80	1.10	22 x 50
150	381LX151M450J042	1.100	0.390	.80	1.10	25 x 40
150	381LX151M450K022	1.100	0.390	.80	1.10	30 x 30
150	381LX151M450A012	1.100	0.390	.80	1.10	35 x 25
180	381LX181M450J452	0.920	0.320	.90	1.20	25 x 45
180	381LX181M450K032	0.920	0.320	.90	1.20	30 x 35
220	381LX221M450J052	0.750	0.260	1.00	1.40	25 x 50
220	381LX221M450K042	0.750	0.260	1.00	1.40	30 x 40
220	381LX221M450A022	0.750	0.260	1.00	1.40	35 x 30
270	381LX271M450K452	0.614	0.246	1.20	1.70	30 x 45
270	381LX271M450A032	0.614	0.246	1.20	1.70	35 x 35
330	381LX331M450K052	0.502	0.201	1.40	1.90	30 x 50
330	381LX331M450A042	0.502	0.176	1.40	1.90	35 x 40
390	381LX391M450A452	0.425	0.150	1.60	2.20	35 x 45
390	383LX391M450N042	0.425	0.170	1.68	2.35	40 x 40
470	381LX471M450A052	0.353	0.123	1.70	2.40	35 x 50
470	383LX471M450N042	0.350	0.140	1.75	2.45	40 x 40
560	381LX561M450A062	0.296	0.104	2.20	3.00	35 x 70
560	383LX561M450N052	0.296	0.104	2.20	3.00	40 x 50
680	383L681M450A082	0.188	0.124	2.00	2.50	35 x 80
680	383LX681M450N062	0.244	0.085	2.50	3.50	40 x 63
680	383LX681M450B052V	0.244	0.085	2.90	4.06	50 x 50
820	383LX821M450A082	0.202	0.071	2.70	3.80	35 x 80
820	383LX821M450B062V	0.222	0.078	3.42	4.79	50 x 63
1000	381LX102M450A102	0.166	0.058	3.47	4.86	35 x 105
1000	383LX102M450N082	0.166	0.058	3.50	4.90	40 x 80
1200	383LX122M450N102	0.138	0.048	4.33	6.06	40 x 105
1200	383LX122M450B082V	0.152	0.053	4.70	6.58	50 x 80
1300	383LX132M450B092V	0.140	0.049	5.16	7.25	50 x 92
1500	383LX152M450B102V	0.122	0.043	6.03	8.44	50 x 105