

Title	<i>Reference Design Report for a 7.5 W Continuous, 13 W Peak DVD / Set Top Box Using TNY376PN</i>
Specification	85–265 VAC Input, 3.3 V (500 mA), 5 V (500 mA), 12 V (250 mA) and –12 V (30 mA) Outputs
Application	DVD / Set Top Box
Author	Power Integrations Applications Department
Document Number	RDR-115
Date	May 22, 2007
Revision	1.0

Summary and Features

- Excellent cross regulation without need for post regulator
- *EcoSmart*[®] – Meets Energy Star / CEC requirements
 - No-load consumption <150 mW at 265 VAC (no bias winding required)
 - > 70% active-mode efficiency
 - > 0.5 W output power available for 1 W input simplifies DVD player design
- BP/M capacitor value selects MOSFET current limit for greater design flexibility
- Tightly toleranced I²f parameter (–10%, +12%) reduces system cost:
 - Increases MOSFET and magnetics power delivery
 - Reduces overload power, which lowers output diode and capacitor costs
- Integrated *TinySwitch-PK* Safety/Reliability features:
 - Accurate (± 5%), auto-recovering, hysteretic thermal shutdown function maintains safe PCB temperatures under all conditions
 - Auto-restart protects against output short circuit and open loop fault conditions
 - > 3.2 mm creepage on package enables reliable operation in high humidity and high pollution environments
- Meets EN550022 and CISPR-22 Class B conducted EMI with >20 dB μ V margin

The products and applications illustrated herein (including circuits external to the products and transformer construction) may be covered by one or more U.S. and foreign patents or potentially by pending U.S. and foreign patent applications assigned to Power Integrations. A complete list of Power Integrations' patents may be found at www.powerint.com.



Table of Contents

1	Introduction	5
2	Power Supply Specification	6
3	Schematic	7
4	Circuit Description	8
4.1	Input EMI Filtering	8
4.2	TinySwitch-PK Primary	8
4.3	Output Feedback	9
4.4	Bypass/Multifunction Pin	9
5	PCB Layout	10
6	Bill of Materials	11
7	Transformer Specification	13
7.1	Electrical Diagram	13
7.2	Electrical Specifications	13
7.3	Materials	13
7.4	Transformer Build Diagram	14
7.5	Copper Foil Preparation	14
7.6	Transformer Construction	15
8	Design Spreadsheet	16
9	Performance Data	18
9.1	Efficiency	18
9.1.1	Active Mode CEC Measurement Data	18
9.2	No-load Input Power	19
9.3	Available Standby Output Power	20
9.4	Regulation	21
9.4.1	Load Regulation, Room Temperature, 115 VAC input.	21
9.4.2	Line	23
10	Thermal Performance	24
11	Waveforms	25
11.1	Drain Voltage and Current, Normal Operation	25
11.2	Output Voltage Start-up Profile	25
11.3	Drain Voltage and Current Start-up Profile	26
11.4	Load Transient Response	26
11.5	Output Ripple Measurements	29
11.5.1	Ripple Measurement Technique	29
11.5.2	Measurement Results	30
11.6	Line Surge	31
12	Conducted EMI	32
13	Appendix A	33
13.1	Output Power Delivery Using a TNY375P	33
14	Revision History	34



Important Note:

Although this board is designed to satisfy safety isolation requirements, the engineering prototype has not been agency approved. Therefore, all testing should be performed using an isolation transformer to provide the AC input to the prototype board.



1 Introduction

This document is an engineering report describing a four output flyback power supply utilizing a TNY376PN. This power supply is intended as a general purpose evaluation platform for *TinySwitch-PK*

The document contains the power supply specification, schematic, bill of materials, transformer documentation, printed circuit layout, and performance data.



Figure 1 – Populated Circuit Board Photograph.



2 Power Supply Specification

Description	Symbol	Min	Typ	Max	Units	Comment
Input						
Voltage	V_{IN}	85		265	VAC	2 Wire – no P.E.
Frequency	f_{LINE}	47	50/60	64	Hz	
No-load Input Power (230 VAC)				0.3	W	
Output						
Output Voltage 1	V_{OUT1}	3.135	3.3	3.465	V	± 5%
Output Ripple Voltage 1	$V_{RIPPLE1}$			100	mV	20 MHz bandwidth
Output Current 1	I_{OUT1}	0.1	0.5	0.6	A	
Output Voltage 2	V_{OUT2}	4.75	5.0	5.35	V	+7%, -5%
Output Ripple Voltage 2	$V_{RIPPLE2}$			66	mV	20 MHz bandwidth
Output Current 2	I_{OUT2}	0.2	0.5	0.6	A	
Output Voltage 3	V_{OUT3}	10.8	12.0	13.8	V	+15%, -10%
Output Ripple Voltage 3	$V_{RIPPLE3}$			240	mV	20 MHz bandwidth
Output Current 3	I_{OUT3}	0.1	0.25	0.64	A	
Output Voltage 4	V_{OUT4}	-10.8	-12.0	-13.8	V	+15%, -10%
Output Ripple Voltage 4	$V_{RIPPLE4}$			240	mV	20 MHz bandwidth
Output Current 4	I_{OUT4}	0.03	0.03	0.03	A	
Total Output Power						
Continuous Output Power	P_{OUT}		7.51		W	
Peak Output Power	P_{OUT_PEAK}		13		W	
Efficiency						
Standby input power	P_{sb}			1	W	$P_{out} = 0.5$ W, 264 VAC
No load input power	$P_{no\ load}$			300	mW	264 VAC
Environmental						
Conducted EMI		Meets CISPR22B / EN55022B				
Safety		Designed to meet IEC950, UL1950 Class III				
Surge		2			kV	1.2/50 μ s surge, IEC 1000-4-5, Class III Series Impedance: Differential Mode: 2 Ω Common Mode: 12 Ω
Surge		2.4			kV	100 kHz ring wave, 200 A short circuit current, 12 ohm common mode; 500 A 2 ohm differential
Ambient Temperature	T_{AMB}	0		50	$^{\circ}$ C	Free convection, sea level



3 Schematic

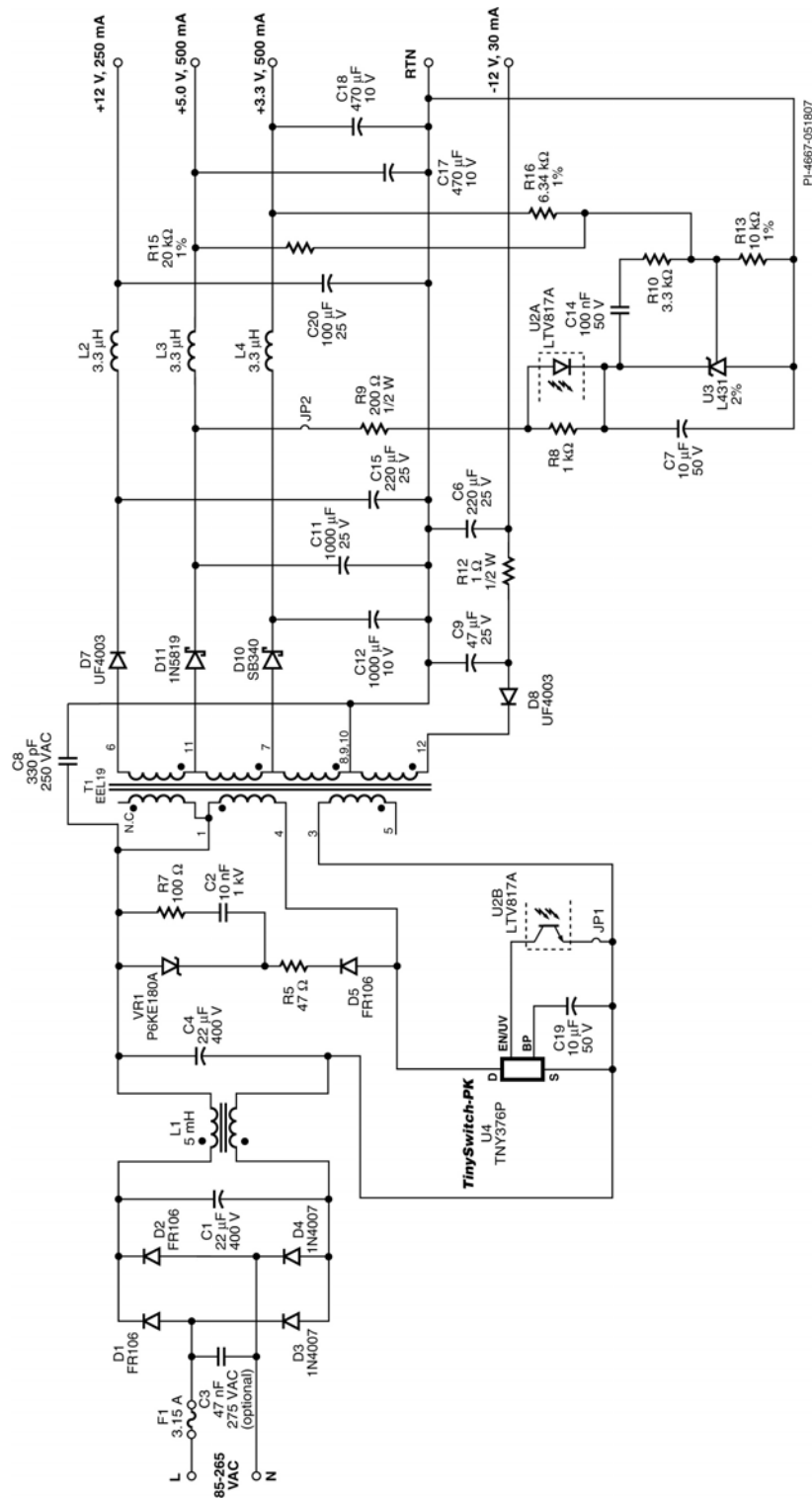

Figure 2 – Schematic.



4 Circuit Description

4.1 Input EMI Filtering

One requirement of this design was to meet conducted EMI with the output return connected to safety earth ground. This simulates the condition where the DVD player or set-top box is earth grounded either by an antenna or cable TV input cable.

The EMI filtering consists of a π filter formed by C1, L1 and C4 together with capacitor C8. A common mode choke was selected over discrete inductors for L1 to meet the earth grounded requirement. Such a simple arrangement was possible due to the switching frequency jitter feature of U4 and the E-Shield™ techniques used in the transformer. Provision for an additional X class capacitor (C3) is made on the board but is not required.

4.2 TinySwitch-PK Primary

The TNY376 (U4) has the following functions integrated onto a monolithic IC: a 700 V power MOSFET, a low-voltage CMOS controller, a high-voltage current source (provides startup and steady-state operational current to the IC), hysteretic thermal shutdown, and auto-restart. The excellent switching characteristics of the integrated power MOSFET allow efficient operation up to 132 kHz (264 kHz in Peak Power Mode).

Under normal operation, the rectified and filtered input voltage is applied to one side of the primary winding of T1. The other side of the T1 primary winding is connected to the DRAIN pin of U4. As soon as the voltage is applied across the DRAIN and SOURCE pins of U4, the internal high voltage current source (connected to the DRAIN pin of the IC) begins charging the capacitor (C19) connected to the BYPASS/MULTIFUNCTION (BP/M) pin. Once the voltage across C19 reaches 5.8 V, the controller enables MOSFET switching. MOSFET current is sensed (internally) by the voltage developed across the Drain to Source resistance ($R_{DS(ON)}$) while it is turned on. When the current reaches the preset (internal) current-limit trip point (I_{LIMIT}), the controller turns the MOSFET off.

The controller regulates the output voltage by skipping switching cycles (ON/OFF control) whenever the output voltage is above the reference level. During normal operation, MOSFET switching is disabled whenever the current flowing out of the EN/UV pin is greater than 90 μ A. If less than 90 μ A is flowing out of the EN/UV pin when the oscillator's (internal) clock signal occurs, MOSFET switching is enabled for that switching cycle, and the MOSFET turns on. That switching cycle terminates when the current through the MOSFET reaches I_{LIMIT} , or the DC_{MAX} signal is encountered. At full load, few switching cycles will be skipped (disabled) resulting in a high effective switching frequency. As the load reduces, more switching cycles are skipped, which reduces the effective switching frequency. At no-load, most switching cycles are skipped, which is what makes the no-load power consumption of supplies designed around the *TinySwitch-PK* family so low, since switching losses are the dominant loss mechanism at light loading. Additionally, since the amount of energy per switching cycle is fixed by



I_{LIMIT} , the skipping of switching cycles gives the supply a fairly consistent efficiency over the load range.

The *TinySwitch-PK* can supply additional output power to the load for short periods of time. If the MOSFET switching occurs for 14 consecutive clock cycles (132 kHz), the I_{LIMIT} increases, and the MOSFET is enabled to switch at 264 kHz. While in the Peak Power Mode of operation, if the MOSFET is disabled (via the feedback loop) for 12 consecutive clock cycles (264 kHz), then the *TinySwitch-PK* reverts back to its normal mode of operation at 132 kHz.

To limit the peak drain voltage spike caused by leakage inductance D5, R5, VR1, R7 and C2 form a clamp network. This arrangement offers the low EMI performance of an RCD clamp with the energy efficiency of a Zener clamp. By limiting the voltage across R7 and C2 using a Zener, the clamp voltage does not collapse as the output load, and therefore effective switching frequency, reduces. This prevents the clamp becoming a significant load at light load and therefore maintains high efficiency and low no-load input power.

4.3 Output Feedback

The output voltages of the +3.3 V and +5 V outputs are regulated by the sum of the currents through R15 and R16. The combined currents passing through R13 are regulated at 2.5 Volts by U3. If the voltage changes across R13, U3 changes the current through U2A (opto's LED), which proportionately changes the current through U2B (opto's transistor). If the collector current of U2B is greater than 90 μ A, U4 will skip the next switching cycle. If not, the switching cycle will occur. Sensing the outputs voltages via R15 and R16 helps improve the cross regulation between these outputs. The \pm 12 V outputs are cross regulated via the transformer's turns ratios. Optional capacitor C7 provides soft-finish, reducing the output voltage slew rate at start-up.

4.4 Bypass/Multifunction Pin

The *TinySwitch-PK*'s BP/M pin can be used to set the peak current limit of the primary switching cycle. This allows the designer more flexibility to optimize the power supply for the specific power range. Setting the current limit is done by selecting a capacitor value that is connected to the BP/M pin. The selection sizes are: 1.0 μ F, 0.1 μ F and 10 μ F. This sets the peak current threshold to the minimum, typical, and maximum level. Refer to the data sheet for the specific current limit for each *TinySwitch-PK* device.



5 PCB Layout

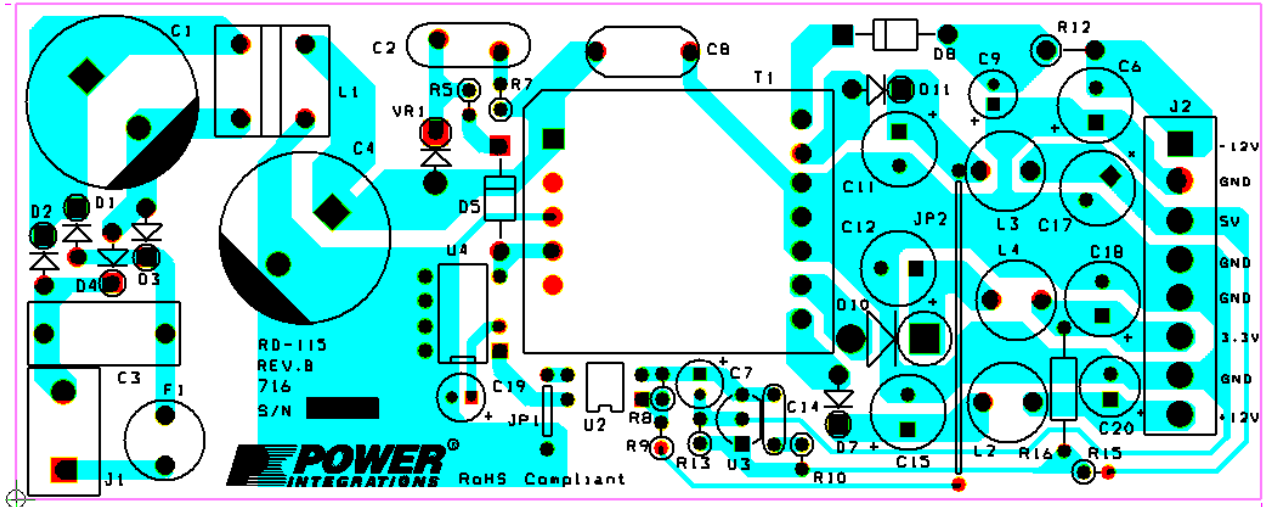

Figure 3 – Printed Circuit Layout.

6 Bill of Materials

Item	Qty	Part Reference	Value	Description	Mfg Part Number	Mfg
1	2	C1 C4	22 μ F	22 μ F, 400 V, Electrolytic, Low ESR, 901 m Ω , (16 x 20)	EKMX401ELL220ML20S	Nippon Chemi-Con
2	1	C2	10 nF	10 nF, 1 kV, Disc Ceramic	562R5HKMS10	Vishay/Sprague
3	1	C3	47 nF	47 nF, 275 VAC, Film, X2	ECQU2A473ML	Panasonic
4	2	C6 C15	220 μ F	220 μ F, 25 V, Electrolytic, Very Low ESR, 72 m Ω , (8 x 11.5)	EKZE250ELL221MHB5D	Nippon Chemi-Con
5	2	C7 C19	10 μ F	10 μ F, 50 V, Electrolytic, Gen. Purpose, (5 x 11)	EKMG500ELL100ME11D	Nippon Chemi-Con
6	1	C8	330 pF	330 pF, Ceramic Y1	440LT33-R	Vishay
7	1	C9	47 μ F	47 μ F, 25 V, Electrolytic, Very Low ESR, 300 m Ω , (5 x 11)	EKZE250ELL470ME11D	Nippon Chemi-Con
8	2	C11 C12	1000 μ F	1000 μ F, 10 V, Electrolytic, Very Low ESR, 41 m Ω , (8 x 20)	EKZE100ELL102MH20D	Nippon Chemi-Con
9	1	C14	100 nF	100 nF, 50 V, Ceramic, Z5U, .2 Lead Space	C317C104M5U5TA	Kemet
10	2	C17 C18	470 μ F	470 μ F, 10 V, Electrolytic, Very Low ESR, 72 m Ω , (8 x 11.5)	EKZE100ELL471MHB5D	Nippon Chemi-Con
11	1	C20	100 μ F	100 μ F, 25 V, Electrolytic, Very Low ESR, 130 m Ω , (6.3 x 11)	EKZE250ELL101MF11D	Nippon Chemi-Con
12	3	D1 D2 D5	FR106	800 V, 1 A, Fast Recovery Diode, 500 ns, DO-41	FR106	Diodes Inc.
13	2	D3 D4	1N4007	1000 V, 1 A, Rectifier, DO-41	1N4007	Vishay
14	2	D7 D8	UF4003	200 V, 1 A, Ultrafast Recovery, 50 ns, DO-41	UF4003-E3	Vishay
15	1	D10	SB340	40 V, 3 A, Schottky, DO-201AD	SB340-E3	Vishay
16	1	D11	1N5819	40 V, 1 A, Schottky, DO-41	1N5819-E3	Vishay
17	1	F1	3.15 A	3.15 A, 250 V, Fast, TR5	37013150410	Wickman
18	1	J1	CON2	2 Position (1 x 2) header, 0.312 pitch, Vertical	26-50-3039	Molex



19	1	J2	CON8	8 Position (1 x 8) header, 0.156 pitch, Vertical	26-48-1081	Molex
20	1	JP1	J	Wire Jumper, insulated, 22 AWG, 0.3 in,	298	Alpha
21	1	JP2	J	Wire Jumper, insulated, 22 AWG, 1.3 in	298	Alpha
22	1	L1	5 mH	5 mH, 0.3 A, Common Mode Choke	HT9V-03050	CUI
23	3	L2 L3 L4	3.3 uH	3.3 uH, 5.5 A	RL622-3R3K-RC	JW Miller
24	1	R5	47	47 R, 5%, 1/4 W, Carbon Film	CFR-25JB-47R	Yageo
25	1	R7	100	100 R, 5%, 1/4 W, Carbon Film	CFR-25JB-100R	Yageo
26	1	R8	1 k	1 k, 5%, 1/4 W, Carbon Film	CFR-25JB-1K0	Yageo
27	1	R9	200	200 R, 5%, 1/4 W, Carbon Film	CFR-25JB-200R	Yageo
28	1	R10	3.3 k	3.3 k, 5%, 1/4 W, Carbon Film	CFR-25JB-3K3	Yageo
29	1	R12	1	1 R, 5%, 1/2 W, Carbon Film	CFR-50JB-1R0	Yageo
30	1	R13	10 k	10 k, 1%, 1/4 W, Metal Film	ERO-S2PHF1002	Panasonic
31	1	R15	20 k	20 k, 1%, 1/4 W, Metal Film	MFR-25FBF-20K0	Yageo
32	1	R16	6.34 k	6.34 k, 1%, 1/4 W, Metal Film	MFR-25FBF-6K34	Yageo
33	1	T1	EEL19	Bobbin, EEL19, Horizontal, 12 pins (5 x 7)	Bobbin CWS-T1-DAK-115 SIL6041 TELP-32280-0001 R1396	Ngai Cheong Elect Ltd CWS Hical Precision Santronics
34	1	U2	LTV817A	Optocoupler, 35 V, CTR 80-160%, 4-DIP	LTV-817A	Liteon
35	1	U3	TL431	2.495 V Shunt Regulator IC, 2%, 0 °C to 70 °C, TO-92	TL431CLPG	On Semiconductor
36	1	U4	TNY376P	TinySwitch-PK, TNY376P, DIP-8C	TNY376P	Power Integrations
37	1	VR1	P6KE180 A	180 V, 5 W, 5%, TVS, DO204AC (DO-15)	P6KE180ARLG	On Semi

*A TNY375P can be used for U4, with a reduced power output. See Appendix A in this report.

Note: Parts listed above are RoHS compliant.



7 Transformer Specification

7.1 Electrical Diagram

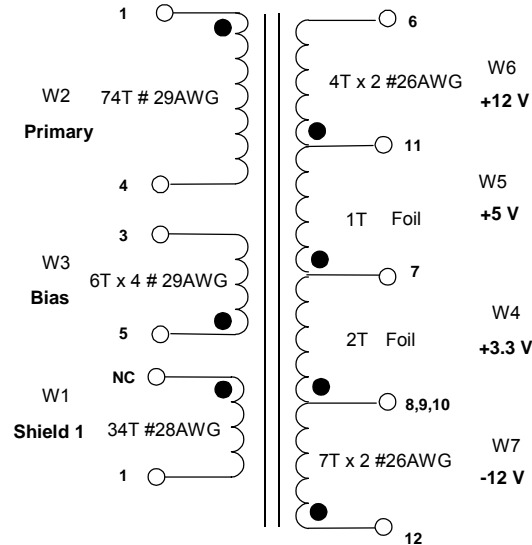

Figure 4 – Transformer Electrical Diagram.

7.2 Electrical Specifications

Electrical Strength	60Hz 1 second, from Pins 1-5 to Pins 6-12	3000 V ac
Primary Inductance	Pin 1 to Pin 4, all other windings open Measured at 132 kHz.	0.813 mH +/- 12%
Resonant Frequency	Pin 1 to Pin 4, all other windings open	300 kHz (Min.)
Primary Leakage Inductance	Pin 1 to Pin 4, Pins 6-12 shorted	30 μH Max.

7.3 Materials

Item	Description
[1]	Core: EEL19, Nicera NC-2H or equiv. gapped for AL of 150 nH/T ²
[2]	Bobbin: EEL19 Horizontal 12 pins
[3]	Magnet Wire: # 28 AWG
[4]	Magnet Wire: # 29 AWG
[5]	Magnet Wire: # 26 AWG
[6]	Teflon Tubing # 22
[7]	Margin Tape: 3M # 44 Polyester web. 3.0 mm wide
[8]	Copper Foil 0.52 mm thick, 12 mm wide.
[9]	Tape for Copper 2.0 mils thick, 16 mm wide.
[10]	Tape: 3M 1298 Polyester Film, 12.8 mm wide
[11]	Tape: 3M 1298 Polyester Film, 18.2 mm wide
[12]	Varnish



7.4 Transformer Build Diagram

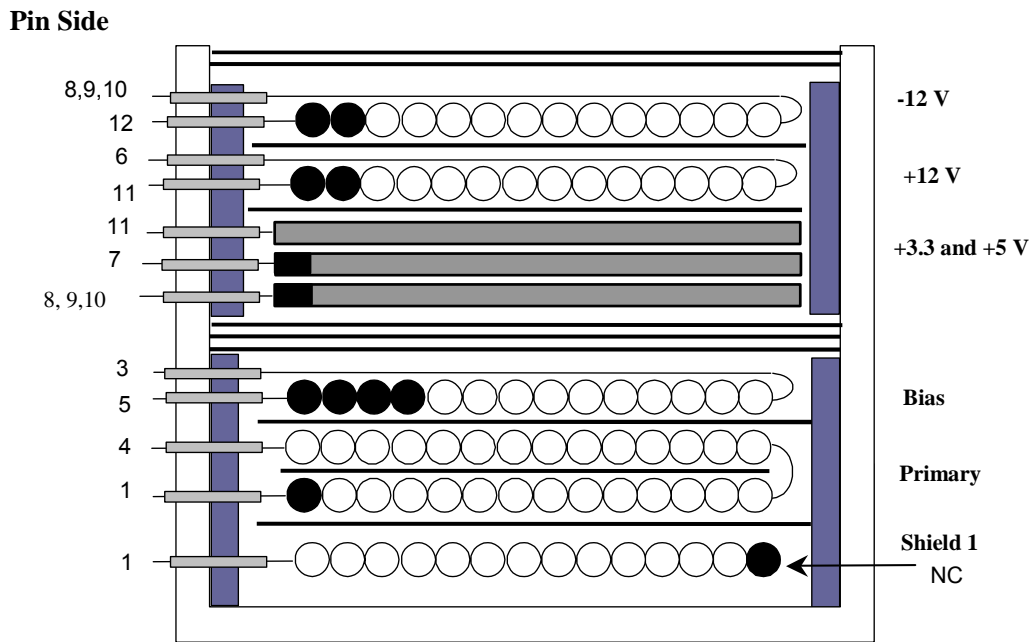

NC = No Connection to a pin

Figure 5 – Transformer Build Diagram.

7.5 Copper Foil Preparation

The following figure shows the copper foils to be used for +3.3 V and +5 V outputs (W4 and W5)

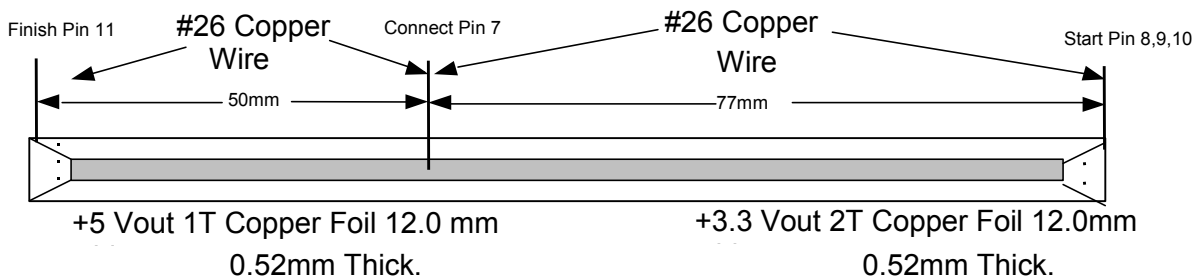

Figure 6 – Copper Foil Diagram.

7.6 Transformer Construction

Bobbin Set Up Orientation	Set up the bobbin with pin #1 oriented to the left-hand side.
Margin Tape	Apply 3.0 mm margin at each side of bobbin using item [7]. Match combined height of primary, shield and bias windings.
W1 Shield 1	Start with a floating lead temporary tie on pin 8. Wind 34 turns of item [3] from right to left. Wind tightly and uniformly across entire width of bobbin. Finish at pin 1 using item [6] at the finish leads. Remove the wire from pin 8 and cut the starting lead just at the starting of the winding.
Basic Insulation	Apply one layer of tape item [10].
W2 Two Layers Primary	Start on pin 1 using item [6] at the start leads. Wind 37 turns of item [4] from left to right. Apply one layer of item [10]. Continue the same wire on second layer. Wind 37 turns from right to left. The two layers should be wound tightly with the turns uniformly distributed across entire width of bobbin. Finish on pin 4 using item [6] at the finish leads.
Basic Insulation	Apply one layer of tape item [10].
W3 Bias	Start on pin 5 using item [6] at the start leads. Wind 6 turns of 4 parallel wires of item [4]. Wind from left to right in a single layer. The wires should be tightly and uniformly wound spread across the bobbin width. Finish on pin 3 using item [6] at the finish leads.
Insulation	Apply 3 Layers of tape [11] for insulation.
Margin Tape	Apply 3.0 mm margin at each side of bobbin using item [7]. Match combines height of secondary windings.
W4 and W5 +3.3 V and +5 V outputs.	Prepare copper foil item [8] and item [9] as shown in figure 6. Start at pin 8,9,10 using item [6] at the start leads. Wind 2 turns. Connect the second lead to pin 7 using item [6] at the finish leads; wind 1 turn. Connect the end lead to pin 11 using item [6] at the finish leads.
Basic Insulation	Apply one layer of tape item [10].
W6 +12 V out	Start on pin 11 using item [6] at the start leads. Wind 4 turns of Bifilar wires of item [5]. Wind from right to left in a single tightly wound spread across the bobbin width. Finish on pin 6 using item [6] at the finish leads.
Basic Insulation	Apply one layer of tape item [10].
W7 -12 V output.	Start at pin 12 using item [6] at the start leads. Wind 7 turns of Bifilar wires of item [5]. Wind from right to left in a uniform and tightly wound spread across the bobbin width. Finish on pin 8,9,10 using item [6] at the finish leads.
Outer Insulation	2 Layers of tape [11] for insulation.
Core Assembly	Assemble and secure core halves. Item [1]
Final Assembly	Dip Varnish uniformly in item [12].



8 Design Spreadsheet

ACDC_TinySwitch-PK_041207; Rev.0.22; Copyright Power Integrations 2007		INPUT	INFO	OUTPUT	UNIT	ACDC_TinySwitch-PK_041207_Rev0-22.xls; TinySwitch-PK Continuous/Discontinuous Flyback Transformer Design Spreadsheet
ENTER APPLICATION VARIABLES						
VACMIN	85				Volts	Minimum AC Input Voltage
VACMAX	265				Volts	Maximum AC Input Voltage
fL	50				Hertz	AC Mains Frequency
VO	5.00				Volts	Output Voltage (at continuous power)
Peak Load Current, IO	2.60				Amps	Power Supply Output Current (corresponding to peak power)
Peak Power			13.00		Watts	Peak Output Power. Used in estimation of Primary inductance
Continuous / Average Power	7.5		7.5		Watts	Continuous/Average Output Power. Used in estimation of Core size
n	0.67					Efficiency Estimate at output terminals. Under 0.7 if no better data available
Z			0.6			Z Factor. Ratio of secondary side losses to the total losses in the power supply. Use 0.6 if no better data available
tC	3.00				mSeconds	Bridge Rectifier Conduction Time Estimate
CIN	44.00		44		uFarads	Input Capacitance
ENTER TinySwitch-PK VARIABLES						
TinySwitch-PK	TNY376		TNY376			User defined TinySwitch-PK
Chosen Device		TNY376				
Chose Configuration	INC		Increase d Current Limit			Enter "RED" for reduced current limit (sealed adapters), "STD" for standard current limit or "INC" for increased current limit (peak or higher power applications)
ILIMITMIN			0.465		Amps	Minimum Current Limit
ILIMITTYP			0.500		Amps	
ILIMITMAX			0.535		Amps	Maximum Current Limit
fSmin			248000		Hertz	Minimum Device Switching Frequency
I ² fmin			59.40		A ² kHz	I ² f (product of current limit squared and frequency is trimmed for tighter tolerance)
PO_132kHz			8.77		Watts	Estimated Maximum Power while still in 132 kHz operation
VOR	135.00		135		Volts	Reflected Output Voltage (VOR < 135 V Recommended)
VDS			10		Volts	TinySwitch-PK on-state Drain to Source Voltage
VD			0.5		Volts	Output Winding Diode Forward Voltage Drop
KP			0.53			Ripple to Peak Current Ratio (KP < 6)
KP_TRANSIENT			0.36			Transient Ripple to Peak Current Ratio. Ensure KP_TRANSIENT > 0.25
ENTER BIAS WINDING VARIABLES						
VB			22.00		Volts	Bias Winding Voltage
VDB			0.70		Volts	
NB			12.00			Bias Winding Number of Turns
VZOV			28.00		Volts	Over Voltage Protection zener diode.
UVLO VARIABLES						
V_UV_TARGET			100.07		Volts	Target under-voltage threshold, above which the power supply will start
V_UV_ACTUAL			914.70		Volts	Typical start-up voltage based on standard value of RUV_ACTUAL
RUV_IDEAL			3.91		Mohms	Calculated value for UV Lockout resistor
RUV_ACTUAL			36.50		Mohms	Closest standard value of resistor to RUV_IDEAL
ENTER TRANSFORMER CORE/CONSTRUCTION VARIABLES						
Core Type	EEL19		EEL19			User defined Core Size (Verify thermal performance under



					continuous load conditions)
Core		EEL19		P/N:	PC40EE19/27/5-Z
Bobbin		EEL19_BOBBIN		P/N:	EEL19_BOBBIN
AE			0.2454	cm^2	Core Effective Cross Sectional Area
LE			6.185	cm	Core Effective Path Length
AL			720	nH/T^2	Ungapped Core Effective Inductance
BW			19.7	mm	Bobbin Physical Winding Width
M	3.00		3	mm	Safety Margin Width (Half the Primary to Secondary Creepage Distance)
L	2.00		2		Number of Primary Layers
NS			3		Number of Secondary Turns
DC INPUT VOLTAGE PARAMETERS					
VMIN			91	Volts	Minimum DC Input Voltage
VMAX			375	Volts	Maximum DC Input Voltage
CURRENT WAVEFORM SHAPE PARAMETERS					
DMAX			0.63		Duty Ratio at full load, minimum primary inductance and minimum input voltage
IAVG			0.24	Amps	Average Primary Current
IP			0.47	Amps	Minimum Peak Primary Current
IR			0.25	Amps	Primary Ripple Current
IRMS			0.32	Amps	Primary RMS Current
TRANSFORMER PRIMARY DESIGN PARAMETERS					
LP			813	uHenries	Typical Primary Inductance. +/- 12% to ensure a minimum primary inductance of 725 uH
LP_TOLERANCE			12	%	Primary inductance tolerance
NP			74		Primary Winding Number of Turns
ALG			150	nH/T^2	Gapped Core Effective Inductance
BM			2406	Gauss	Maximum Operating Flux Density at LP_TYP and ILIMITMAX, BM<3200 is recommended
BAC			641	Gauss	AC Flux Density for Core Loss Curves (0.5 X Peak to Peak)
ur			1444		Relative Permeability of Ungapped Core
LG			0.16	mm	Gap Length (Lg > 0.1 mm)
BWE			27.4	mm	Effective Bobbin Width
OD			0.37	mm	Maximum Primary Wire Diameter including insulation
INS			0.06	mm	Estimated Total Insulation Thickness (= 2 * film thickness)
DIA			0.31	mm	Bare conductor diameter
AWG			29	AWG	Primary Wire Gauge (Rounded to next smaller standard AWG value)
CM			128	Cmils	Bare conductor effective area in circular mils
CMA			404	Cmils/Amp	Primary Winding Current Capacity (200 < CMA < 500)
TRANSFORMER SECONDARY DESIGN PARAMETERS					
Lumped parameters					
ISP			11.41	Amps	Peak Secondary Current
ISRMS			6.03	Amps	Secondary RMS Current
IRIPPLE			5.44	Amps	Output Capacitor RMS Ripple Current
CMS			1206	Cmils	Secondary Bare Conductor minimum circular mils
AWGS			19	AWG	Secondary Wire Gauge (Rounded up to next larger standard AWG value)
VOLTAGE STRESS PARAMETERS					
VDRAIN			678	Volts	Maximum Drain Voltage Estimate (Assumes 20% zener clamp tolerance and an additional 10% temperature tolerance)
PIVS			20	Volts	Output Rectifier Maximum Peak Inverse Voltage



9 Performance Data

All measurements performed at room temperature, 60 Hz input frequency.

9.1 Efficiency

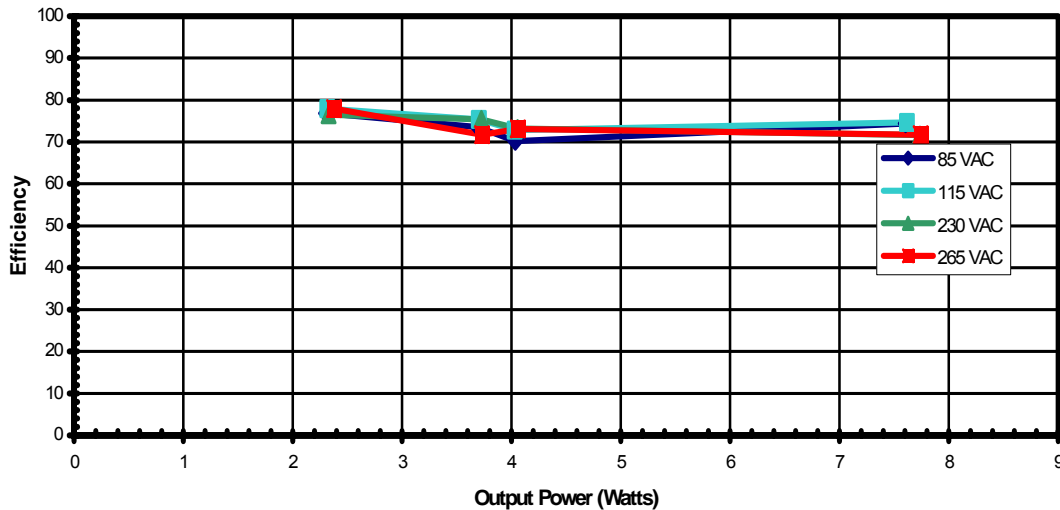

Figure 7 – Efficiency vs. Output Power, Room Temperature, 60 Hz.

9.1.1 Active Mode CEC Measurement Data

All single output adapters, including those provided with products, for sale in California after Jan 1st, 2007 must meet the California Energy Commission (CEC) requirement for minimum active mode efficiency and no load input power. Minimum active mode efficiency is defined as the average efficiency of 25, 50, 75 and 100% of rated output power with the limit based on the nameplate output power:

Nameplate Output (P_o)	Minimum Efficiency in Active Mode of Operation
< 1 W	$0.49 \times P_o$
≥ 1 W to ≤ 49 W	$0.09 \times \ln(P_o) + 0.5$ [ln = natural log]
> 49 W	0.84 W

For adapters that are single input voltage only, the measurement is made at the rated single nominal input voltage (115 VAC or 230 VAC); for universal input adapters the measurement is made at both nominal input voltages (115 VAC and 230 VAC).



To meet the standard, the measured average efficiency (or efficiencies for universal input supplies) must be greater than or equal to the efficiency specified by the CEC/Energy Star standard.

Percent of Full Load	Efficiency (%)	
	115 VAC	230 VAC
25	83.9	78.2
50	78.2	73.5
75	75.0	74.2
100	73.8	73.1
Average	77.7	74.8
CEC specified minimum average efficiency (%)	68.1	

More states within the USA and other countries are adopting this standard; for the latest up to date information please visit the PI Green Room:

<http://www.powerint.com/greenroom/regulations.htm>

9.2 No-load Input Power

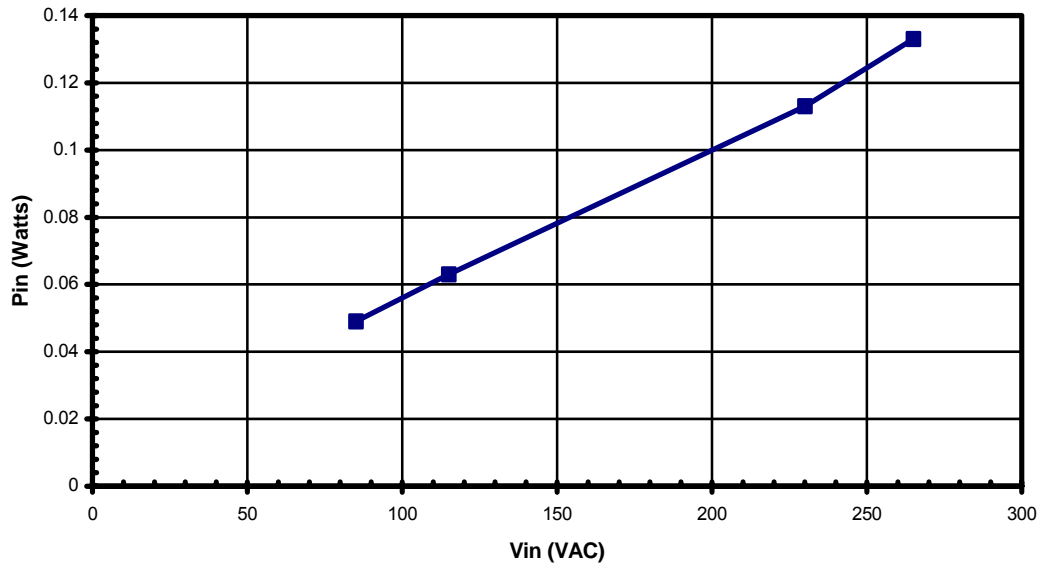

Figure 8 – Zero Load Input Power vs. Input Line Voltage, Room Temperature, 60 Hz.



9.3 Available Standby Output Power

The chart below shows the available output power vs line voltage for an input power of 1 W, 2 W and 3 W.

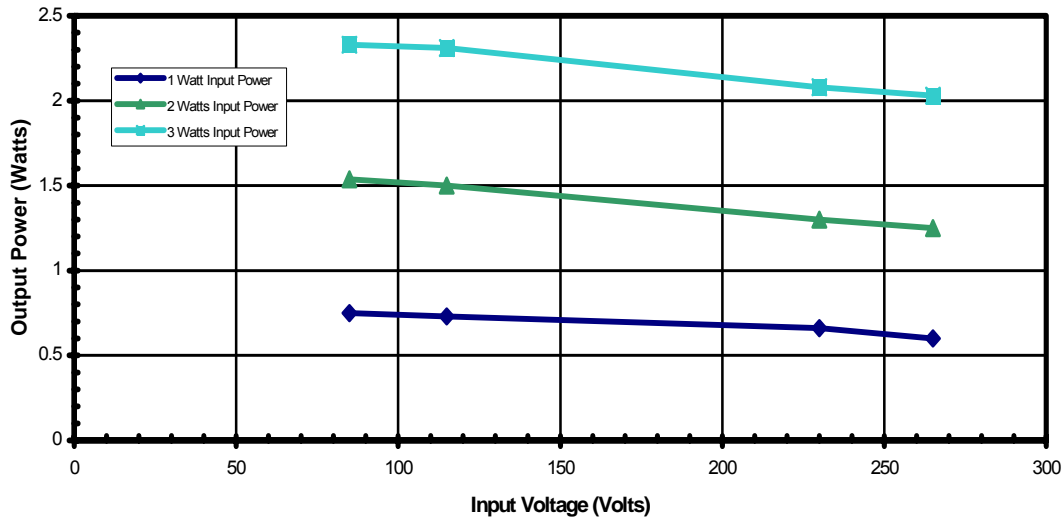

Figure 9 – Output Power vs. Line Voltage.



9.4 Regulation

9.4.1 Load Regulation, Room Temperature, 115 VAC input

These results represent the total variation as all outputs are swept from minimum to maximum load.

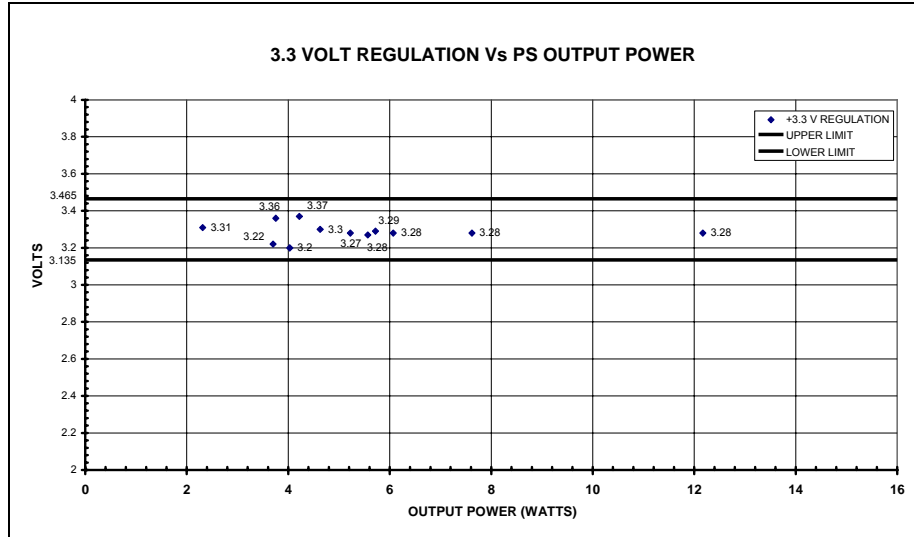

Figure 10 – 3.3 V Regulation vs. total output power.

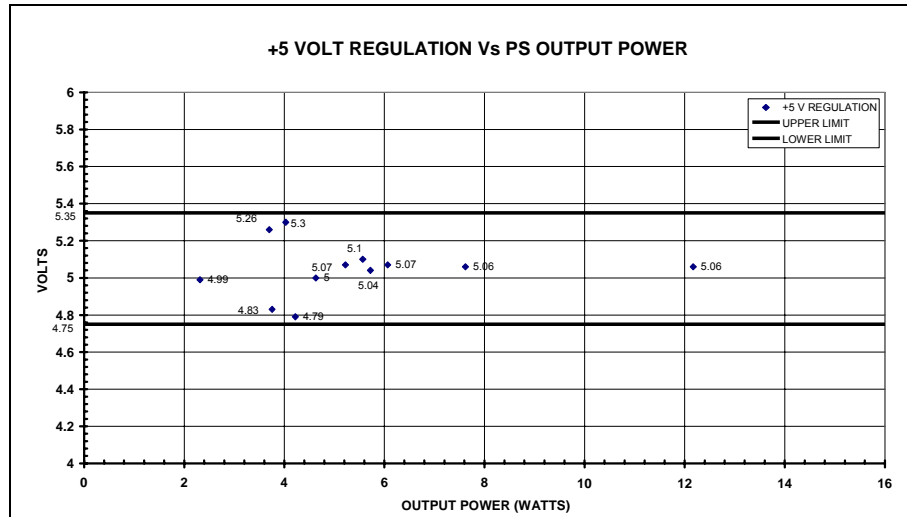

Figure 11 – 5.0 V Regulation vs. total output power.



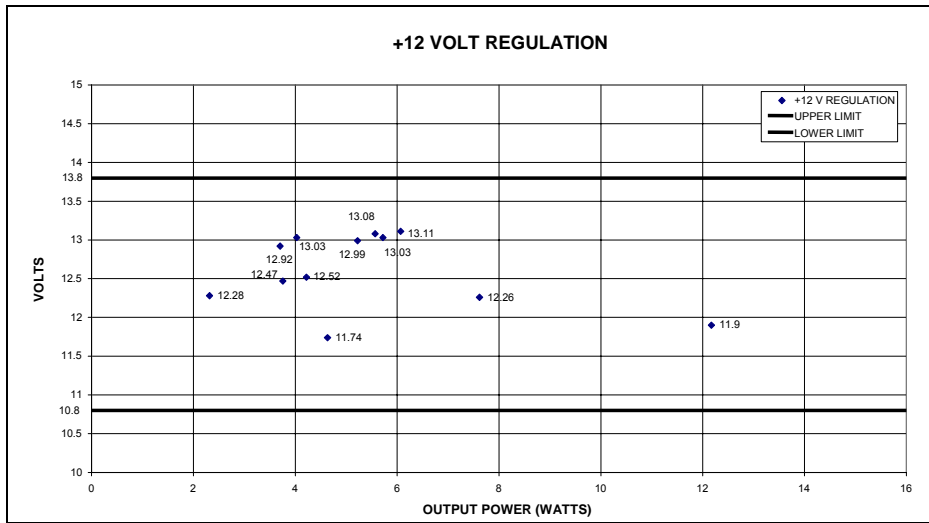

Figure 12 – +12 V Regulation vs. total output power.

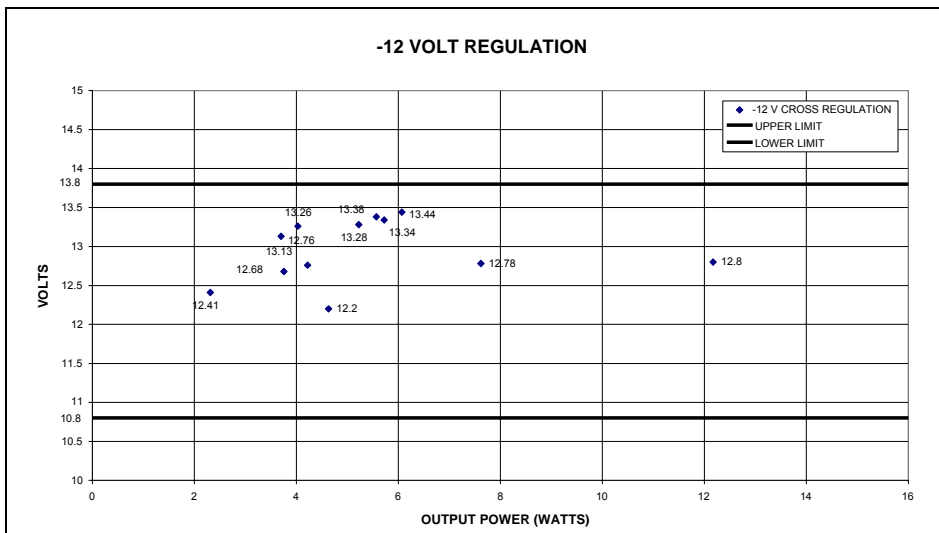

Figure 13 – -12 V Regulation vs. total output power.



9.4.2 Line

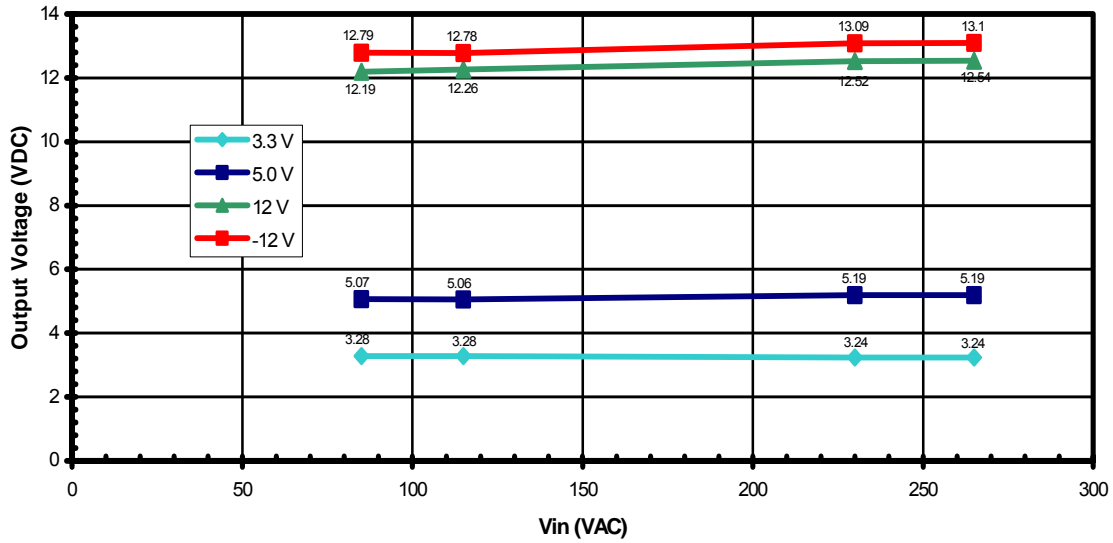

Figure 14 – Line Regulation, Room Temperature, Full Load.



10 Thermal Performance

Output was loaded to 7.51 W. RD-115 was housed in the intended enclosure, which was within a box inside the thermal test chamber (no air flow permitted). Ambient temperature was measured inside the enclosure. Test chamber temperature was set to 50 °C.

Item	Temperature (°C)		
	85 VAC	115 VAC	230 VAC
Ambient	54.5 °C	54 °C	56.2 °C
TNY376 (U4)	92 °C	92.6 °C	94.5 °C

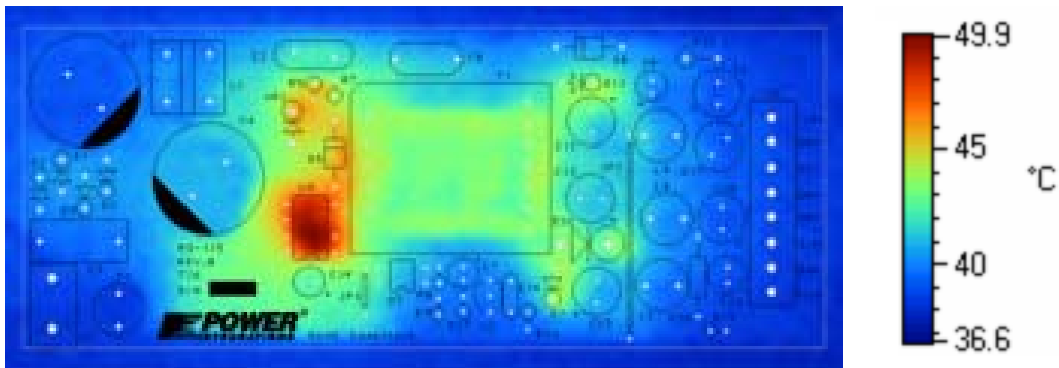

90 VAC, 7.5 W load, 21°C Ambient

Figure 15 – Infrared Thermograph of Open Frame Operation, at Room Temperature

11 Waveforms

11.1 Drain Voltage and Current, Normal Operation

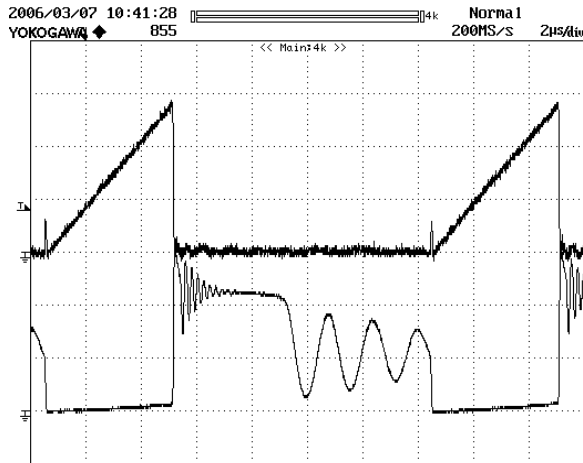

Figure 16 – 85 VAC, Full Load.
Upper: I_{DRAIN} , 0.2 A / div.
Lower: V_{DRAIN} , 100 V, 2 μ s / div.

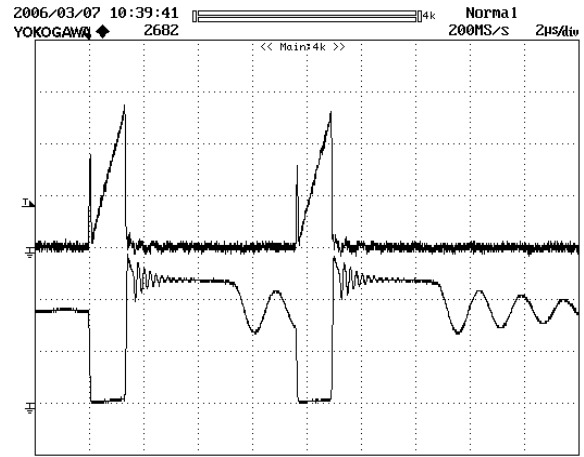

Figure 17 – 265 VAC, Full Load
Upper: I_{DRAIN} , 0.2 A / div.
Lower: V_{DRAIN} , 200 V / div.

11.2 Output Voltage Start-up Profile

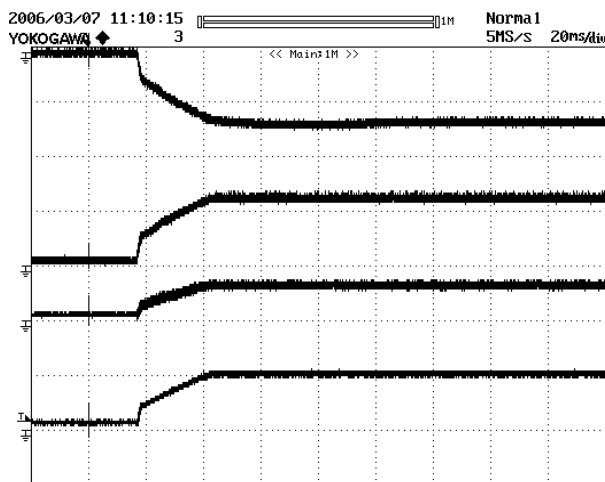

Figure 18 – Start-up Profile, 115 VAC.
Bottom Trace: 5 V Output at 5 V / div.
Next Trace: 3.3 V Output at 5 V / div.
Next Trace: +12 V Output at 10 V / div.
Top Trace: -12 V Output at 10 V / div.
20 ms / div.

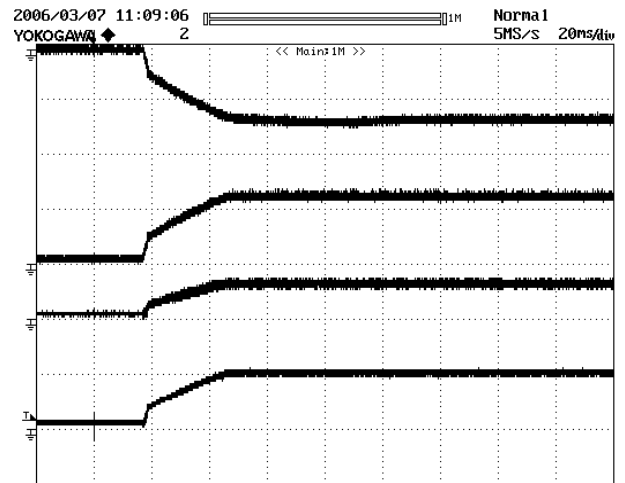

Figure 19 – Start-up Profile, 230 VAC.
Bottom Trace: 5 V Output at 5 V / div.
Next Trace: 3.3 V Output at 5 V / div.
Next Trace: +12 V Output at 10 V / div.
Top Trace: -12 V Output at 10 V / div.
20 ms / div



11.3 Drain Voltage and Current Start-up Profile

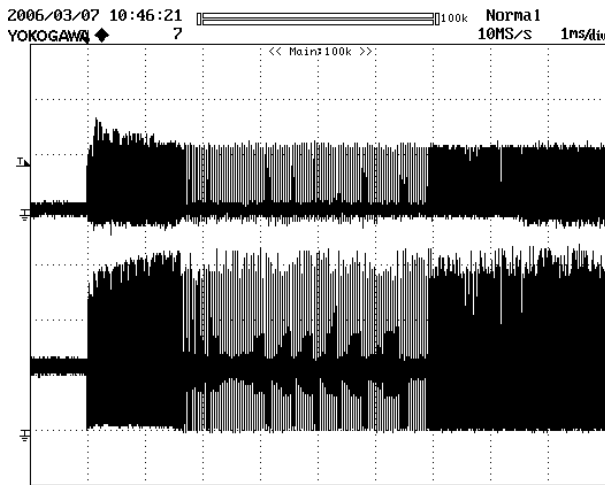

Figure 20 – 85 VAC Input and Maximum Load.
Upper: I_{DRAIN} , 0.5 A / div.
Lower: V_{DRAIN} , 100 V & 1 ms / div.

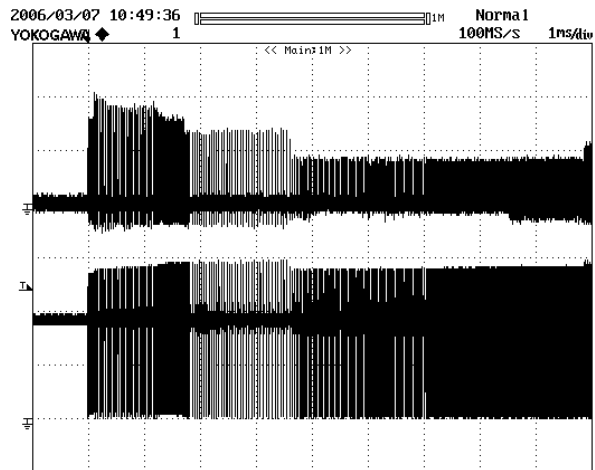

Figure 21 – 265 VAC Input and Maximum Load.
Upper: I_{DRAIN} , 0.5 A / div.
Lower: V_{DRAIN} , 200 V & 1 ms / div.

11.4 Load Transient Response

In the figures shown below, signal averaging was used to better enable viewing the load transient response. Since the output switching and line frequency occur essentially at random with respect to the load transient, contributions to the output ripple from these sources will average out, leaving the contribution only from the load step response.

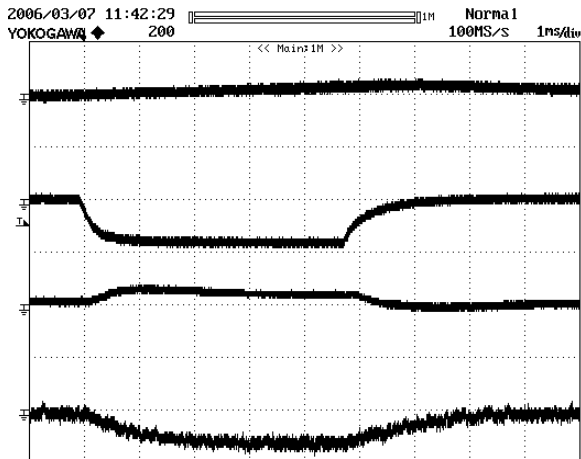

Figure 22 – Transient Response, 115 VAC, +12 V
0.25 A-0.64 A-0.25 A Load Step. All other outputs are at full load.
Bottom Trace: 5 V Output at 50 mV / div.
Next Trace: 3.3 V Output at 50 mV / div.
Next Trace: +12 V Output at 0.5 V / div.
Top Trace: -12 V Output at 0.5 V / div.
1 ms / div.

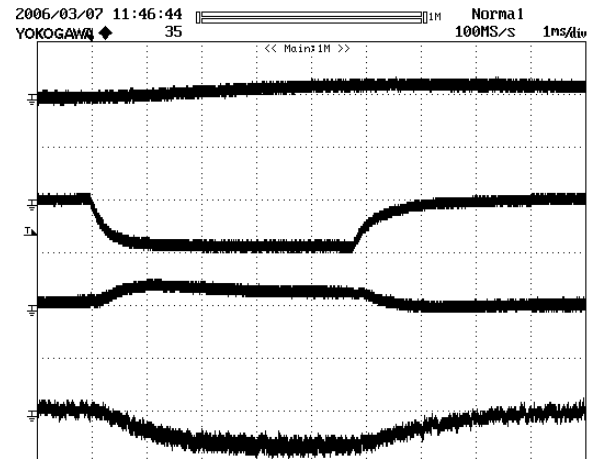

Figure 23 – Transient Response, 230 VAC, +12 V
0.25 A-0.64 A-0.25 A Load Step. All other outputs are at full load.
Bottom Trace: 5V Output at 50 mV / div.
Next Trace: 3.3V Output at 50 mV / div.
Next Trace: +12 V Output at 0.5 V / div.
Top Trace: -12 V Output at 0.5 V / div.
1 ms / div.



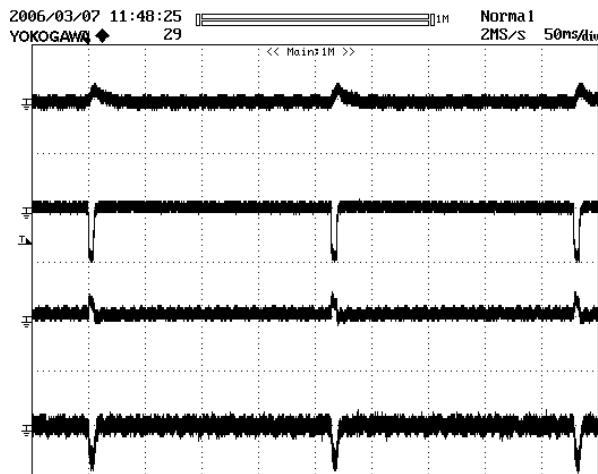

Figure 24– Transient Response, 230 VAC, +12 V
0.25 A-0.64 A-0.25 A Load Step. All
other outputs are at full load.
Bottom Trace: 5 V Output at 50 mV/div.
Next Trace: 3.3 V Output at 50 mV/div.
Next Trace: +12 V Output at 0.5 V/div.
Top Trace: -12 V Output at 0.5 V/div.
50 ms / div.

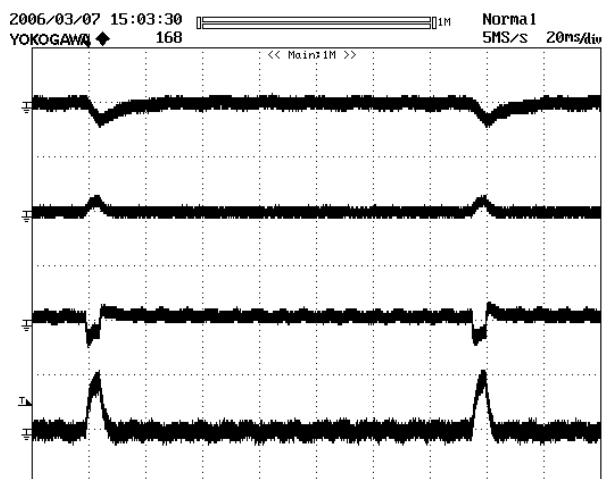

Figure 25 – Transient Response, 230 VAC, +3.3 V
0.375 A-0.5 A-0.375 A Load Step. All
other outputs are at full load.
Bottom Trace: 5 V Output at 50 mV / div.
Next Trace: 3.3 V Output at 50 mV / div.
Next Trace: +12 V Output at 0.5 V / div.
Top Trace: -12 V Output at 0.5 V / div.
20 ms / div.

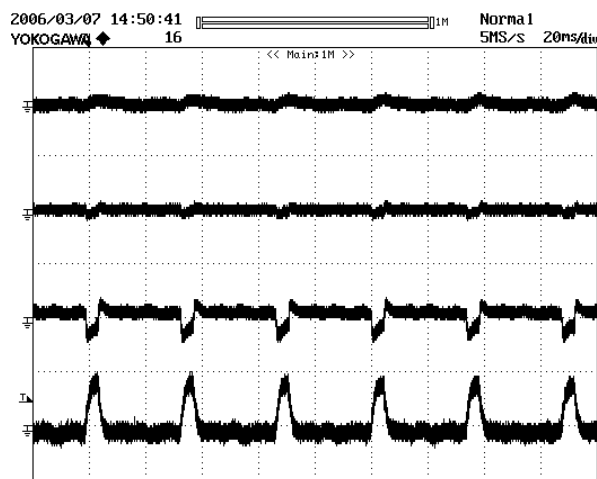

Figure 26 – Transient Response, 230 VAC, +5 V
0.375 A-0.5 A-0.375 A Load Step. All
other outputs are at full load.
Bottom Trace: 5 V Output at 50 mV / div.
Next Trace: 3.3 V Output at 50 mV / div.
Next Trace: +12 V Output at 0.5 V / div.
Top Trace: -12 V Output at 0.5 V / div.
20 ms / div.



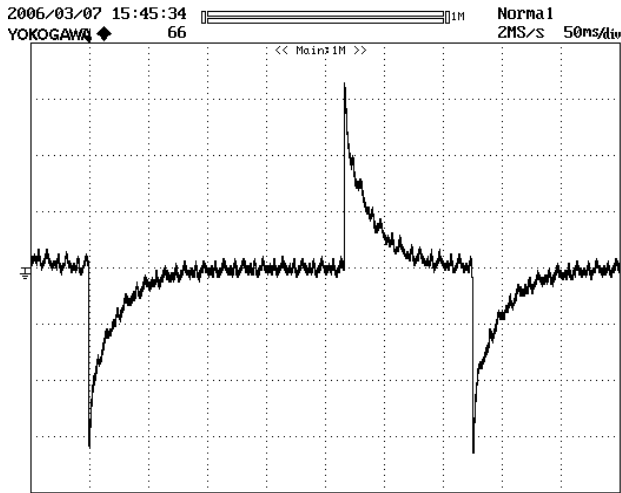

Figure 27 – Transient Response, 115 VAC, +3.3 V 0.375 A-0.6 A-0.375 A Load Step. All other outputs are at full load. 3.3 V Output at 10 mV / div. 50 ms / div.

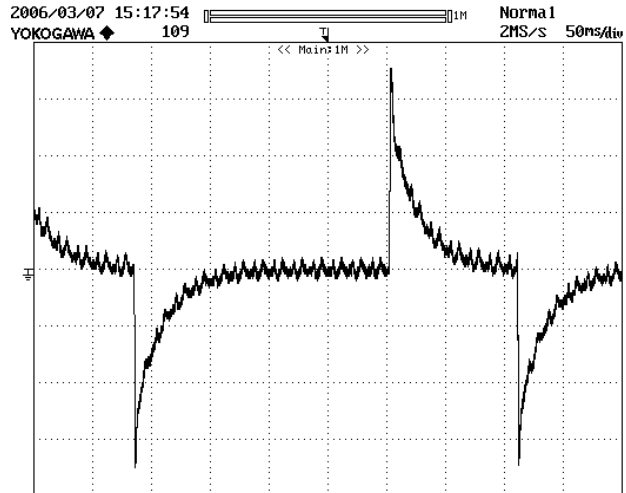

Figure 28 – Transient Response, 230 VAC, +3.3 V 0.375 A-0.6 A-0.375 A Load Step. All other outputs are at full load. 3.3 V Output at 10 mV / div. 50 ms / div.

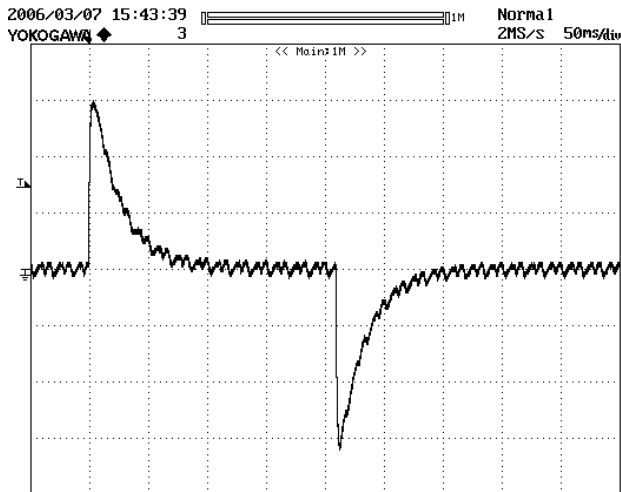

Figure 29 – Transient Response, 115 VAC, +5 V 0.375 A-0.6 A-0.375 A Load Step. All other outputs are at full load. 5 V Output at 20 mV / div. 50 ms / div.

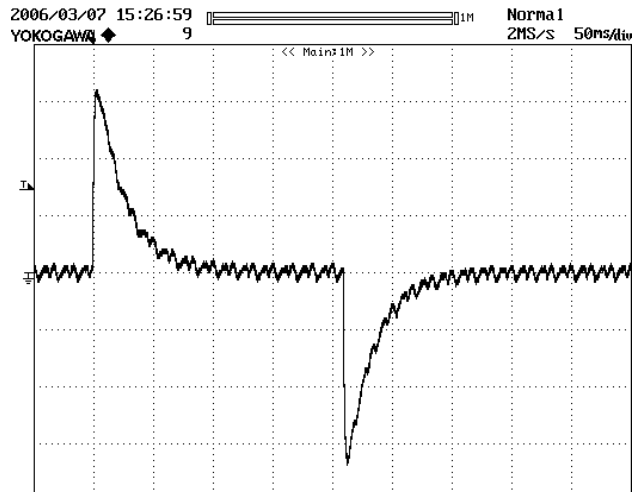

Figure 30 – Transient Response, 230 VAC, +5 V 0.375 A-0.6 A-0.375 A Load Step. All other outputs are at full load. 5 V Output at 20 mV / div. 50 ms / div.



11.5 Output Ripple Measurements

11.5.1 Ripple Measurement Technique

For DC output ripple measurements, a modified oscilloscope test probe must be utilized in order to reduce spurious signals due to pickup. Details of the probe modification are provided in Figure 31 and Figure 32.

The 5125BA probe adapter is affixed with two capacitors tied in parallel across the probe tip. The capacitors include one (1) 0.1 $\mu\text{F}/50\text{ V}$ ceramic type and one (1) 1.0 $\mu\text{F}/50\text{ V}$ aluminum electrolytic. **The aluminum electrolytic type capacitor is polarized, so proper polarity across DC outputs must be maintained (see below).**

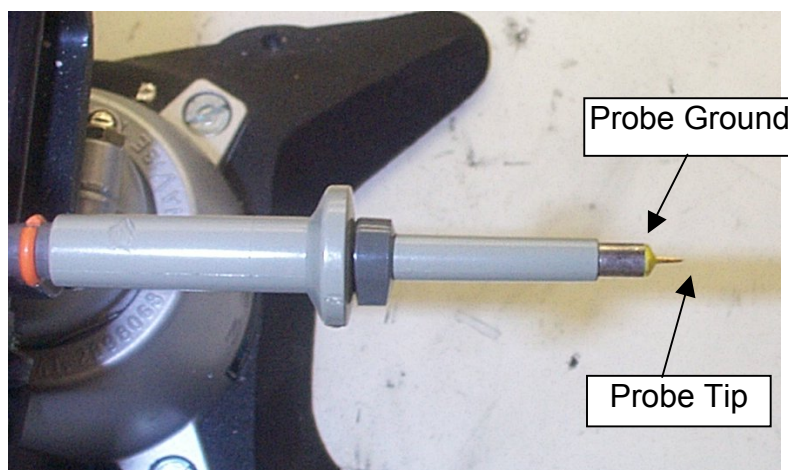

Figure 31 – Oscilloscope Probe Prepared for Ripple Measurement. (End Cap and Ground Lead Removed)



Figure 32 – Oscilloscope Probe with Probe Master 5125BA BNC Adapter. (Modified with wires for probe ground for ripple measurement, and two parallel decoupling capacitors added)

11.5.2 Measurement Results

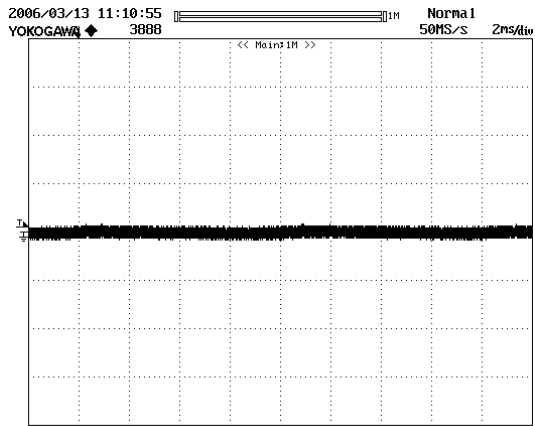

Figure 33 – 3.3 V Ripple, 115 VAC, Full Load.
2 ms, 50 mV / div.

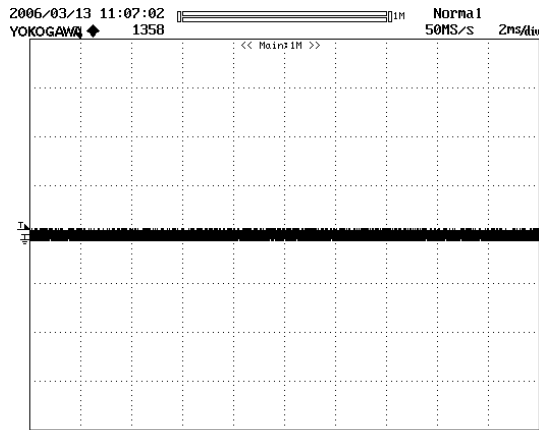

Figure 34 – 5 V Ripple, 115 VAC, Full Load.
2 ms, 50 mV / div.

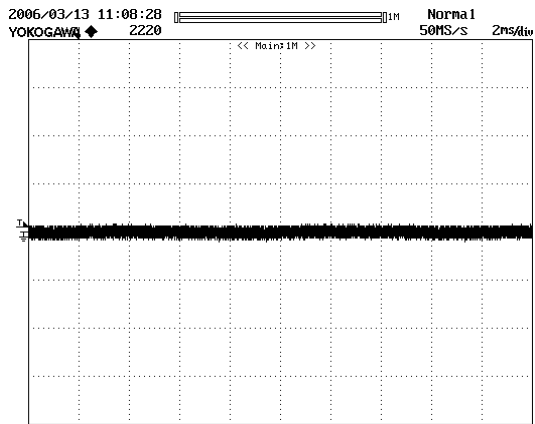

Figure 35 – +12V Ripple, 115 VAC, Full Load.
2 ms, 50 mV / div.

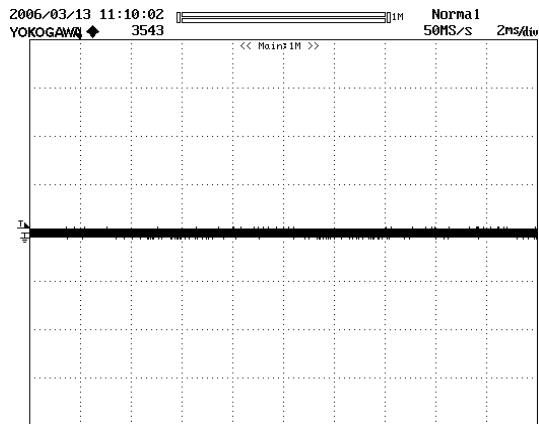

Figure 36 – -12 V Ripple, 115 VAC, Full Load.
2 ms, 50 mV /div.



11.6 Line Surge

Differential input line 1.2/50 μ s surge testing was completed on a single test unit to IEC61000-4-5. Input voltage was set at 230 VAC / 60 Hz. Output was loaded at full load and operation was verified following each surge event.

Surge Level (V)	Input Voltage (VAC)	Injection Location	Injection Phase (°)	Test Result (Pass/Fail)
+500	230	L to N	90	Pass
-500	230	L to N	90	Pass
+1000	230	L to N	90	Pass
-1000	230	L to N	90	Pass
+2000	230	L to N	90	Pass
-2000	230	L to N	90	Pass
+2000	230	L,N to G	90	Pass
-2000	230	L,N to G	90	Pass

Unit passes under all test conditions.



12 Conducted EMI

Conducted EMI was tested at 115 VAC as well as 230 VAC. In both cases the output was grounded.

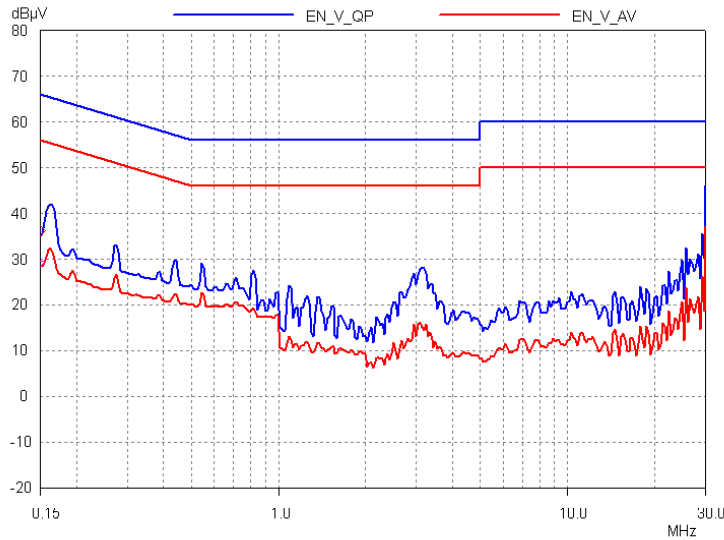

Figure 37 – Conducted EMI, Maximum Steady State Load, 115 VAC, 60 Hz, and EN55022 B Limits.

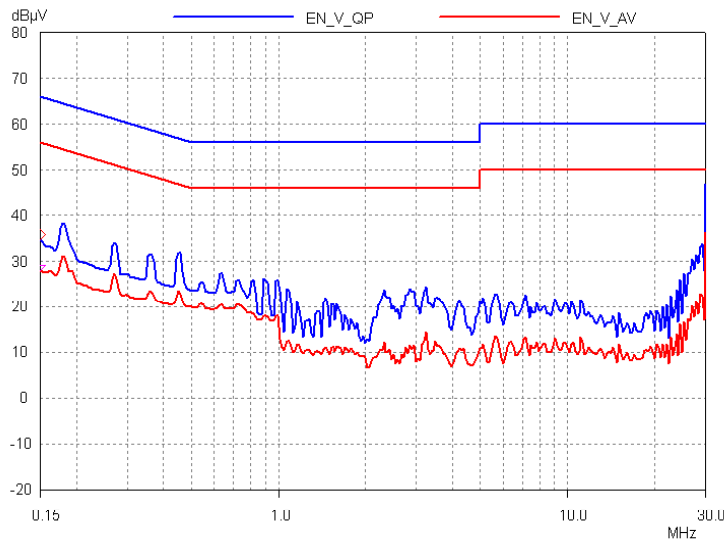

Figure 38 – Conducted EMI, Maximum Steady State Load, 230 VAC, 60 Hz, and EN55022 B Limits.



13 Appendix A

13.1 Output Power Delivery Using a TNY375PN

The table below compares the output power delivery of the TNY375PN vs. TNY376PN. No other modifications were made to the power supply. The measurements were taken at room temperature in open air. The input voltage was 85 VAC. The Continuous Power was measured when the source pin temperature stabilized at 71°C. This was the temperature that the TNY376 reached when delivering 7.5 Watts in the environment described above.

	TNY375PN	TNY376PN
Peak Power Capability (calculated)	11.4 W	13 W
Continuous Power Delivery (for 50 °C device temperature rise)	7.2 W	7.5 W



14 Revision History

Date	Author	Revision	Description & changes	Reviewed
22-May-07	SGK	1.0	Initial publication	



Notes



For the latest updates, visit our website: www.powerint.com

Power Integrations reserves the right to make changes to its products at any time to improve reliability or manufacturability. Power Integrations does not assume any liability arising from the use of any device or circuit described herein. POWER INTEGRATIONS MAKES NO WARRANTY HEREIN AND SPECIFICALLY DISCLAIMS ALL WARRANTIES INCLUDING, WITHOUT LIMITATION, THE IMPLIED WARRANTIES OF MERCHANTABILITY, FITNESS FOR A PARTICULAR PURPOSE, AND NON-INFRINGEMENT OF THIRD PARTY RIGHTS.

PATENT INFORMATION

The products and applications illustrated herein (including transformer construction and circuits external to the products) may be covered by one or more U.S. and foreign patents, or potentially by pending U.S. and foreign patent applications assigned to Power Integrations. A complete list of Power Integrations' patents may be found at www.powerint.com. Power Integrations grants its customers a license under certain patent rights as set forth at <http://www.powerint.com/ip.htm>.

The PI Logo, **TOPSwitch**, **TinySwitch**, **LinkSwitch**, **DPA-Switch**, **PeakSwitch**, **EcoSmart**, **Clampless**, **E-Shield**, **Filterfuse**, **StackFET**, **PI Expert** and **PI FACTS** are trademarks of Power Integrations, Inc. Other trademarks are property of their respective companies. ©Copyright 2007 Power Integrations, Inc.

Power Integrations Worldwide Sales Support Locations

WORLD HEADQUARTERS

5245 Hellyer Avenue
San Jose, CA 95138, USA.
Main: +1-408-414-9200
Customer Service:
Phone: +1-408-414-9665
Fax: +1-408-414-9765
e-mail: usasales@powerint.com

GERMANY

Rueckertstrasse 3
D-80336, Munich
Germany
Phone: +49-89-5527-3910
Fax: +49-89-5527-3920
e-mail: eurosales@powerint.com

JAPAN

1st Bldg Shin-Yokohama
2-12-20 Kohoku-ku,
Yokohama-shi, Kanagawa
ken, Japan 222-0033
Phone: +81-45-471-1021
Fax: +81-45-471-3717
e-mail: japansales@powerint.com

TAIWAN

5F, No. 318, Nei Hu Rd., Sec. 1
Nei Hu Dist.
Taipei, Taiwan 114, R.O.C.
Phone: +886-2-2659-4570
Fax: +886-2-2659-4550
e-mail: taiwansales@powerint.com

CHINA (SHANGHAI)

Rm 807-808A,
Pacheer Commercial Centre,
555 Nanjing Rd. West
Shanghai, P.R.C. 200041
Phone: +86-21-6215-5548
Fax: +86-21-6215-2468
e-mail: chinasales@powerint.com

INDIA

#1, 14th Main Road
Vasanthanagar
Bangalore-560052 India
Phone: +91-80-41138020
Fax: +91-80-41138023
e-mail: indiasales@powerint.com

KOREA

RM 602, 6FL
Korea City Air Terminal B/D,
159-6
Samsung-Dong, Kangnam-Gu,
Seoul, 135-728, Korea
Phone: +82-2-2016-6610
Fax: +82-2-2016-6630
e-mail: koreasales@powerint.com

UNITED KINGDOM

1st Floor, St. James's House
East Street, Farnham
Surrey, GU9 7TJ
United Kingdom
Phone: +44 (0) 1252-730-140
Fax: +44 (0) 1252-727-689
e-mail: eurosales@powerint.com

CHINA (SHENZHEN)

Room 2206-2207, Block A,
Elec. Sci. Tech. Bldg.
2070 Shennan Zhong Rd.
Shenzhen, Guangdong,
China, 518031
Phone: +86-755-8379-3243
Fax: +86-755-8379-5828
e-mail: chinasales@powerint.com

ITALY

Via De Amicis 2
20091 Bresso MI – Italy
Phone: +39-028-928-6000
Fax: +39-028-928-6009
e-mail: eurosales@powerint.com

SINGAPORE

51 Newton Road,
#15-08/10 Goldhill Plaza,
Singapore, 308900
Phone: +65-6358-2160
Fax: +65-6358-2015
e-mail: singaporesales@powerint.com

APPLICATIONS HOTLINE

World Wide +1-408-414-9660

APPLICATIONS FAX

World Wide +1-408-414-9760



Power Integrations

Tel: +1 408 414 9200 Fax: +1 408 414 9201
www.powerint.com