

DS36276 FAILSAFE Multipoint Transceiver

General Description

The DS36276 FAILSAFE Multipoint Transceiver is designed for use on bi-directional differential busses. It is compatible with existing TIA/EIA-485 transceivers, however, it offers an additional feature not supported by standard transceivers.

The FAILSAFE feature guarantees the receiver output to a known state when the Interface is in the following conditions: Floating Line, Idle Line (no active drivers), and Line Fault conditions (open or short). The receiver output is in a HIGH state for the following conditions: OPEN Inputs, Terminated Inputs (50Ω), and SHORTED Inputs.

FAILSAFE is a highly desirable feature when the transceivers are used with Asynchronous Controllers such as UARTs.

Features

- FAILSAFE receiver, RO = HIGH for:
 - OPEN inputs
 - Terminated inputs
 - SHORTED inputs
- Compatible with popular interface standards:
 - TIA/EIA-485 (RS-485)
 - TIA/EIA-422-A (RS-422-A)
 - CCITT Recommendation V.11
- Bi-Directional Transceiver
 - Designed for multipoint transmission
- Separate driver input, driver enable, receiver enable, and receiver output for maximum flexibility
- Wide bus common mode range
 - (-7V to +12V)
- Pin compatible with: DS75176B, DS96176, DS3695 and SN75176A and B
- Available in SOIC package

Connection and Logic Diagram

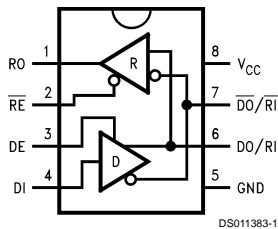

DS011383-1
Order Number DS36276M
See NS Package Number M08A

Truth Tables

Driver

Inputs			Outputs	
\overline{RE}	DE	DI	DO/RI	$\overline{DO/RI}$
X	H	H	H	L
X	H	L	L	H
X	L	X	Z	Z

Receiver

Inputs			Output
\overline{RE}	DE	RI- \overline{RI}	RO
L	L	$\geq 0V$	H
L	L	$\leq -500\text{ mV}$	L
H	X	X	Z

Receiver FAILSAFE

Inputs			Output
\overline{RE}	DE	RI- \overline{RI}	RO
L	L	SHORTED	H
L	L	OPEN	H
H	X	X	Z

Absolute Maximum Ratings (Note 1)

If Military/Aerospace specified devices are required, please contact the National Semiconductor Sales Office/Distributors for availability and specifications.

Supply Voltage (V_{CC})	7V
Input Voltage (DE, \overline{RE} , and DI)	5.5V
Driver Output Voltage/Receiver Input Voltage	-10V to +15V
Receiver Output Voltage (RO)	5.5V
Maximum Package Power Dissipation @ +25°C	
M Package (derate 5.8 mW/°C above +25°C)	726 mW
Storage Temperature Range	-65°C to +150°C

Lead Temperature (Soldering 4 sec.)	260°C
Max Junction Temperature	150°C
ESD Rating (HBM, 1.5 kΩ, 100 pF)	≥ 6.0 kV

Recommended Operating Conditions

	Min	Max	Units
Supply Voltage, V_{CC}	4.75	5.25	V
Bus Voltage	-7	+12	V
Operating Temperature (T_A) DS36276	0	+70	°C

Electrical Characteristics (Notes 2, 4)

Over recommended Supply Voltage and Operating Temperature ranges, unless otherwise specified.

Symbol	Parameter	Conditions	Min	Typ	Max	Units		
DRIVER CHARACTERISTICS								
V_{OD}	Differential Output Voltage	$I_O = 0$ mA (No Load)	1.5	4.8	6.0	V		
V_{ODO}	Output Voltage	$I_O = 0$ mA (Output to GND)	0		6.0	V		
$V_{\overline{ODO}}$	Output Voltage		0		6.0	V		
V_{T1}	Differential Output Voltage (Termination Load)	$R_L = 54\Omega$ (485)	(Figure 1)		1.5	2.0	5.0	V
		$R_L = 100\Omega$ (422)	2.0	2.3	5.0	V		
ΔV_{T1}	Balance of V_{T1} $ V_{T1} - \overline{V_{T1}} $	$R_L = 54\Omega$	(Note 3)		-0.2	0.07	+0.2	V
		$R_L = 100\Omega$	-0.2	0.07	+0.2	V		
V_{OS}	Driver Common Mode Output Voltage	$R_L = 54\Omega$	(Figure 1)		0	2.5	3.0	V
		$R_L = 100\Omega$	0	2.3	3.0	V		
ΔV_{OS}	Balance of V_{OS} $ V_{OS} - \overline{V_{OS}} $	$R_L = 54\Omega$	(Note 3)		-0.2	0.08	+0.2	V
		$R_L = 100\Omega$	-0.2	0.08	+0.2	V		
I_{OSD}	Driver Short-Circuit Output Current	$V_O = +12V$	(Figure 3)			134	290	mA
		$V_O = V_{CC}$		140		mA		
		$V_O = 0V$		-140		mA		
		$V_O = -7V$		-180	-290	mA		
RECEIVER CHARACTERISTICS								
V_{TH}	Differential Input High Threshold Voltage (Note 5)	$V_O = V_{OH}$, $I_O = -0.4$ mA $-7V \leq V_{CM} \leq +12V$		-0.18	0	V		
V_{TL}	Differential Input Low Threshold Voltage (Note 5)	$V_O = V_{OL}$, $I_O = 8.0$ mA $-7V \leq V_{CM} \leq +12V$	-0.5	-0.23		V		
V_{HST}	Hysteresis (Note 6)	$V_{CM} = 0V$		50		mV		
I_{IN}	Line Input Current ($V_{CC} = 4.75V, 5.25V, 0V$)	Other Input = 0V	$V_I = +12V$		0.7	1.0	mA	
		DE = V_{IH} (Note 7)	$V_I = -7V$		-0.5	-0.8	mA	
I_{OSR}	Short Circuit Current	$V_O = 0V$	RO	-5.0	-30	-85	mA	
I_{OZ}	TRI-STATE® Leakage Current	$V_O = 0.4$ to 2.4V		-20		+20	μA	
V_{OH}	Output High Voltage (Figure 12)	$V_{ID} = 0V$, $I_{OH} = -0.4$ mA		2.5	3.5		V	
		$V_{ID} = OPEN$, $I_{OH} = -0.4$ mA		2.5	3.5		V	
V_{OL}	Output Low Voltage (Figure 12)	$V_{ID} = -0.5V$, $I_{OL} = +8$ mA		0.25	0.6	V		
		$V_{ID} = -0.5V$, $I_{OL} = +16$ mA		0.35	0.7	V		
R_{IN}	Input Resistance		12	19		kΩ		

Electrical Characteristics (Notes 2, 4) (Continued)

Over recommended Supply Voltage and Operating Temperature ranges, unless otherwise specified.

Symbol	Parameter	Conditions	Min	Typ	Max	Units
DEVICE CHARACTERISTICS						
V_{IH}	High Level Input Voltage		DE, RE, or DI	2.0	V_{CC}	V
V_{IL}	Low Level Input Voltage			GND	0.8	V
I_{IH}	High Level Input Current	$V_{IH} = 2.4V$			20	μA
I_{IL}	Low Level Input Current	$V_{IL} = 0.4V$			-100	μA
V_{CL}	Input Clamp Voltage	$I_{CL} = -18 mA$		-0.75	-1.5	V
I_{CC}	Output Low Voltage	DE = 3V, RE = 0V, DI = 0V		42	60	mA
I_{CCR}	Supply Current (No Load)	DE = 0V, RE = 0V, DI = 0V		28	45	mA
I_{CCD}		DE = 3V, RE = 3V, DI = 0V		43	60	mA
I_{CCX}		DE = 0V, RE = 3V, DI = 0V		31	50	mA

Switching Characteristics (Note 4)

Over recommended Supply Voltage and Operating Temperature ranges, unless otherwise specified.

Symbol	Parameter	Conditions	Min	Typ	Max	Units
DRIVER CHARACTERISTICS						
t_{PLHD}	Diff. Prop. Delay Low to High	$R_L = 54\Omega$ $C_L = 50 pF$ $C_D = 50 pF$ (Figures 4, 5)	7	21	60	ns
t_{PHLD}	Diff. Prop. Delay High to Low		7	19	60	ns
t_{SKD}	Diff. Skew ($ t_{PLHD} - t_{PHLD} $)			2	10	ns
t_r	Diff. Rise Time			12	50	ns
t_f	Diff. Fall Time			12	50	ns
t_{PLH}	Prop. Delay Low to High	$R_L = 27\Omega$, $C_L = 15 pF$ (Figures 6, 7)		22	45	ns
t_{PHL}	Prop. Delay High to Low			22	45	ns
t_{PZH}	Enable Time Z to High	$R_L = 110\Omega$ $C_L = 50 pF$ (Figure 8 - Figure 11)		32	55	ns
t_{PZL}	Enable Time Z to Low			32	65	ns
t_{PHZ}	Disable Time High to Z			22	55	ns
t_{PLZ}	Disable Time Low to Z			16	55	ns
RECEIVER CHARACTERISTICS						
t_{PLH}	Prop. Delay Low to High	$V_{ID} = -1.5V$ to $+1.5V$ $C_L = 15 pF$ (Figures 13, 14)	15	40	70	ns
t_{PHL}	Prop. Delay High to Low		15	42	70	ns
t_{SK}	Skew ($ t_{PLH} - t_{PHL} $)			2	15	ns
t_{PZH}	Enable Time Z to High	$C_L = 15 pF$ (Figures 15, 16)		15	50	ns
t_{PZL}	Enable Time Z to Low			17	50	ns
t_{PHZ}	Disable Time High to Z			24	50	ns
t_{PLZ}	Disable Time Low to Z			19	50	ns

Note 1: "Absolute Maximum Ratings" are those values beyond which the safety of the device cannot be guaranteed. They are not meant to imply that the devices should be operated at these limits. The tables of "Electrical Characteristics" specify conditions for device operation.

Note 2: Current into device pins is defined as positive. Current out of device pins is defined as negative. All voltages are referenced to ground unless otherwise specified.

Note 3: $\Delta |V_{T1}|$ and $\Delta |V_{OS}|$ are changes in magnitude of V_{T1} and V_{OS} , respectively, that occur when the input changes state.

Note 4: All typicals are given for $V_{CC} = 5.0V$ and $T_A = +25^\circ C$.

Note 5: Threshold parameter limits specified as an algebraic value rather than by magnitude.

Note 6: Hysteresis defined as $V_{HST} = V_{TH} - V_{TL}$.

Note 7: I_{IN} includes the receiver input current and driver TRI-STATE leakage current.

Parameter Measurement Information

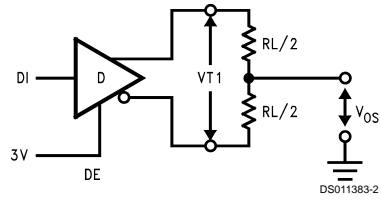

FIGURE 1. Driver V_{T1} and V_{OS} Test Circuit

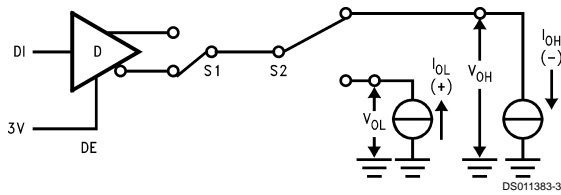

FIGURE 2. Driver V_{OH} and V_{OL} Test Circuit

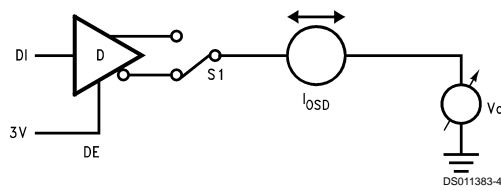

FIGURE 3. Driver Short Circuit Test Circuit

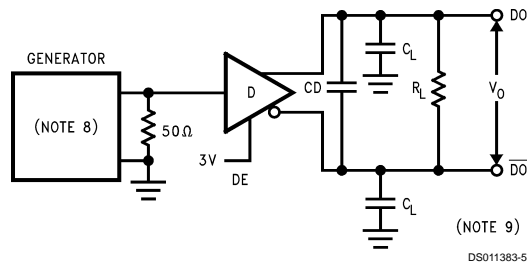

FIGURE 4. Driver Differential Propagation Delay and Transition Time Test Circuit

Parameter Measurement Information (Continued)

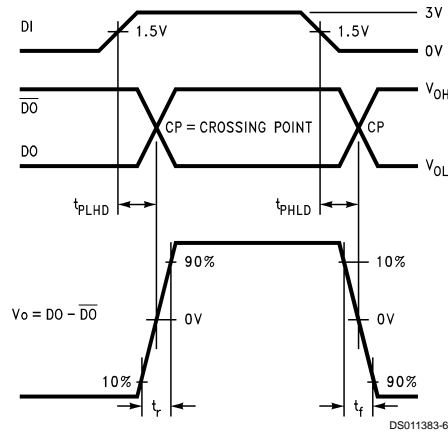

FIGURE 5. Driver Differential Propagation Delays and Transition Times

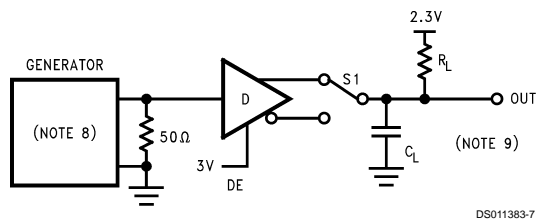

FIGURE 6. Driver Propagation Delay Test Circuit

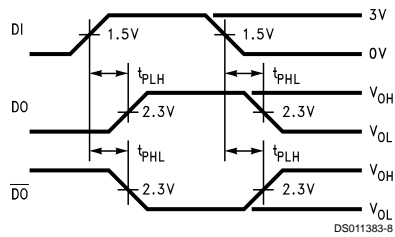
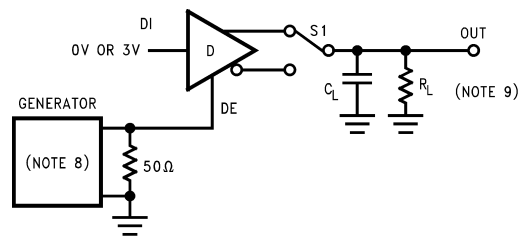

FIGURE 7. Driver Propagation Delays



S1 to DO for DI = 3V
S1 to DO-bar for DI = 0V

FIGURE 8. Driver TRI-STATE Test Circuit (t_{PZH} , t_{PHZ})

Parameter Measurement Information (Continued)

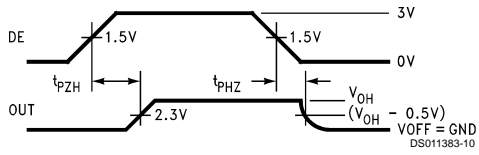
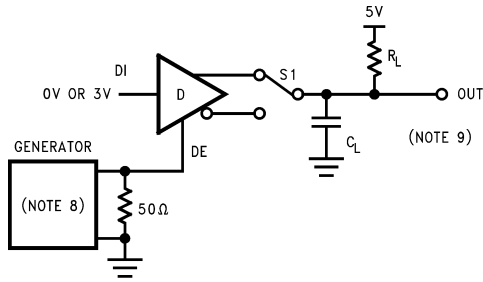

FIGURE 9. Driver TRI-STATE Delays (t_{PZH} , t_{PHZ})



S1 to \overline{DO} for DI = 0V
S1 to \overline{DO} for DI = 3V

FIGURE 10. Driver TRI-STATE Test Circuit (t_{PZL} , t_{PLZ})

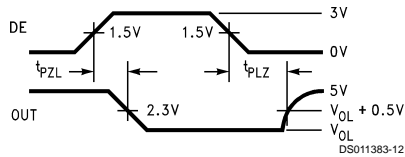

FIGURE 11. Driver TRI-STATE Delays (t_{PZL} , t_{PLZ})

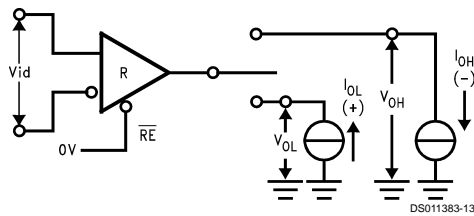

FIGURE 12. Receiver V_{OH} and V_{OL}

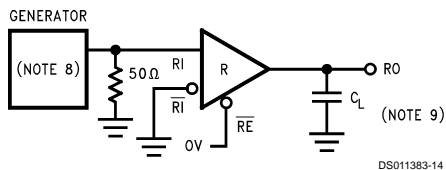

FIGURE 13. Receiver Propagation Delay Test Circuit

Parameter Measurement Information (Continued)

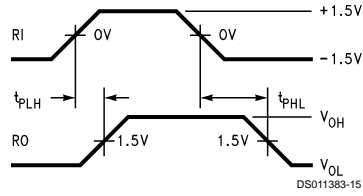

FIGURE 14. Receiver Propagation Delays

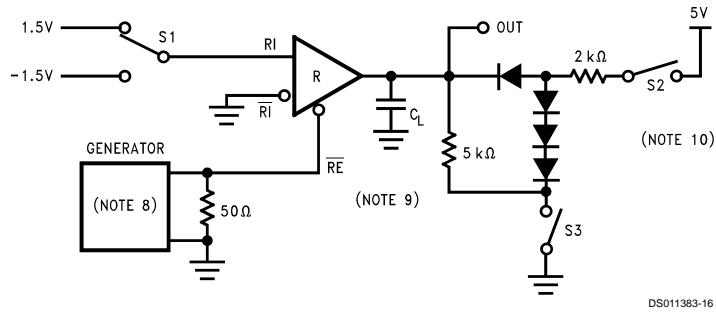
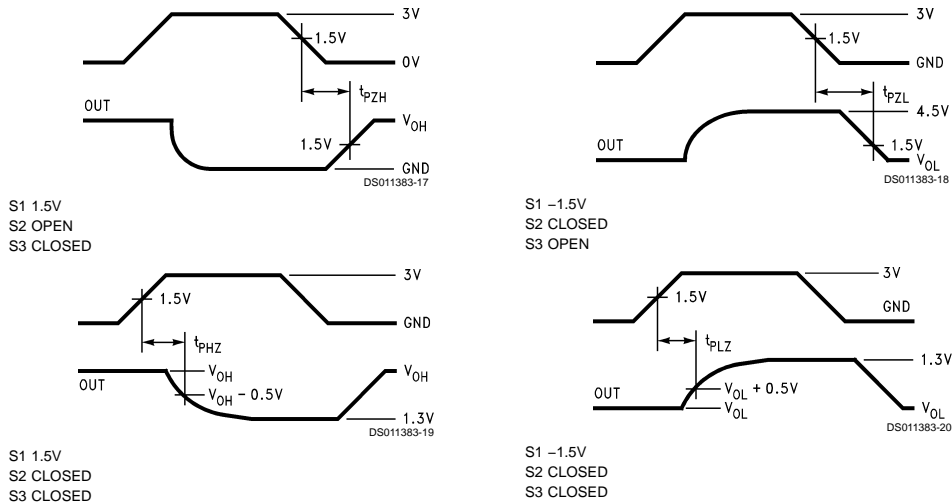

FIGURE 15. Receiver TRI-STATE Delay Test Circuit



Note 8: The input pulse is supplied by a generator having the following characteristics: $f = 1.0$ MHz, 50% duty cycle, t_r and $t_f < 6.0$ ns, $Z_0 = 50\Omega$.

Note 9: C_L includes probe and stray capacitance.

Note 10: Diodes are 1N916 or equivalent.

FIGURE 16. Receiver Enable and Disable Timing

Typical Performance Characteristics

Differential Output Voltage vs Output Current

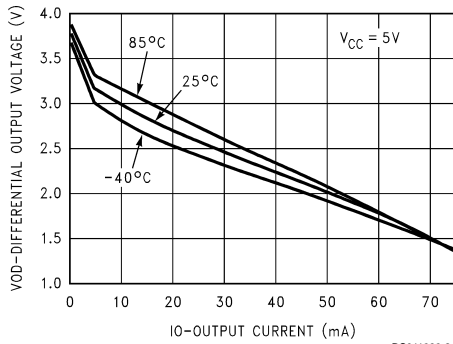

DS011383-21

Differential Output Voltage vs Output Current

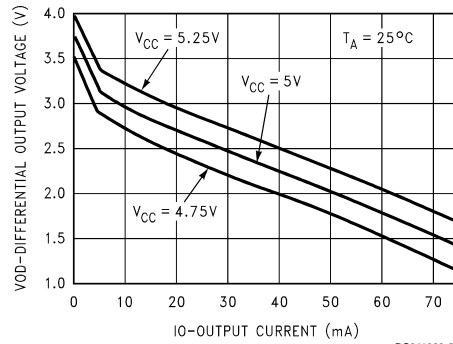

DS011383-22

Driver V_{OH} vs I_{OH} vs V_{CC}

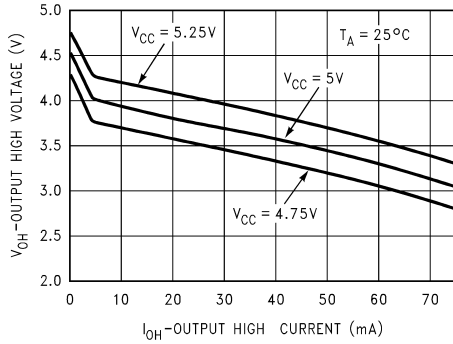

DS011383-23

Driver V_{OH} vs I_{OH} vs Temperature

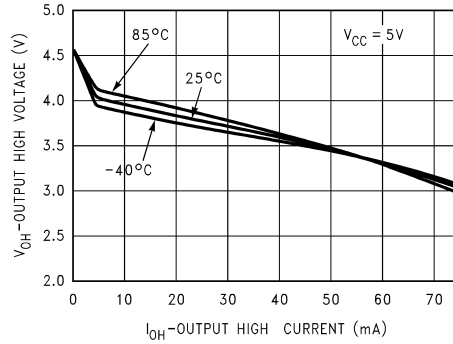

DS011383-24

Driver V_{OL} vs I_{OL} vs V_{CC}

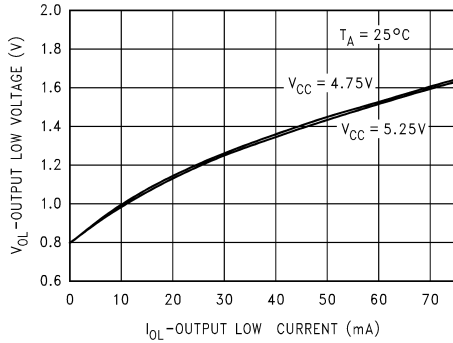

DS011383-25

Driver V_{OL} vs I_{OL} vs Temperature

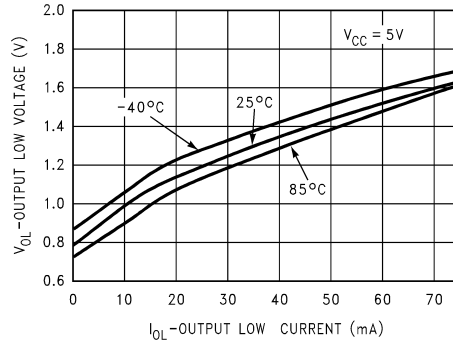

DS011383-26

Typical Performance Characteristics (Continued)

Receiver V_{OH} vs I_{OH} vs V_{CC}

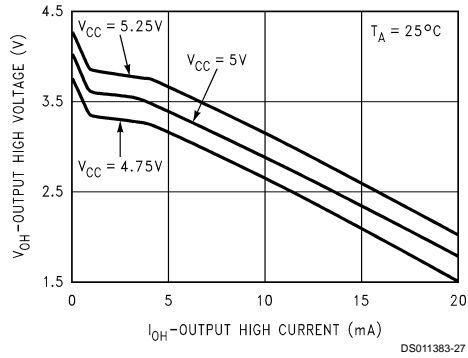

Receiver V_{OH} vs I_{OH} vs Temperature

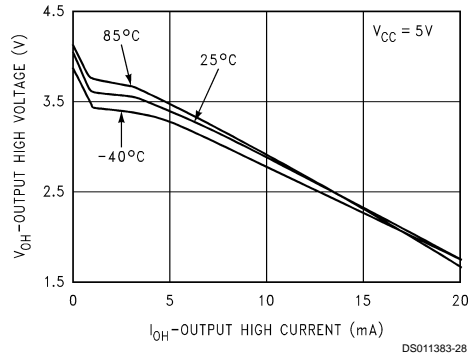

Receiver V_{OL} vs I_{OL} vs V_{CC}

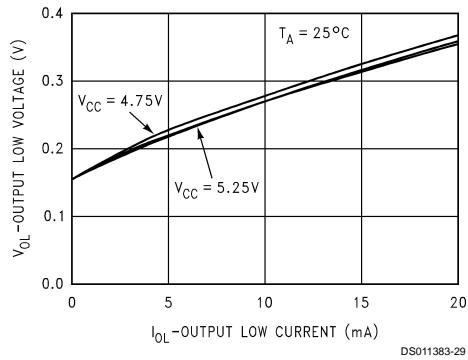

Receiver V_{OL} vs I_{OL} vs Temperature

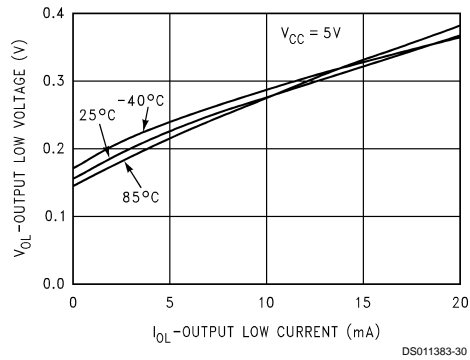

Supply Current vs Supply Voltage

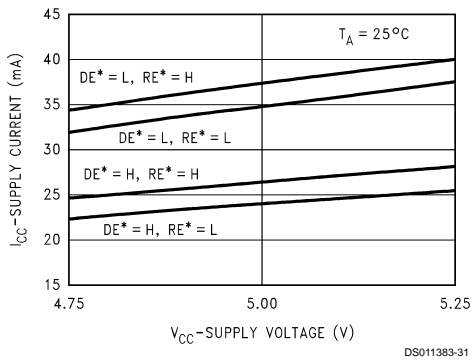

Supply Current vs Temperature

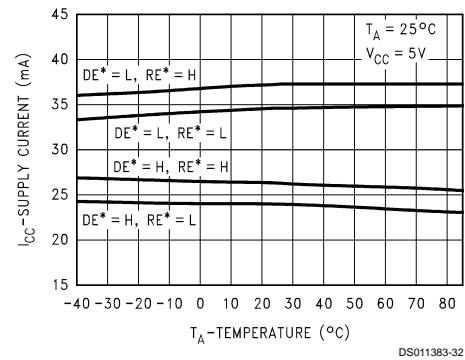

Typical Performance Characteristics (Continued)

Voltage Output vs Voltage Input (Hysteresis)

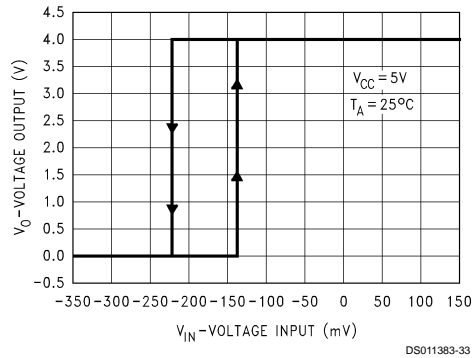



Physical Dimensions inches (millimeters) unless otherwise noted

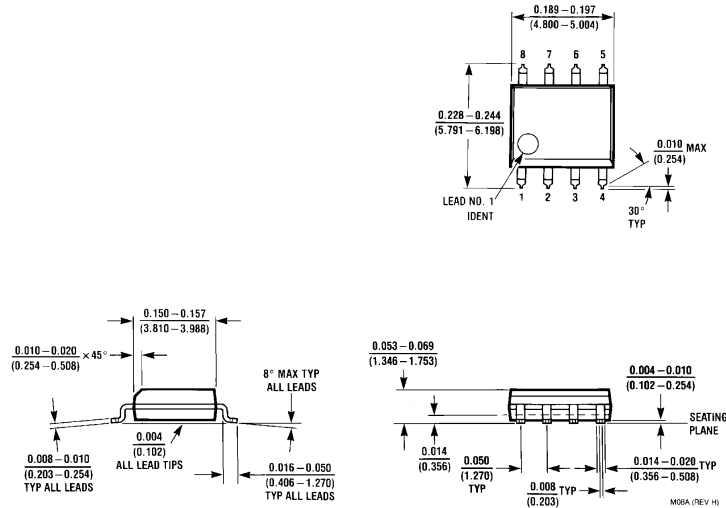

Order Number DS36276M
NS Package Number M08A

LIFE SUPPORT POLICY

NATIONAL'S PRODUCTS ARE NOT AUTHORIZED FOR USE AS CRITICAL COMPONENTS IN LIFE SUPPORT DEVICES OR SYSTEMS WITHOUT THE EXPRESS WRITTEN APPROVAL OF THE PRESIDENT OF NATIONAL SEMICONDUCTOR CORPORATION. As used herein:

1. Life support devices or systems are devices or systems which, (a) are intended for surgical implant into the body, or (b) support or sustain life, and whose failure to perform when properly used in accordance with instructions for use provided in the labeling, can be reasonably expected to result in a significant injury to the user.
2. A critical component is any component of a life support device or system whose failure to perform can be reasonably expected to cause the failure of the life support device or system, or to affect its safety or effectiveness.

 **National Semiconductor Corporation**
Americas
Tel: 1-800-272-9959
Fax: 1-800-737-7018
Email: support@nsc.com

National Semiconductor Europe
Fax: +49 (0) 1 80-530 85 86
Email: europe.support@nsc.com
Deutsch Tel: +49 (0) 1 80-530 85 85
English Tel: +49 (0) 1 80-532 78 32
Français Tel: +49 (0) 1 80-532 93 58
Italiano Tel: +49 (0) 1 80-534 16 80

National Semiconductor Asia Pacific Customer Response Group
Tel: 65-2544466
Fax: 65-2504466
Email: sea.support@nsc.com

National Semiconductor Japan Ltd.
Tel: 81-3-5639-7560
Fax: 81-3-5639-7507

www.national.com