

2-Mbit (128K x 16) Static RAM

Features

- **Very high speed: 45 ns**
- **Wide voltage range: 2.20V–3.60V**
- **Pin-compatible with CY62136CV30**
- **Ultra low standby power**
 - **Typical standby current: 1μA**
 - **Maximum standby current: 7μA**
- **Ultra-low active power**
 - **Typical active current: 2 mA @ f = 1 MHz**
- **Easy memory expansion with \overline{CE} , and \overline{OE} features**
- **Automatic power-down when deselected**
- **CMOS for optimum speed/power**
- **Offered in a Pb-free 48-ball VFBGA and 44-pin TSOP II packages**

Functional Description^[1]

The CY62136EV30 is a high-performance CMOS static RAM organized as 128K words by 16 bits. This device features advanced circuit design to provide ultra-low active current. This is ideal for providing More Battery Life™ (MoBL®) in portable applications such as cellular telephones. The device also has an automatic power-down feature that significantly reduces power consumption by 80% when addresses are not toggling. The device can also be put into standby mode reducing power consumption by more than 99% when deselected (\overline{CE} HIGH). The input/output pins (I/O_0 through I/O_{15}) are placed in a high-impedance state when: deselected (\overline{CE} HIGH), outputs are disabled (\overline{OE} HIGH), both Byte High Enable and Byte Low Enable are disabled (\overline{BHE} , \overline{BLE} HIGH), or during a write operation (\overline{CE} LOW and \overline{WE} LOW).

Writing to the device is accomplished by taking Chip Enable (\overline{CE}) and Write Enable (\overline{WE}) inputs LOW. If Byte Low Enable (\overline{BLE}) is LOW, then data from I/O pins (I/O_0 through I/O_7), is written into the location specified on the address pins (A_0 through A_{16}). If Byte High Enable (\overline{BHE}) is LOW, then data from I/O pins (I/O_8 through I/O_{15}) is written into the location specified on the address pins (A_0 through A_{16}).

Reading from the device is accomplished by taking Chip Enable (\overline{CE}) and Output Enable (\overline{OE}) LOW while forcing the Write Enable (\overline{WE}) HIGH. If Byte Low Enable (\overline{BLE}) is LOW, then data from the memory location specified by the address pins will appear on I/O_0 to I/O_7 . If Byte High Enable (\overline{BHE}) is LOW, then data from memory will appear on I/O_8 to I/O_{15} . See the truth table at the back of this data sheet for a complete description of read and write modes.

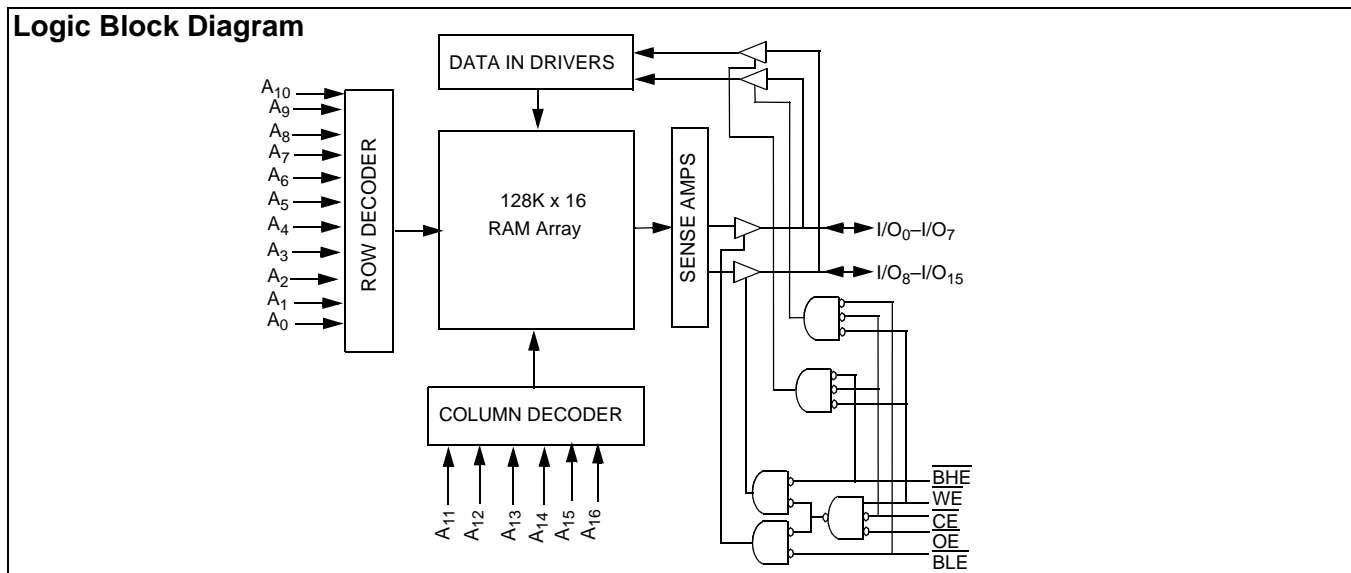

Note:

1. For best practice recommendations, please refer to the Cypress application note "System Design Guidelines" on <http://www.cypress.com>.

Pin Configuration^[2, 3]

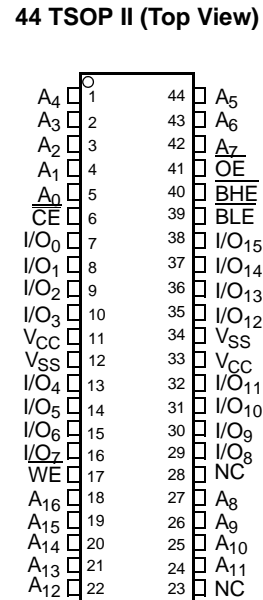
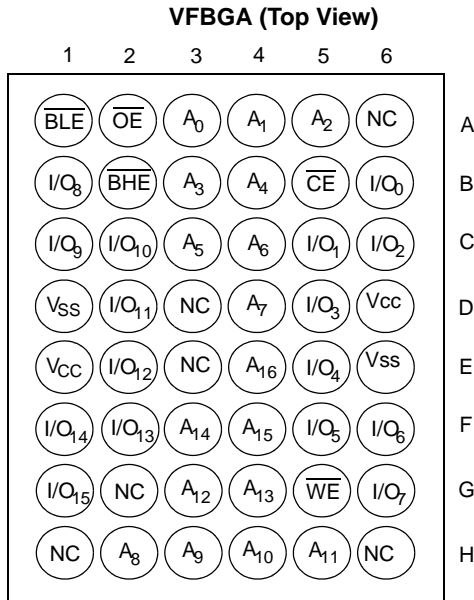

Product Portfolio^[4]

Product	V _{CC} Range (V)			Speed (ns)	Power Dissipation					
					Operating I _{CC} (mA)				Standby I _{SB2} (μA)	
					f = 1MHz		f = f _{max}			
Min.	Typ. ^[4]	Max.	Typ. ^[4]	Max.	Typ. ^[4]	Max.	Typ. ^[4]	Max.		
CY62136EV30LL	2.2	3.0	3.6	45	2	2.5	15	20	1	7

Notes:

- NC pins are not connected on the die.
- Pins D3, H1, G2, and H6 in the BGA package are address expansion pins for 4 Mbit, 8 Mbit, 16 Mbit and 32 Mbit, respectively.
- Typical values are included for reference only and are not guaranteed or tested. Typical values are measured at V_{CC} = V_{CC(typ.)}, T_A = 25°C.

Maximum Ratings

(Above which the useful life may be impaired. For user guidelines, not tested.)

- Storage Temperature -65°C to + 150°C
- Ambient Temperature with Power Applied -55°C to + 125°C
- Supply Voltage to Ground Potential -0.3V to 3.9V ($V_{CC\ MAX} + 0.3V$)
- DC Voltage Applied to Outputs in High-Z State^[5,6] -0.3V to 3.9V ($V_{CC\ MAX} + 0.3V$)

- DC Input Voltage^[5,6] -0.3V to 3.9V ($V_{CC\ MAX} + 0.3V$)
 - Output Current into Outputs (LOW) 20 mA
 - Static Discharge Voltage > 2001V (per MIL-STD-883, Method 3015)
 - Latch-up Current > 200 mA
- Operating Range^[7]**

Device	Range	Ambient Temperature	V_{CC} ^[7]
CY62136EV30LL	Industrial	-40°C to +85°C	2.2V - 3.6V

Electrical Characteristics Over the Operating Range^[5, 6, 7]

Parameter	Description	Test Conditions	45 ns			Unit
			Min.	Typ. ^[4]	Max.	
V _{OH}	Output HIGH Voltage	I _{OH} = -0.1 mA, V _{CC} = 2.20V	2.0			V
		I _{OH} = -1.0 mA, V _{CC} = 2.70V	2.4			V
V _{OL}	Output LOW Voltage	I _{OL} = 0.1 mA, V _{CC} = 2.20V			0.4	V
		I _{OL} = 2.1 mA, V _{CC} = 2.70V			0.4	V
V _{IH}	Input HIGH Voltage	V _{CC} = 2.2V to 2.7V	1.8		V _{CC} + 0.3	V
		V _{CC} = 2.7V to 3.6V	2.2		V _{CC} + 0.3	V
V _{IL}	Input LOW Voltage	V _{CC} = 2.2V to 2.7V	-0.3		0.6	V
		V _{CC} = 2.7V to 3.6V	-0.3		0.8	V
I _{IX}	Input Leakage Current	GND ≤ V _I ≤ V _{CC}	-1		+1	μA
I _{OZ}	Output Leakage Current	GND ≤ V _O ≤ V _{CC} , Output Disabled	-1		+1	μA
I _{CC}	V _{CC} Operating Supply Current	f = f _{MAX} = 1/t _{RC} , V _{CC} = V _{CCmax} , I _{OUT} = 0 mA, CMOS levels		15	20	mA
		f = 1 MHz		2	2.5	
I _{SB1}	Automatic CE Power-down Current — CMOS Inputs	CE ≥ V _{CC} - 0.2V, V _{IN} ≥ V _{CC} - 0.2V, V _{IN} ≤ 0.2V, f = f _{MAX} (Address and Data Only), f = 0 (OE, and WE), V _{CC} = 3.60V		1	7	μA
I _{SB2}	Automatic CE Power-down Current — CMOS Inputs	CE ≥ V _{CC} - 0.2V, V _{IN} ≥ V _{CC} - 0.2V or V _{IN} ≤ 0.2V, f = 0, V _{CC} = 3.60V		1	7	μA

Capacitance (for all packages)^[8]

Parameter	Description	Test Conditions	Max.	Unit
C _{IN}	Input Capacitance	T _A = 25°C, f = 1 MHz, V _{CC} = V _{CC(typ)}	10	pF
C _{OUT}	Output Capacitance		10	pF

Notes:

5. V_{IL(min.)} = -2.0V for pulse durations less than 20 ns.
6. V_{IH(max.)} = V_{CC} + 0.75V for pulse durations less than 20ns.
7. Full Device AC operation assumes a 100 μs ramp time from 0 to V_{CC(min)} and 200 μs wait time after V_{CC} stabilization.
8. Tested initially and after any design or process changes that may affect these parameters.

Thermal Resistance^[8]

Parameter	Description	Test Conditions	VFBGA Package	TSOP II Package	Unit
Θ_{JA}	Thermal Resistance (Junction to Ambient) ^[8]	Still Air, soldered on a 3 x 4.5 inch, two-layer printed circuit board	75	77	°C/W
Θ_{JC}	Thermal Resistance (Junction to Case) ^[8]		10	13	°C/W

AC Test Loads and Waveforms

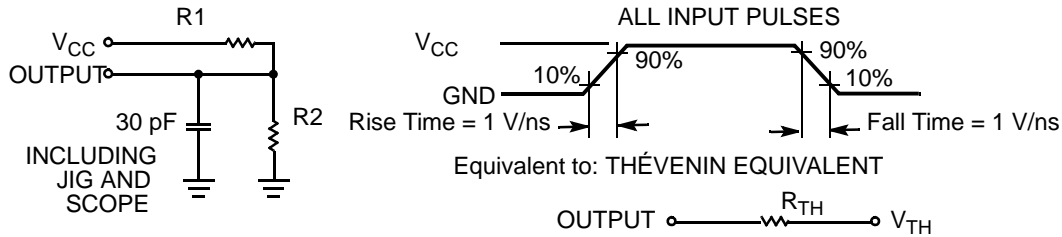

Parameters	2.50V	3.0V	Unit
R1	16667	1103	Ω
R2	15385	1554	Ω
R_{TH}	8000	645	Ω
V_{TH}	1.20	1.75	V

Data Retention Characteristics (Over the Operating Range)^[8, 9]

Parameter	Description	Conditions	Min.	Typ. ^[4]	Max.	Unit
V_{DR}	V_{CC} for Data Retention		1.0			V
I_{CCDR}	Data Retention Current	$V_{CC} = 1.0V$ $CE \geq V_{CC} - 0.2V$, $V_{IN} \geq V_{CC} - 0.2V$ or $V_{IN} \leq 0.2V$		0.8	3	μA
$t_{CDR}^{[8]}$	Chip Deselect to Data Retention Time		0			ns
$t_R^{[9]}$	Operation Recovery Time		t_{RC}			ns

Data Retention Waveform

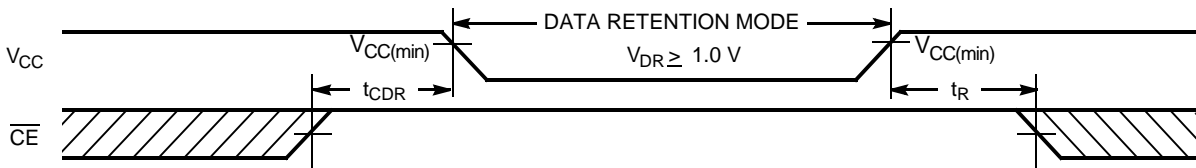

Notes:

9. Full device operation requires linear V_{CC} ramp from V_{DR} to $V_{CC(min.)} \geq 100 \mu s$ or stable at $V_{CC(min.)} \geq 100 \mu s$.

Switching Characteristics Over the Operating Range [10, 11, 12, 13]

Parameter	Description	45 ns		Unit
		Min.	Max.	
Read Cycle				
t_{RC}	Read Cycle Time	45		ns
t_{AA}	Address to Data Valid		45	ns
t_{OHA}	Data Hold from Address Change	10		ns
t_{ACE}	\overline{CE} LOW to Data Valid		45	ns
t_{DOE}	\overline{OE} LOW to Data Valid		22	ns
t_{LZOE}	\overline{OE} LOW to Low Z ^[11]	5		ns
t_{HZOE}	\overline{OE} HIGH to High Z ^[11, 12]		18	ns
t_{LZCE}	\overline{CE} LOW to Low Z ^[11]	10		ns
t_{HZCE}	\overline{CE} HIGH to High Z ^[11, 12]		18	ns
t_{PU}	\overline{CE} LOW to Power-Up	0		ns
t_{PD}	\overline{CE} HIGH to Power-Down		45	ns
t_{DBE}	$\overline{BLE}/\overline{BHE}$ LOW to Data Valid		22	ns
t_{LZBE}	$\overline{BLE}/\overline{BHE}$ LOW to Low Z ^[11]	5		ns
t_{HZBE}	$\overline{BLE}/\overline{BHE}$ HIGH to HIGH Z ^[11, 12]		18	ns
Write Cycle^[13]				
t_{WC}	Write Cycle Time	45		ns
t_{SCE}	\overline{CE} LOW to Write End	35		ns
t_{AW}	Address Set-Up to Write End	35		ns
t_{HA}	Address Hold from Write End	0		ns
t_{SA}	Address Set-Up to Write Start	0		ns
t_{PWE}	\overline{WE} Pulse Width	35		ns
t_{BW}	$\overline{BLE}/\overline{BHE}$ LOW to Write End	35		ns
t_{SD}	Data Set-Up to Write End	25		ns
t_{HD}	Data Hold from Write End	0		ns
t_{HZWE}	\overline{WE} LOW to High-Z ^[11, 12]		18	ns
t_{LZWE}	\overline{WE} HIGH to Low-Z ^[11]	10		ns

Notes:

10. Test conditions for all parameters other than tri-state parameters assume signal transition time of 3 ns (1V/ns) or less, timing reference levels of $V_{CC(typ)}/2$, input pulse levels of 0 to $V_{CC(typ)}$, and output loading of the specified I_{OL}/I_{OH} as shown in the "AC Test Loads and Waveforms" section.
11. At any given temperature and voltage condition, t_{HZCE} is less than t_{LZCE} , t_{HZBE} is less than t_{LZBE} , t_{HZOE} is less than t_{LZOE} , and t_{HZWE} is less than t_{LZWE} for any given device.
12. t_{HZOE} , t_{HZCE} , t_{HZBE} , and t_{HZWE} transitions are measured when the outputs enter a high impedance state.
13. The internal Write time of the memory is defined by the overlap of \overline{WE} , $\overline{CE} = V_{IL}$, \overline{BHE} and/or $\overline{BLE} = V_{IL}$. All signals must be ACTIVE to initiate a write and any of these signals can terminate a write by going INACTIVE. The data input set-up and hold timing should be referenced to the edge of the signal that terminates the write.

Switching Waveforms [14, 15]

Read Cycle 1 (Address Transition Controlled)[14, 15]

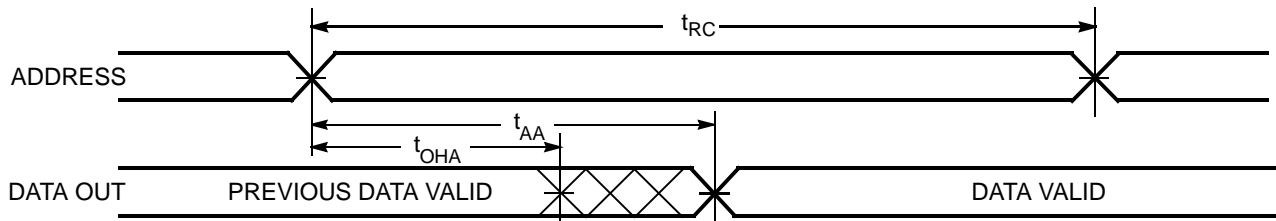

Read Cycle No. 2 (\overline{OE} Controlled)[15, 16]

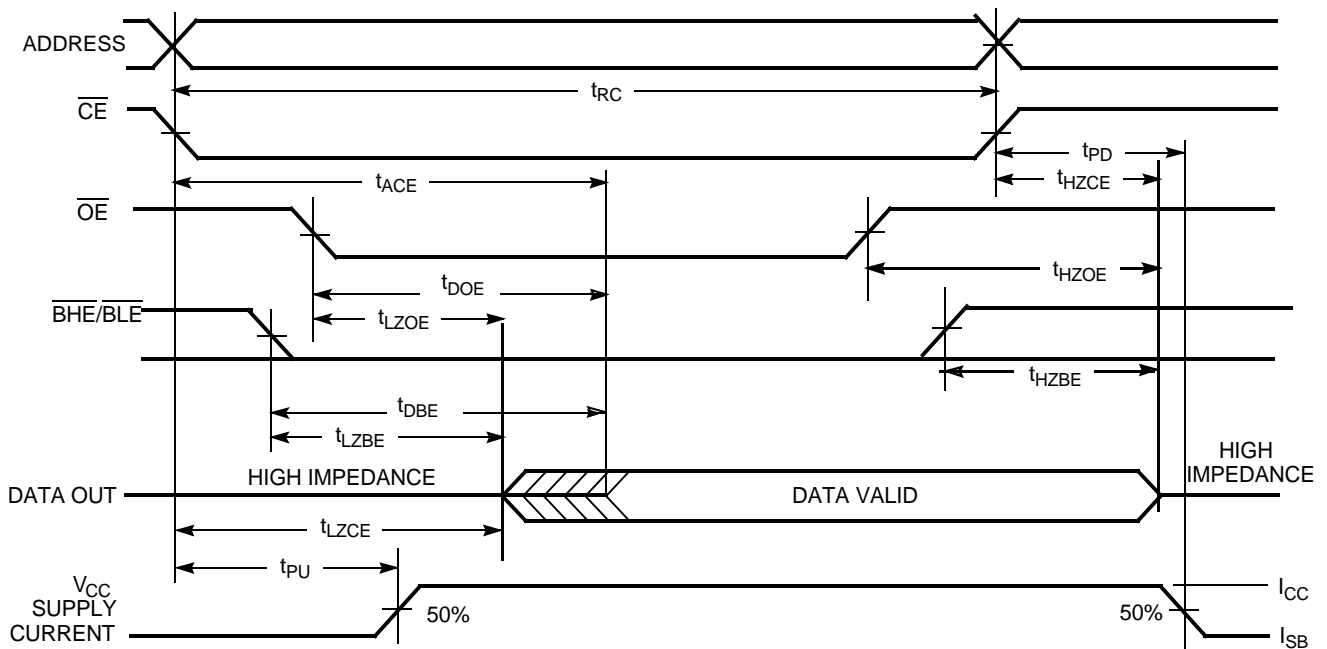

- Notes:**
 14. The device is continuously selected. \overline{OE} , $\overline{CE} = V_{IL}$, \overline{BHE} and/or $\overline{BLE} = V_{IL}$.
 15. \overline{WE} is HIGH for read cycle.
 16. Address valid prior to or coincident with \overline{CE} and \overline{BHE} , \overline{BLE} transition LOW.

Switching Waveforms (continued)^[14, 15]

Write Cycle No. 1 (WE Controlled)^[13, 17, 18]

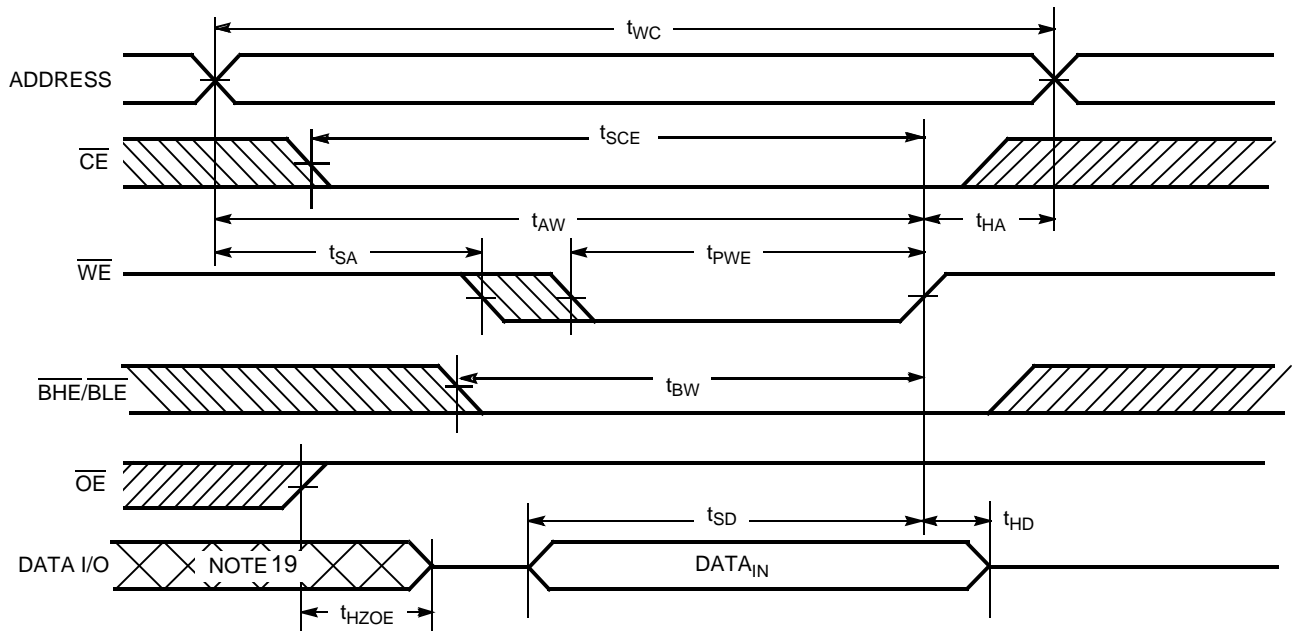

Write Cycle No. 2 (CE Controlled)^[13, 17, 18]

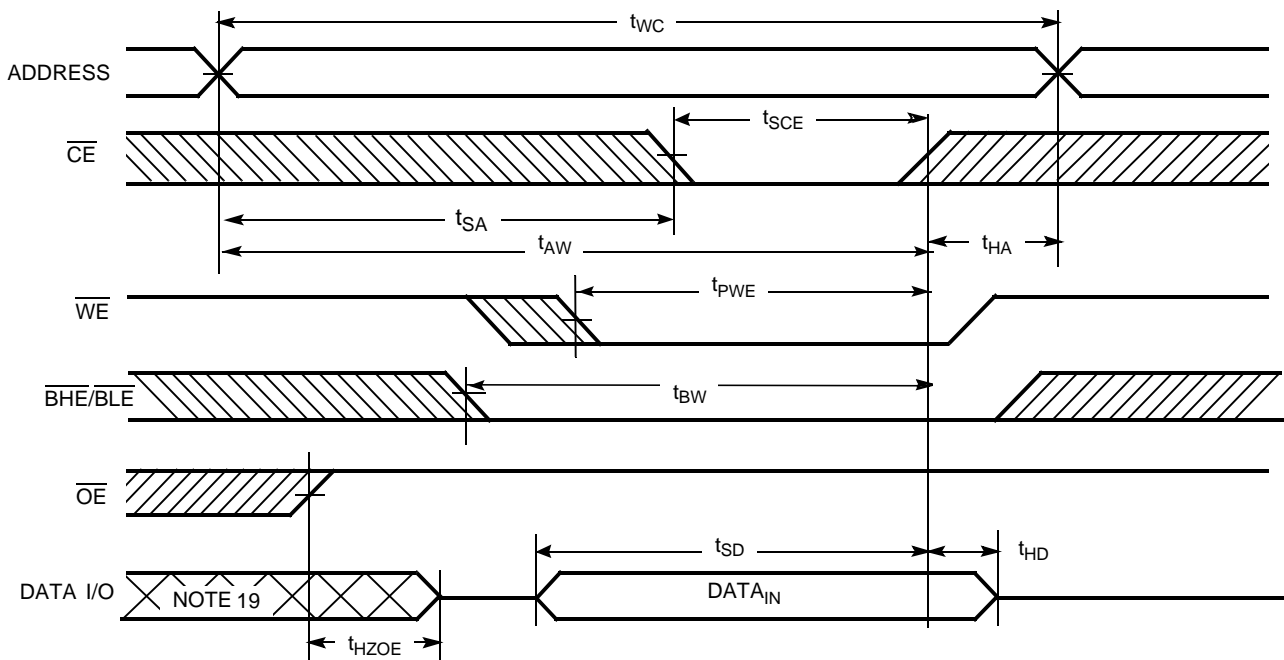

Notes:

- 17. Data I/O is high impedance if $\overline{OE} = V_{IH}$.
- 18. If \overline{CE} goes HIGH simultaneously with $\overline{WE} = V_{IH}$, the output remains in a high-impedance state.
- 19. During this period, the I/Os are in output state and input signals should not be applied.

Switching Waveforms (continued)^[14, 15]

Write Cycle No. 3 (\overline{WE} Controlled, \overline{OE} LOW)^[18]

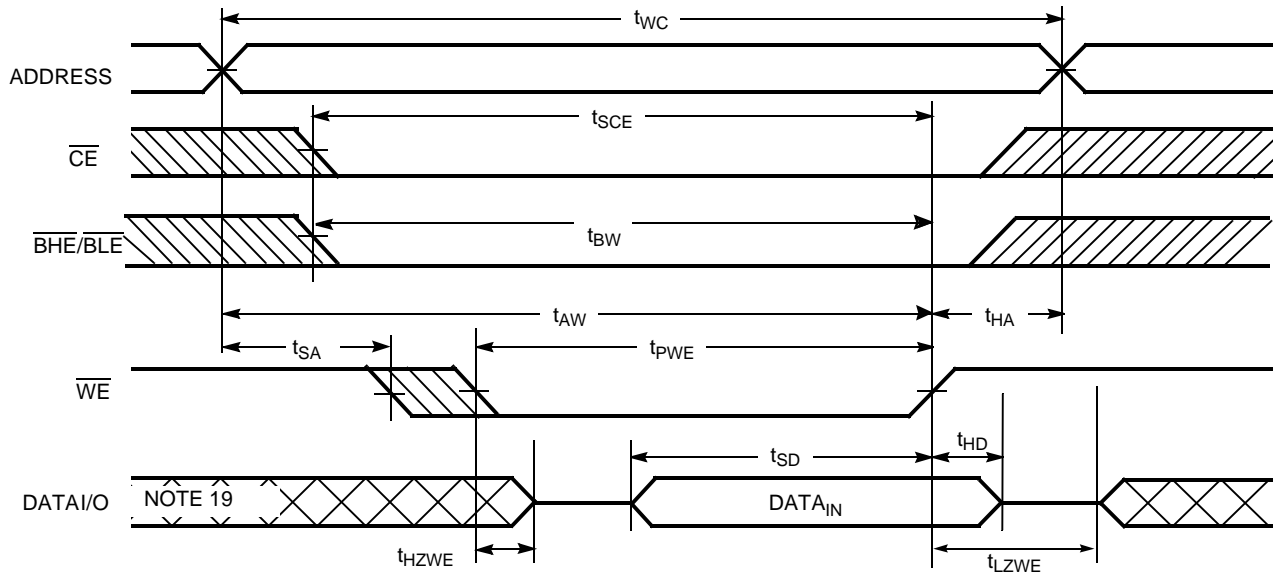

Write Cycle No. 4 ($\overline{BHE}/\overline{BLE}$ Controlled, \overline{OE} LOW)^[18]

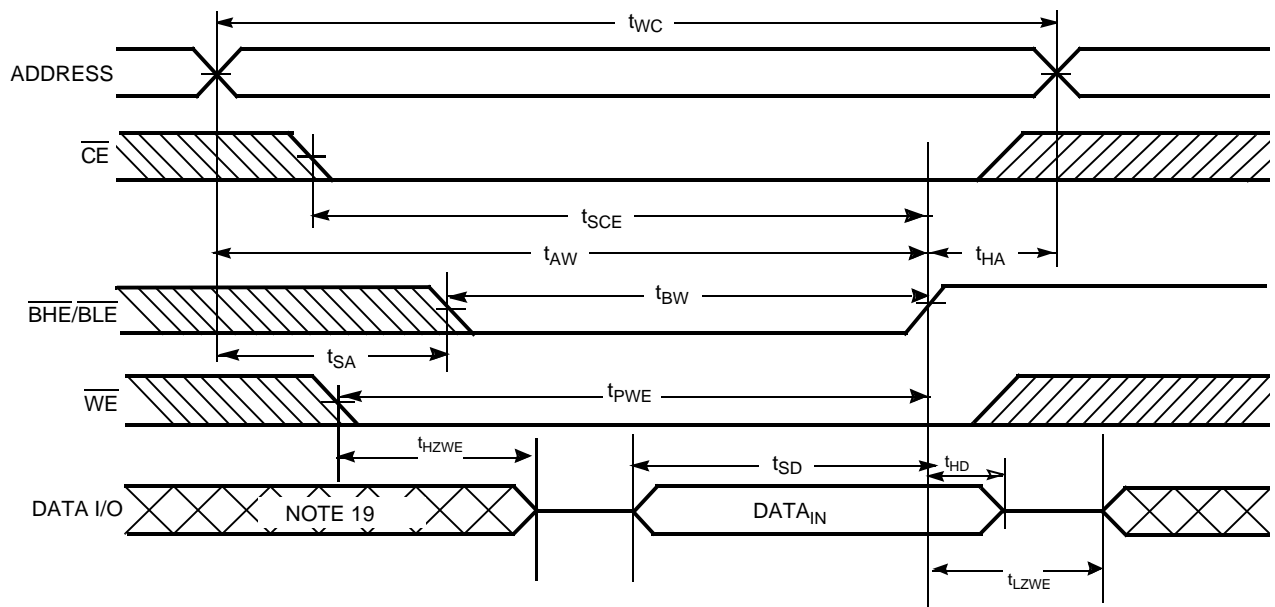

Truth Table

\overline{CE}	\overline{WE}	\overline{OE}	\overline{BHE}	\overline{BLE}	Inputs/Outputs	Mode	Power
H	X	X	X	X	High Z	Deselect/Power-down	Standby (I_{SB})
L	X	X	H	H	High Z	Output Disabled	Active (I_{CC})
L	H	L	L	L	Data Out (I/O_0 – I/O_{15})	Read	Active (I_{CC})
L	H	L	H	L	Data Out (I/O_0 – I/O_7); I/O_8 – I/O_{15} in High Z	Read	Active (I_{CC})
L	H	L	L	H	Data Out (I/O_8 – I/O_{15}); I/O_0 – I/O_7 in High Z	Read	Active (I_{CC})
L	H	H	L	L	High Z	Output Disabled	Active (I_{CC})
L	H	H	H	L	High Z	Output Disabled	Active (I_{CC})
L	H	H	L	H	High Z	Output Disabled	Active (I_{CC})
L	L	X	L	L	Data In (I/O_0 – I/O_{15})	Write	Active (I_{CC})
L	L	X	H	L	Data In (I/O_0 – I/O_7); I/O_8 – I/O_{15} in High Z	Write	Active (I_{CC})
L	L	X	L	H	Data In (I/O_8 – I/O_{15}); I/O_0 – I/O_7 in High Z	Write	Active (I_{CC})

Ordering Information

Speed (ns)	Ordering Code	Package Diagram	Package Type	Operating Range
45	CY62136EV30LL-45BVXI	51-85150	48-ball Very Fine Pitch Ball Grid Array (Pb-free)	Industrial
	CY62136EV30LL-45ZSXI	51-85087	44-pin Thin Small Outline Package II (Pb-free)	

Please contact your local Cypress sales representative for availability of other parts

Package Diagrams

48-pin VFBGA (6 x 8 x 1 mm) (51-85150)

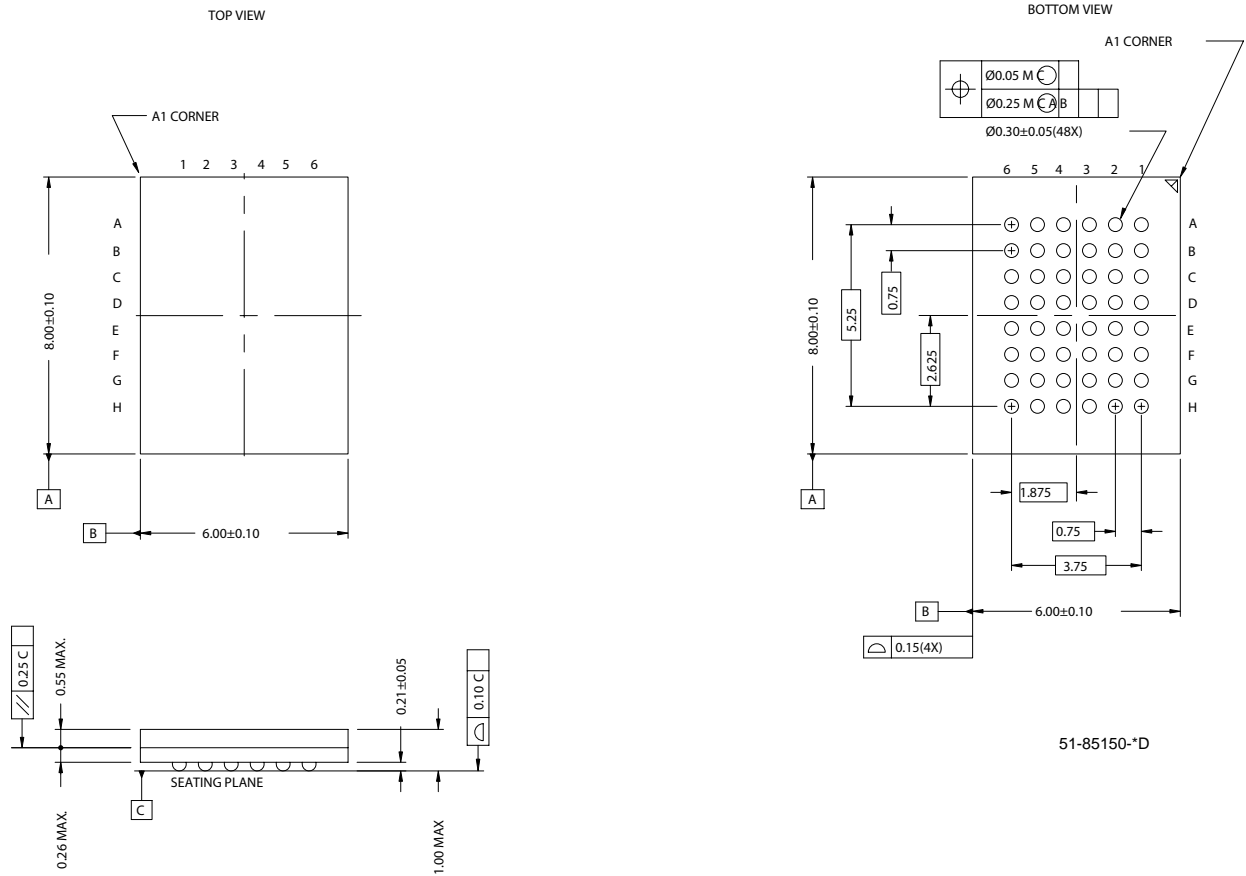

Package Diagrams (continued)

44-pin TSOP II (51-85087)

DIMENSION IN MM (INCH)
MAX
MIN

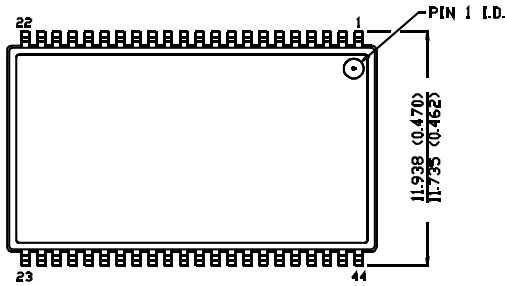

TOP VIEW

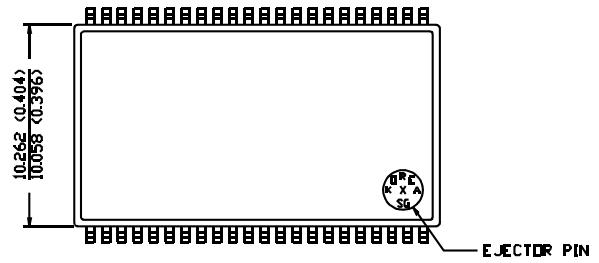

BOTTOM VIEW

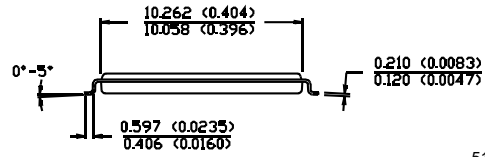
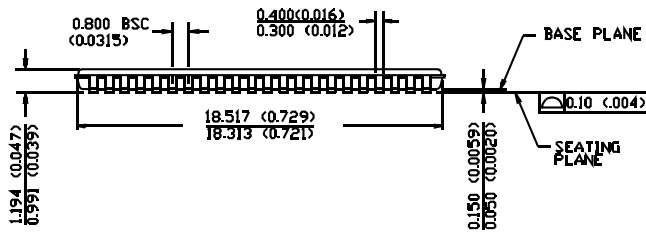

51-85087-*A

MoBL is a registered trademark, and More Battery Life is a trademark, of Cypress Semiconductor. All product and company names mentioned in this document may be the trademarks of their respective holders.

Document History Page

Document Title: CY62136EV30 MoBL® 2-Mbit (128K x 16) Static RAM Document Number: 38-05569				
REV.	ECN NO.	Issue Date	Orig. of Change	Description of Change
**	237432	See ECN	AJU	New Data Sheet
*A	419988	See ECN	RXU	<p>Converted from Advanced Information to Final.</p> <p>Changed the address of Cypress Semiconductor Corporation on Page #1 from "3901 North First Street" to "198 Champion Court"</p> <p>Removed 35ns Speed Bin</p> <p>Removed "L" version of CY62136EV30</p> <p>Changed I_{CC} (Max) value from 2 mA to 2.5 mA and I_{CC} (Typ) value from 1.5 mA to 2 mA at f=1 MHz</p> <p>Changed I_{CC} (Typ) value from 12 mA to 15 mA at f = f_{max}</p> <p>Changed I_{SB1} and I_{SB2} Typ. values from 0.7 μA to 1 μA and Max. values from 2.5 μA to 7 μA.</p> <p>Changed the AC test load capacitance from 50pF to 30pF on Page# 4</p> <p>Changed V_{DR} from 1.5V to 1V on Page# 4.</p> <p>Changed I_{CCDR} from 2.5 μA to 3 μA.</p> <p>Added I_{CCDR} typical value.</p> <p>Changed t_{OHA}, t_{LZCE} and t_{LZWE} from 6 ns to 10 ns</p> <p>Changed t_{LZBE} from 6 ns to 5 ns</p> <p>Changed t_{LZOE} from 3 ns to 5 ns</p> <p>Changed t_{HZOE}, t_{HZCE}, t_{HZBE} and t_{HZWE} from 15 ns to 18 ns</p> <p>Changed t_{SCE}, t_{AW} and t_{BW} from 40 ns to 35 ns</p> <p>Changed t_{PWE} from 30 ns to 35 ns</p> <p>Changed t_{SD} from 20 ns to 25 ns</p> <p>Corrected typo in the Truth Table on Page# 9</p> <p>Updated the package diagram 48-pin VFBGA from *B to *D</p> <p>Updated the ordering Information table and replaced the Package Name column with Package Diagram.</p>
*B	427817	See ECN	NXR	Minor change: Moved datasheet to external web