

IEC Appliance Inlet C14 with Fuseholder 1- or 2-pole and Voltage Selector

Standard or Medical Fuse drawer



Fuse drawer must be ordered separately (see accessories).

Fuse drawer must be ordered separately (see accessories).



Description

- Panel Mount:
Screw-on version from front or rear side, snap-in version from front side
- 3 Functions:
Appliance Inlet Protection class I, Fuseholder with interchangeable fuse drawer for Fuse-links 5 x 20 mm or 6.3 x 32 mm 1- or 2-pole, with or without voltage selector (step switch)
- Quick connect terminals 4.8 x 0.8 mm
- Alternative: version with line filter **KFC**

Approvals

- VDE License Number: 40030345
- UL License Number: E93617
- CSA License Number: 38456

Characteristics

- Available with or without internal connections
- The fuse drawer "Fingergrip" can be removed by hand
For added safety "Extra-Safe" fuse drawers are available
Fuse drawer meets requirements of medical standard IEC/EN 60601-1
The fuse drawer can only be opened with the aid of a tool
The fuseholder is accessible from the equipment front
- Qualified for use in equipment according IEC/EN 60950

Other versions on request

- Fuse drawer with other voltage values
- For protection class II

References

[General Product Information](#)

Weblinks

[Approvals](#), [RoHS](#), [CHINA-RoHS](#), [Mating Connectors](#), [Distributor-Stock-Check](#), [Accessories](#)

Technical Data

Ratings IEC	10A / 250VAC; 50Hz	Appliance Inlet	C14 acc. to IEC/EN 60320-1, UL 498, CSA C22.2 no. 42 (for cold conditions) pin-temperature 70 °C, 10A, Protection Class 1
Ratings UL/CSA	13A / 125VAC; 60Hz 1)	Fuseholder	1 or 2 pole, Shocksafe category PC2 acc. to IEC 60127-6, for fuse-links 5 x 20 or 6.3 x 32mm
Dielectric Strength	> 3kVAC between L-N > 4kVAC between L/N-PE (1 min/50Hz)	Rated Power Acceptance @ Ta 23 °C	5 x 20: 2.5W (1 pole)/ 2W (2-pole) per pole 6.3 x 32: 3.15W (1 pole)/ 2.5W (2-pole) per pole
Allowable Operation Temp.	-25 °C to 70 °C	Power Acceptance @ Ta > 23 °C	Admissible power acceptance at higher ambient temperature see derating curves
Degree of Protection	from front side IP 40 acc. to IEC 60529	Voltage Selectors	optional, step, 2-4 digits
Protection Class	Suitable for appliances with protection class 1 acc. to IEC 61140		
Terminal	Quick connect terminals 4.8 x 0.8 mm		
Panel Thickness s	Screw: max 8 mm Mounting screw torque max 0.5 Nm Snap-in: 1.5/2/2.5 mm		
Material: Housing	Thermoplastic, black, UL 94V-0		

1) UL/CSA: 1-pole version 13 A, 2-pole version 10 A

Dimensions

Screw on PCB mounting

Snap-in mounting

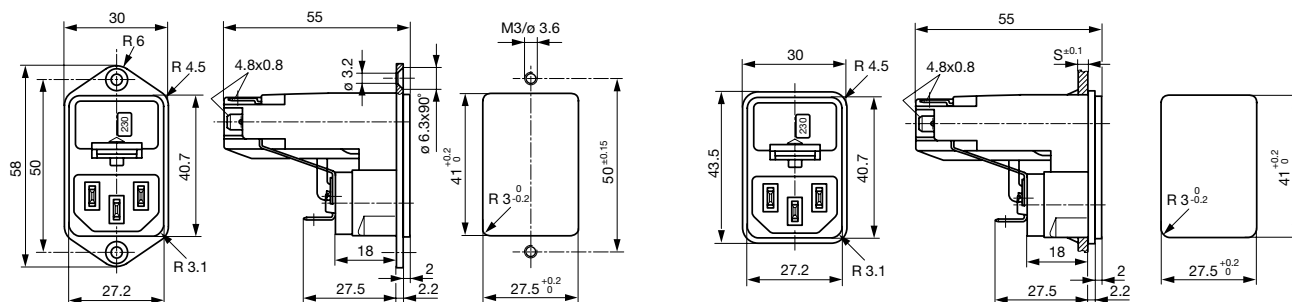

Diagrams

without internal connections
Voltage selector
4-positions, 1-pole

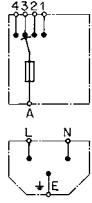

without internal connections
Voltage selector
4-positions, 2-pole

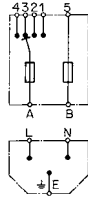

with internal connections
Voltage selector
4-positions, 1-pole

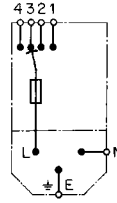

with internal connections
Voltage selector
4-positions, 2-pole

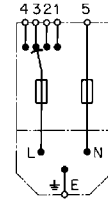

Voltage selector
3-positions
1-pole



Voltage selector
3-positions
2-pole



Voltage selector
2-positions
1-pole



Voltage selector
2-positions
2-pole



without voltage selector
1-pole



without voltage selector
2-pole



Derating Curves

Fuses
5 x 20 mm (1-pole)

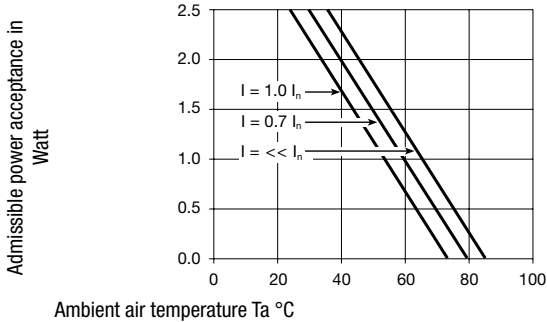

Fuses
5 x 20 mm (2-pole, per pole)

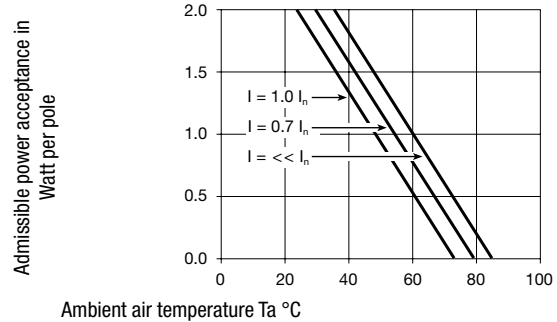

Fuses
6.3 x 32 mm (1-pole)

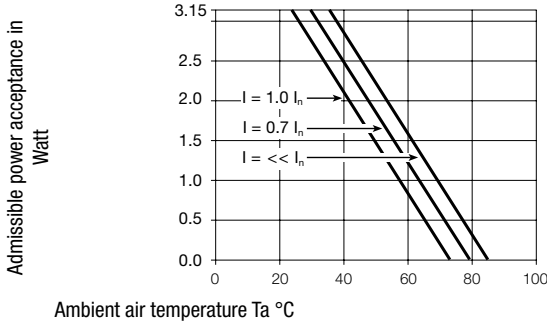

Fuses
6.3 x 32 mm (2-pole, per pole)

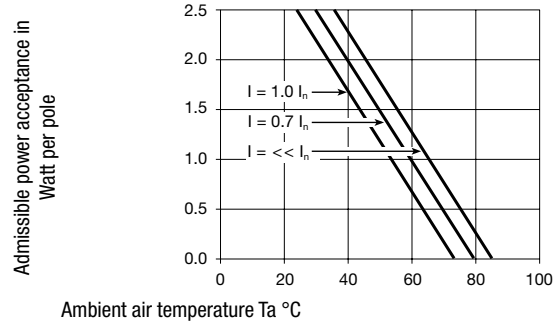

Variants

Fuse drawer must be ordered separately (see accessories).

Fingerrip and Extra-Safe

Panel mounting	Panel Thickness s [mm]	Fuseholder	Voltage Selectors	Internally wired	Order Number
Screw	-	1-pole	without	●	4303.0031
Screw	-	1-pole	3/4 digits	●	4303.0091
Screw	-	1-pole	2 pos.	●	4303.0211
Screw	-	1-pole	without		4303.1031
Screw	-	1-pole	3/4 digits		4303.1091
Screw	-	1-pole	2 pos.		4303.1211
Screw	-	2-pole	without	●	4303.0001
Screw	-	2-pole	3/4 digits	●	4303.0061
Screw	-	2-pole	2 pos.	●	4303.0181
Screw	-	2-pole	without		4303.1001
Screw	-	2-pole	3/4 digits		4303.1061
Screw	-	2-pole	2 pos.		4303.1181
Snap-in	1.5	1-pole	without	●	4303.0032
Snap-in	1.5	1-pole	3/4 digits	●	4303.0092
Snap-in	1.5	1-pole	2 pos.	●	4303.0212
Snap-in	2	1-pole	without	●	4303.0033
Snap-in	2	1-pole	3/4 digits	●	4303.0093
Snap-in	2	1-pole	2 pos.	●	4303.0213
Snap-in	2.5	1-pole	without	●	4303.0034
Snap-in	2.5	1-pole	3/4 digits	●	4303.0094
Snap-in	2.5	1-pole	2 pos.	●	4303.0214
Snap-in	1.5	1-pole	without		4303.1032
Snap-in	1.5	1-pole	3/4 digits		4303.1092
Snap-in	1.5	1-pole	2 pos.		4303.1212
Snap-in	2	1-pole	without		4303.1033
Snap-in	2	1-pole	3/4 digits		4303.1093
Snap-in	2	1-pole	2 pos.		4303.1213
Snap-in	2.5	1-pole	without		4303.1034
Snap-in	2.5	1-pole	3/4 digits		4303.1094
Snap-in	2.5	1-pole	2 pos.		4303.1214
Snap-in	1.5	2-pole	without	●	4303.0002
Snap-in	1.5	2-pole	3/4 digits	●	4303.0062
Snap-in	1.5	2-pole	2 pos.	●	4303.0182
Snap-in	2	2-pole	without	●	4303.0003
Snap-in	2	2-pole	3/4 digits	●	4303.0063
Snap-in	2	2-pole	2 pos.	●	4303.0183
Snap-in	2.5	2-pole	without	●	4303.0004
Snap-in	2.5	2-pole	3/4 digits	●	4303.0064
Snap-in	2.5	2-pole	2 pos.	●	4303.0184
Snap-in	1.5	2-pole	without		4303.1002
Snap-in	1.5	2-pole	3/4 digits		4303.1062
Snap-in	1.5	2-pole	2 pos.		4303.1182
Snap-in	2	2-pole	without		4303.1003
Snap-in	2	2-pole	3/4 digits		4303.1063
Snap-in	2	2-pole	2 pos.		4303.1183
Snap-in	2.5	2-pole	without		4303.1004
Snap-in	2.5	2-pole	3/4 digits		4303.1064
Snap-in	2.5	2-pole	2 pos.		4303.1184

Packaging unit 50 Pcs

Required Accessory

Description

Fusedrawer 3

Fusedrawer for Fuse Links 5x20mm resp.. 6.3x32mm



Fingergrip, 5 x 20, 2-pole, Voltage Selectors	4303.2014.00
Fingergrip, 5 x 20, 2-pole, Voltage Selectors, 100, 120, 220, 240	4303.2014.01
Fingergrip, 5 x 20, 2-pole, Voltage Selectors, 110, 150, 220	4303.2014.02
Fingergrip, 5 x 20, 2-pole, Voltage Selectors, 110, 220	4303.2014.03
...	...

Accessories

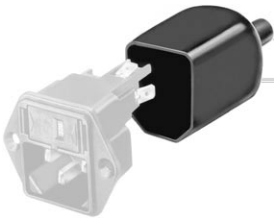

Assorted Covers

Rear Cover

0859.0072



Cord retaining kits

Cord retaining strain relief

Flat head, A

4700.0001

Mating Outlets/Connectors

Category / Description

Appliance Outlet Overview complete



IEC Appliance Outlet F, Screw-on Mounting, Front Side, Solder Terminal	4787
IEC Appliance Outlet F, Snap-in Mounting, Front Side, Solder or Quick-connect Terminal	4788
IEC Appliance Outlet F or H, Screw-on Mounting, Front Side, Solder, PCB or Quick-connect Terminal	5091
IEC Appliance Outlet F or H, Screw-on Mounting, Front Side, Solder or Quick-connect Terminal	5092

[Appliance Outlet further types to KEC](#)

Connector Overview complete



IEC Connector C15, Rewireable, Straight	0101
IEC Connector C15A, Rewireable, Straight	0102
IEC Connector C15A, Rewireable, Straight	0102-G
IEC Connector C15A, Rewireable, Angled	0112
IEC Connector C13, Rewireable, Angled	4012

[Connector further types to KEC](#)

Power Cord Overview complete



Power Cord with IEC Connector C13, Angled	0311
Power Cord with IEC Connector C13, Angled	3011
Power Cord with IEC Connector C13, Angled	3012
Power Cord with IEC Connector C13, Angled	3013
Power Cord with IEC Connector C13	3020

[Power Cord further types to KEC](#)